

## Dual Common-Cathode Schottky Rectifier

TO-220AB

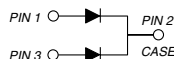
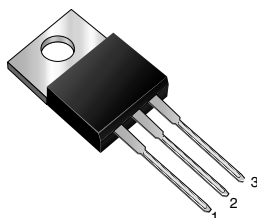

### FEATURES

- Guardring for overvoltage protection
- Lower power losses, high efficiency
- Low forward voltage drop
- High forward surge capability
- High frequency operation
- Solder dip 260 °C, 40 s
- Component in accordance to RoHS 2002/95/EC and WEEE 2002/96/EC



**RoHS**  
COMPLIANT

### TYPICAL APPLICATIONS

For use in low voltage, high frequency rectifier of switching mode power supplies, freewheeling diodes, dc-to-dc converters or polarity protection applications.

### PRIMARY CHARACTERISTICS

$I_{F(AV)}$	2 x 15 A
$V_{RRM}$	40 V
$E_{AS}$	20 mJ
$I_{FSM}$	280 A
$V_F$ at $I_F = 15$ A	0.413 V
$T_J$ max.	150 °C

### MECHANICAL DATA

**Case:** TO-220AB

Epoxy meets UL 94V-0 flammability rating

**Terminals:** Matte tin plated leads, solderable per J-STD-002 and JESD22-B102

E3 suffix for consumer grade, meets JESD 201 class 1A whisker test

**Polarity:** As marked

**Mounting Torque:** 10 in-lbs maximum

### MAXIMUM RATINGS ( $T_A = 25$ °C unless otherwise noted)

PARAMETER	SYMBOL	M30L40C	UNIT
Maximum repetitive peak reverse voltage	$V_{RRM}$	40	V
Maximum average forward rectified current (Fig. 1)	$I_{F(AV)}$	30 15	A
Peak forward surge current 8.3 ms single half sine-wave superimposed on rated load per diode	$I_{FSM}$	280	A
Peak repetitive reverse current per diode at $t_p = 2$ $\mu$ s, 1 kHz	$I_{RRM}$	1.0	A
Non-repetitive avalanche energy at 25 °C, $I_{AS} = 2$ A, $L = 10$ mH per diode	$E_{AS}$	20	mJ
Voltage rate of change (rated $V_R$ )	dV/dt	10 000	V/ $\mu$ s
Operating junction and storage temperature range	$T_J, T_{STG}$	- 65 to + 150	°C



ELECTRICAL CHARACTERISTICS ( $T_A = 25\text{ }^\circ\text{C}$ unless otherwise noted)						
PARAMETER	TEST CONDITIONS		SYMBOL	TYP.	MAX.	UNIT
Instantaneous forward voltage per diode <sup>(1)</sup>	$I_F = 8\text{ A}$ $I_F = 15\text{ A}$ $I_F = 30\text{ A}$	$T_J = 25\text{ }^\circ\text{C}$	$V_F$	0.430 0.490 0.595	- 0.55 -	V
	$I_F = 8\text{ A}$ $I_F = 15\text{ A}$ $I_F = 30\text{ A}$	$T_J = 125\text{ }^\circ\text{C}$		0.331 0.413 0.572	- 0.48 -	
Reverse current per diode <sup>(2)</sup>	$V_R = 40\text{ V}$	$T_J = 25\text{ }^\circ\text{C}$ $T_J = 100\text{ }^\circ\text{C}$	$I_R$	88 12	360 45	$\mu\text{A}$ mA
Typical junction capacitance per diode	4.0 V, 1 MHz		$C_J$	750	-	pF

**Notes:**

- (1) Pulse test: 300  $\mu\text{s}$  pulse width, 1 % duty cycle
- (2) Pulse test: Pulse width  $\leq 40\text{ ms}$

THERMAL CHARACTERISTICS ( $T_A = 25\text{ }^\circ\text{C}$ unless otherwise noted)			
PARAMETER	SYMBOL	M30L40C	UNIT
Typical thermal resistance per diode	$R_{\theta JC}$	2.0	$^\circ\text{C/W}$

ORDERING INFORMATION (Example)				
PREFERRED P/N	UNIT WEIGHT (g)	PREFERRED PACKAGE CODE	BASE QUANTITY	DELIVERY MODE
M30L40C-E3/4W	2.068	4W	50/tube	Tube

**RATINGS AND CHARACTERISTICS CURVES**

( $T_A = 25\text{ }^\circ\text{C}$  unless otherwise noted)

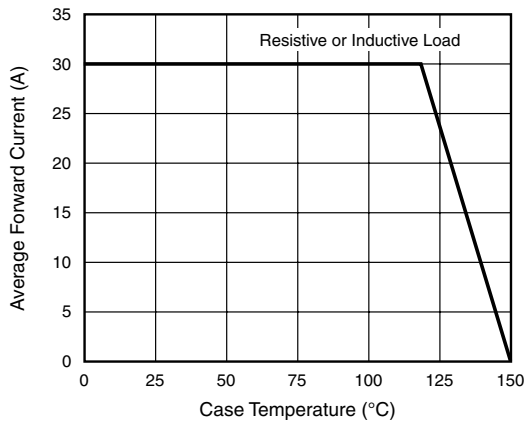

Figure 1. Forward Current Derating Curve

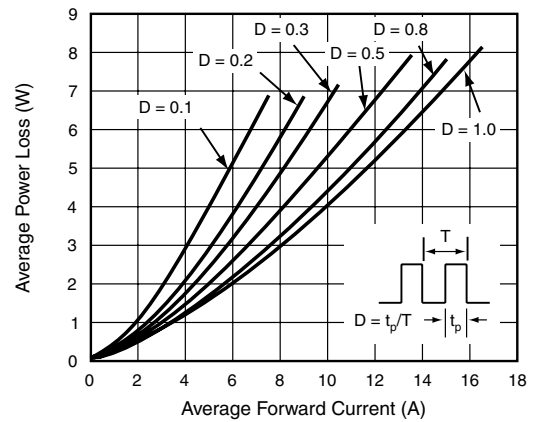

Figure 2. Forward Power Loss Characteristics Per Diode

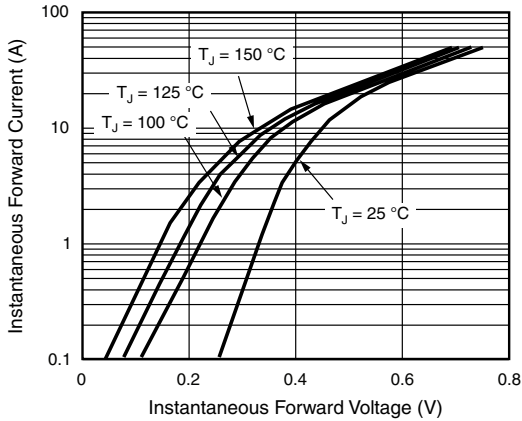

Figure 3. Typical Instantaneous Forward Characteristics Per Diode

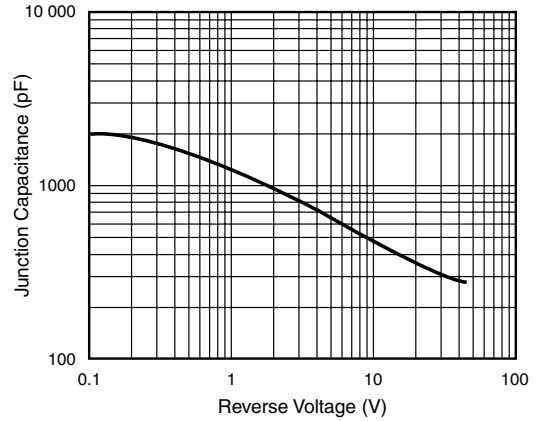

Figure 5. Typical Junction Capacitance Per Diode

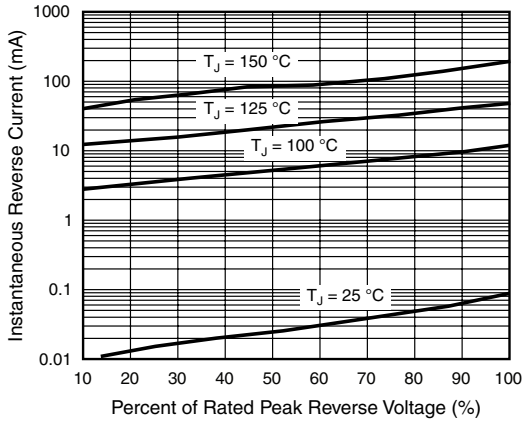

Figure 4. Typical Reverse Characteristics Per Diode

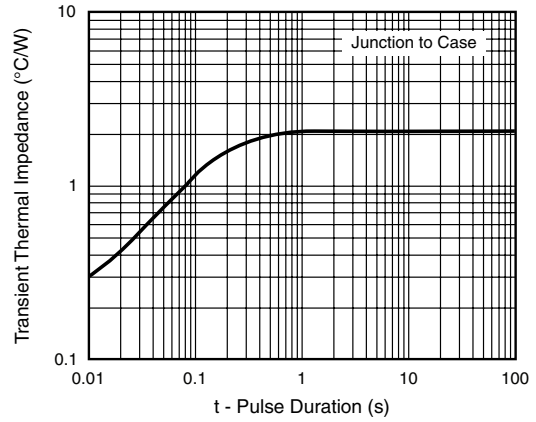
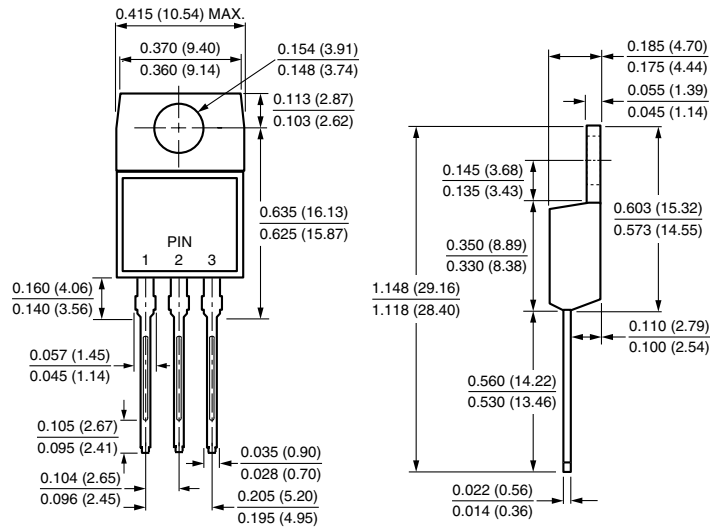

Figure 6. Typical Transient Thermal Impedance Per Diode

**PACKAGE OUTLINE DIMENSIONS** in inches (millimeters)

**TO-220AB**





## Disclaimer

All product specifications and data are subject to change without notice.

Vishay Intertechnology, Inc., its affiliates, agents, and employees, and all persons acting on its or their behalf (collectively, "Vishay"), disclaim any and all liability for any errors, inaccuracies or incompleteness contained herein or in any other disclosure relating to any product.

Vishay disclaims any and all liability arising out of the use or application of any product described herein or of any information provided herein to the maximum extent permitted by law. The product specifications do not expand or otherwise modify Vishay's terms and conditions of purchase, including but not limited to the warranty expressed therein, which apply to these products.

No license, express or implied, by estoppel or otherwise, to any intellectual property rights is granted by this document or by any conduct of Vishay.

The products shown herein are not designed for use in medical, life-saving, or life-sustaining applications unless otherwise expressly indicated. Customers using or selling Vishay products not expressly indicated for use in such applications do so entirely at their own risk and agree to fully indemnify Vishay for any damages arising or resulting from such use or sale. Please contact authorized Vishay personnel to obtain written terms and conditions regarding products designed for such applications.

Product names and markings noted herein may be trademarks of their respective owners.