



2SB649/A

PNP SILICON TRANSISTOR

BIPOLAR POWER GENERAL PURPOSE TRANSISTOR

■ APPLICATIONS

* Low frequency power amplifier complementary pair with UTC 2SD669/A

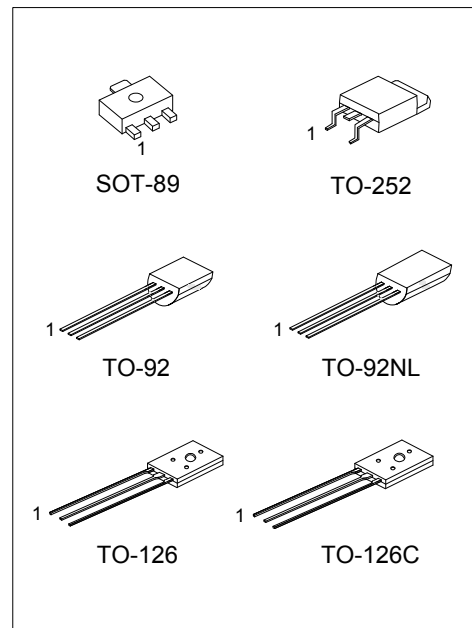

Lead-free: 2SB649L/2SB649AL
Halogen-free: 2SB649G/2SB649AG

■ ORDERING INFORMATION

Ordering Number			Package	Pin Assignment			Packing
Normal	Lead Free	Halogen Free		1	2	3	
2SB649x-x-AB3-R	2SB649xL-x-AB3-R	2SB649xG-x-AB3-R	SOT-89	B	C	E	Tape Reel
2SB649x-x-T6C-K	2SB649xL-x-T6C-K	2SB649xG-x-T6C-K	TO-126C	E	C	B	Bulk
2SB649x-x-T60-K	2SB649xL-x-T60-K	2SB649xG-x-T60-K	TO-126	E	C	B	Bulk
2SB649x-x-T92-B	2SB649xL-x-T92-B	2SB649xG-x-T92-B	TO-92	E	C	B	Tape Box
2SB649x-x-T92-K	2SB649xL-x-T92-K	2SB649xG-x-T92-K	TO-92	E	C	B	Bulk
2SB649x-x-T9N-B	2SB649xL-x-T9N-B	2SB649xG-x-T9N-B	TO-92NL	E	C	B	Tape Box
2SB649x-x-T9N-K	2SB649xL-x-T9N-K	2SB649xG-x-T9N-K	TO-92NL	E	C	B	Bulk
2SB649x-x-TN3-R	2SB649xL-x-TN3-R	2SB649xG-x-TN3-R	TO-252	B	C	E	Tape Reel

<p>2SB649xL-x-AB3-R</p>	<p>(1) B: Tape Box, K: Bulk, R: Tape Reel (2) AB3: SOT-89, T6C: TO-126C, T60: TO-126, T92: TO-92, T9N: TO-92NL, TN3: TO-252 (3) x: refer to Classification of h_{FE1} (4) G: Halogen Free, L: Lead Free, Blank: Pb/Sn (5) A: -160V, Blank: -120V</p>
-------------------------	---

■ ABSOLUTE MAXIMUM RATINGS (Ta=25°C, unless otherwise specified)

PARAMETER		SYMBOL	RATING	UNIT
Collector-Base Voltage		V_{CBO}	-180	V
Collector-Emitter Voltage	2SB649	V_{CEO}	-120	V
	2SB649A		-160	V
Emitter-Base Voltage		V_{EBO}	-5	V
Collector Current		I_C	-1.5	A
Collector Peak Current		$I_{C(PK)}$	-3	A
Collector Power Dissipation	TO-126/TO-126C	P_C	1	W
	TO-92/TO-92NL		0.6	W
	SOT-89		0.5	W
	TO-252		2	W
Junction Temperature		T_J	+150	°C
Storage Temperature		T_{STG}	-40 ~ +150	°C

Note: Absolute maximum ratings are those values beyond which the device could be permanently damaged. Absolute maximum ratings are stress ratings only and functional device operation is not implied.

■ ELECTRICAL CHARACTERISTICS (Ta=25°C, unless otherwise specified)

PARAMETER		SYMBOL	TEST CONDITIONS	MIN	TYP	MAX	UNIT
Collector to Base Breakdown Voltage		BV_{CBO}	$I_C=-1mA, I_E=0$	-180			V
Collector to Emitter Breakdown Voltage	2SB649	BV_{CEO}	$I_C=-10mA, R_{BE}=\infty$	-120			V
	2SB649A			-160			V
Emitter to Base Breakdown Voltage		BV_{EBO}	$I_E=-1mA, I_C=0$	-5			V
Collector Cut-off Current		I_{CBO}	$V_{CB}=-160V, I_E=0$			-10	μA
DC Current Gain	2SB649	h_{FE1}	$V_{CE}=-5V, I_C=-150mA$ (note)	60		320	
		h_{FE2}	$V_{CE}=-5V, I_C=-500mA$ (note)	30			
	2SB649A	h_{FE1}	$V_{CE}=-5V, I_C=-150mA$ (note)	60		200	
		h_{FE2}	$V_{CE}=-5V, I_C=-500mA$ (note)	30			
Collector-Emitter Saturation Voltage		$V_{CE(SAT)}$	$I_C=-600mA, I_B=-50mA$			-1	V
Base-Emitter Voltage		V_{BE}	$V_{CE}=-5V, I_C=-150mA$			-1.5	V
Current Gain Bandwidth Product		f_T	$V_{CE}=-5V, I_C=-150mA$		140		MHz
Output Capacitance		C_{ob}	$V_{CB}=-10V, I_E=0, f=1MHz$		27		pF

Note: Pulse test.

■ CLASSIFICATION OF h_{FE1}

RANGE	RANK		
	B	C	D
2SB649	60-120	100-200	160-320
2SB649A	60-120	100-200	-

TYPICAL CHARACTERISTICS

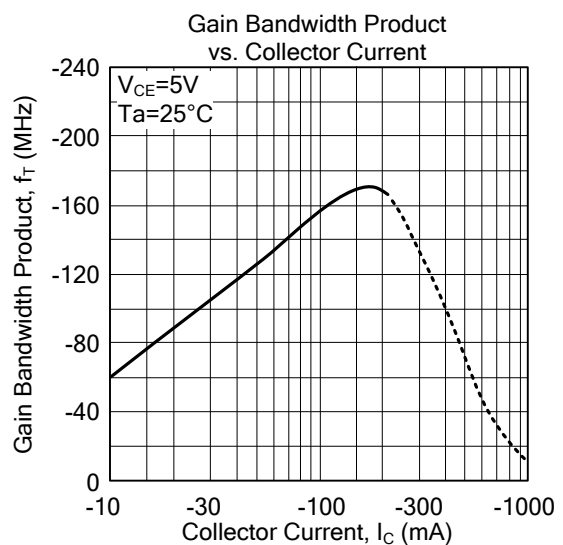
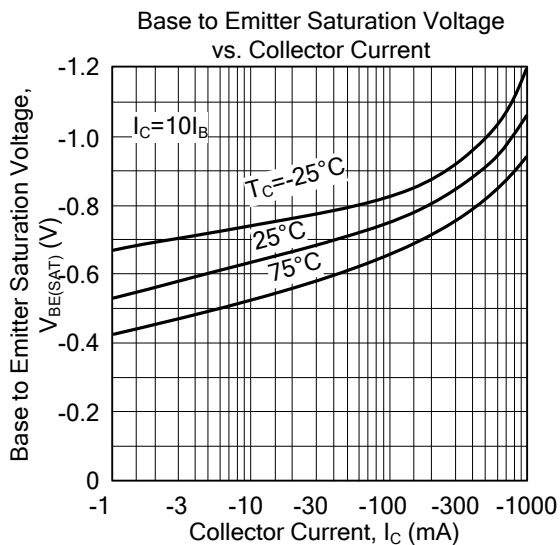
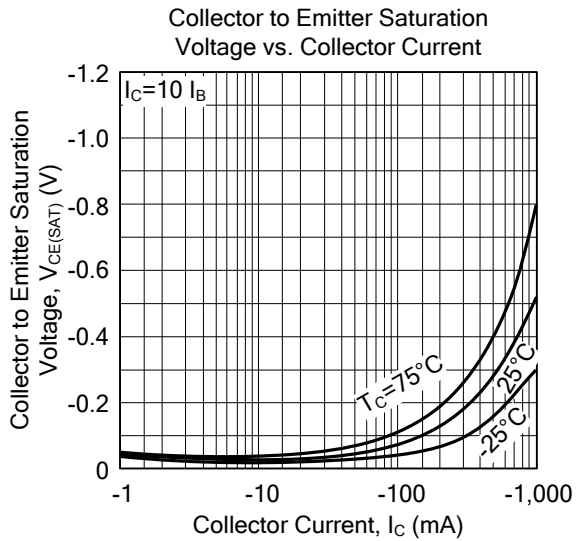
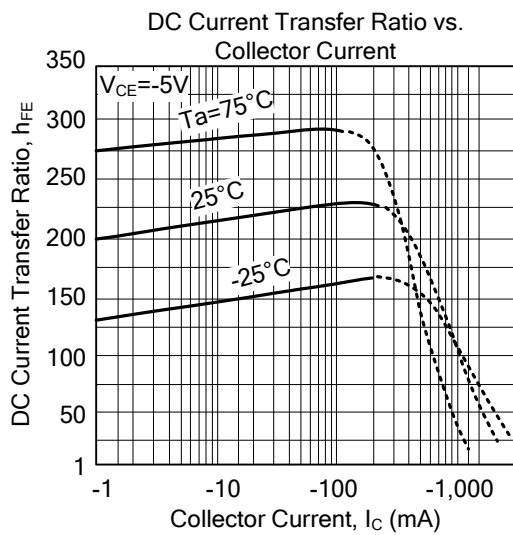
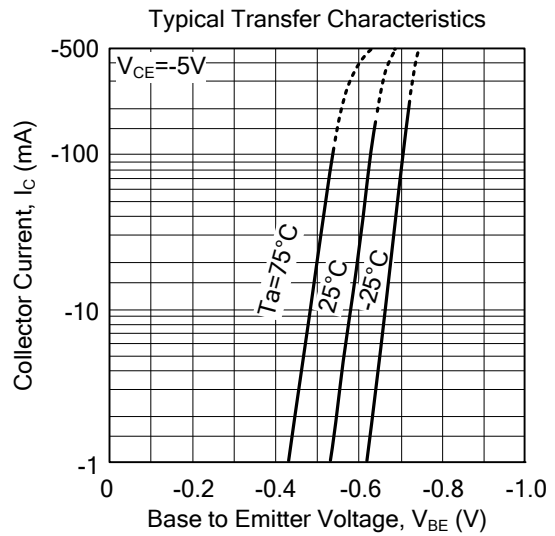
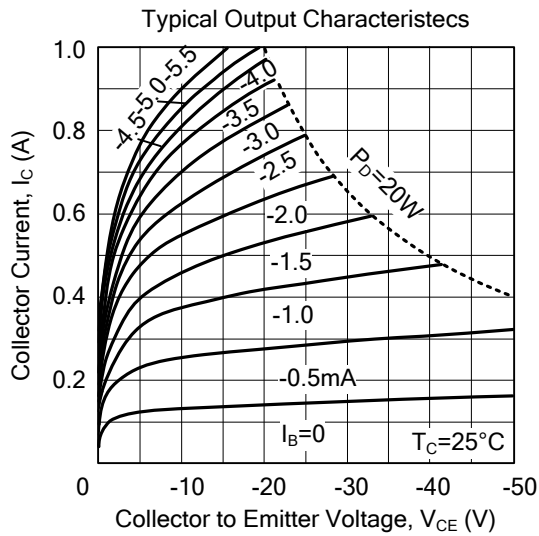

■ TYPICAL CHARACTERISTICS(Cont.)

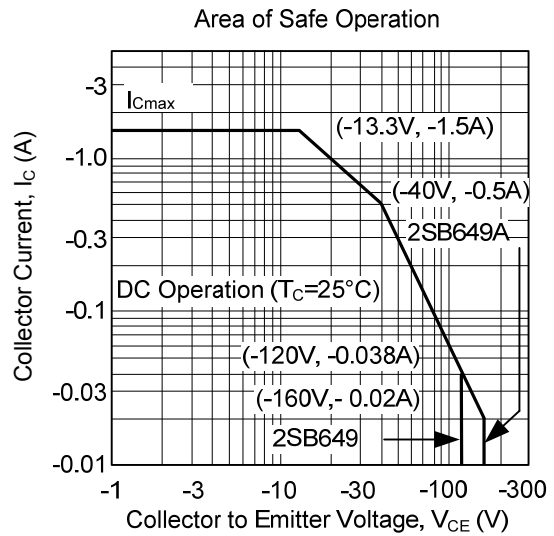
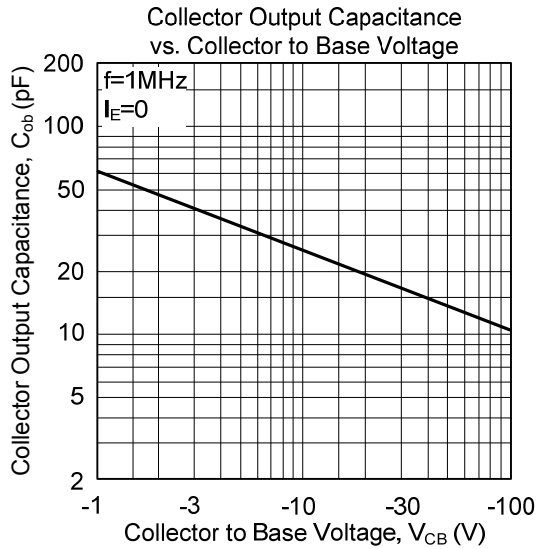

UTC assumes no responsibility for equipment failures that result from using products at values that exceed, even momentarily, rated values (such as maximum ratings, operating condition ranges, or other parameters) listed in products specifications of any and all UTC products described or contained herein. UTC products are not designed for use in life support appliances, devices or systems where malfunction of these products can be reasonably expected to result in personal injury. Reproduction in whole or in part is prohibited without the prior written consent of the copyright owner. The information presented in this document does not form part of any quotation or contract, is believed to be accurate and reliable and may be changed without notice.