

TOSHIBA CMOS Digital Integrated Circuit Silicon Monolithic

## TC7MP97FT, TC7MP97FK TC7MP98FT, TC7MP98FK

### Low Voltage Triple Configurable Multiple Function Gate with 3.6 V Tolerant Inputs and Outputs

The TC7MP97,98 is a high performance CMOS multiple Function Gate which is guaranteed to operate from 1.2-V to 3.6-V. Designed for use in 1.5 V, 1.8 V, 2.5 V or 3.3 V systems, it achieves high speed operation while maintaining the CMOS low power dissipation.

It is also designed with over voltage tolerant inputs and outputs up to 3.6 V.

It independently consists of three circuits for Multiple Function Gate.

The output state is determined by seven patterns of 3-inputs.

The user can choose the functions of Multiplexer, AND, OR, NAND, Schmitt Inverter, and Schmitt Buffer.

All inputs are equipped with protection circuits against static discharge.

### Features

- Low-voltage operation :  $V_{CC} = 1.2$  to  $3.6$  V
- High-speed operation :  $t_{pd} = 8.5$  ns (max) ( $V_{CC} = 3.0$  to  $3.6$  V)  
:  $t_{pd} = 12.0$  ns (max) ( $V_{CC} = 2.3$  to  $2.7$  V)
- Output current :  $|I_{OH}|/I_{OL} = \pm 8$  mA (min) ( $V_{CC} = 3.0$  V)  
:  $|I_{OH}|/I_{OL} = \pm 4$  mA (min) ( $V_{CC} = 2.3$  V)  
:  $|I_{OH}|/I_{OL} = \pm 1.5$  mA (min) ( $V_{CC} = 1.65$  V)
- Latch-up performance :  $-300$  mA
- ESD performance : Machine model  $\geq \pm 200$  V  
Human body model  $\geq \pm 2000$  V
- Package : VSSOP14 (US14), TSSOP14
- Power-down protection is provided on all inputs and outputs

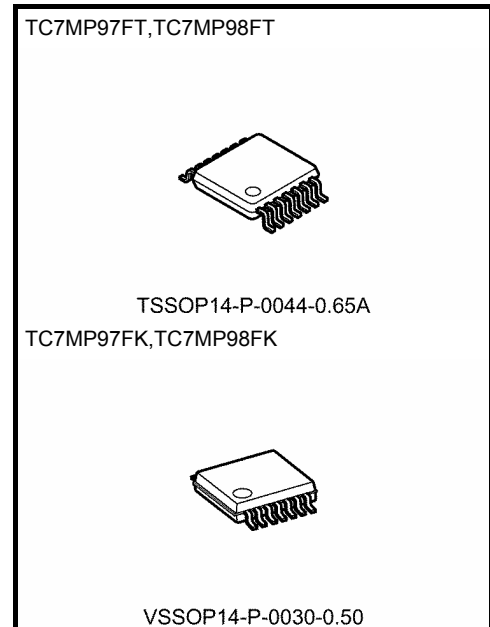

Weight:

TSSOP14-P-0044-0.65A : 0.06 g(typ)

VSSOP14-P-0030-0.50 : 0.02 g(typ)

## Pin Assignment (top view)

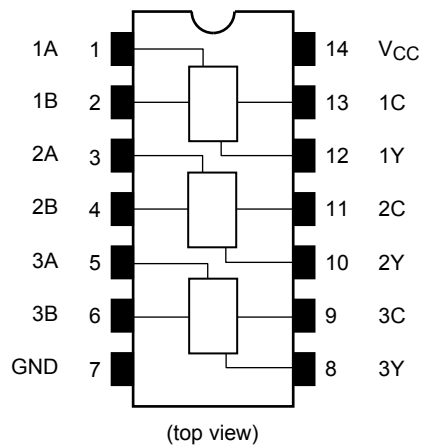

## Truth Table

INPUTS			OUTPUT	
			TC7MP97	TC7MP98
A	B	C	Y	Y
L	L	L	L	H
L	L	H	L	H
L	H	L	H	L
L	H	H	L	H
H	L	L	L	H
H	L	H	H	L
H	H	L	H	L
H	H	H	H	L

## System Diagram

TC7MP97

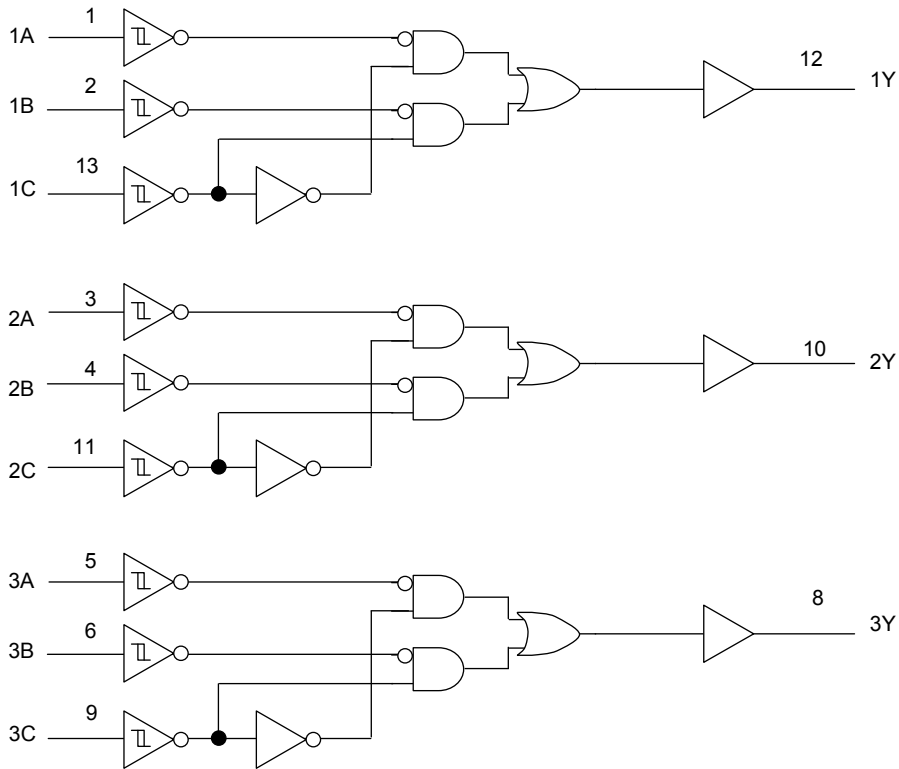



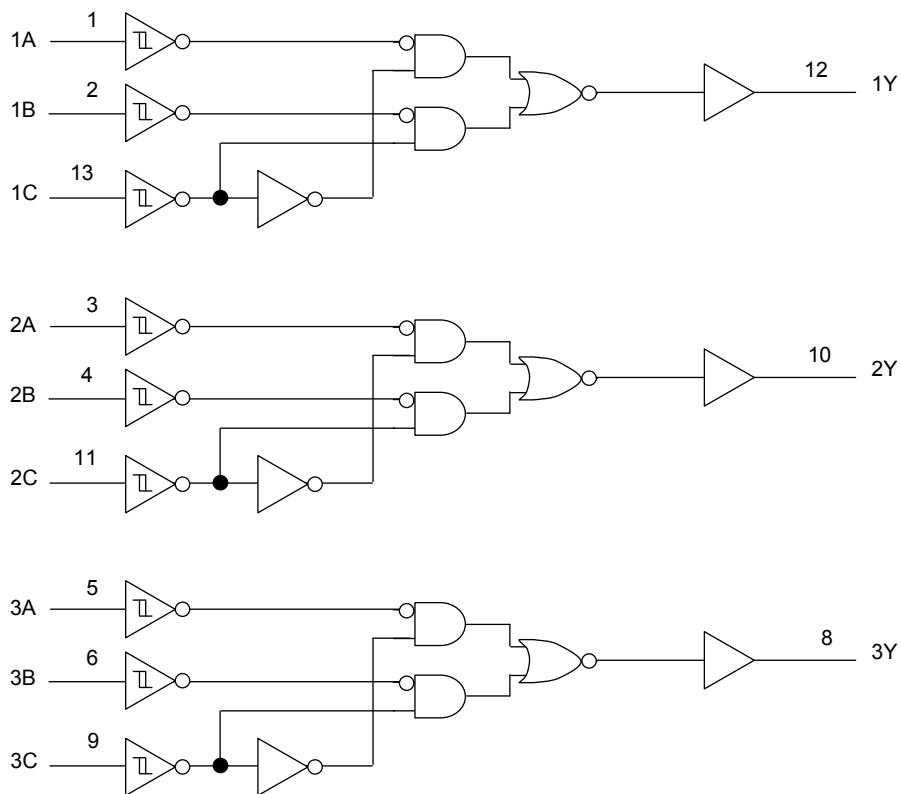

TC7MP98

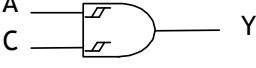
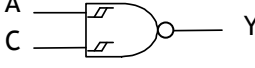
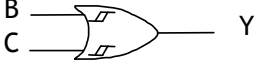
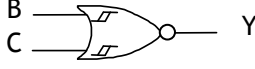
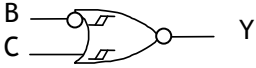
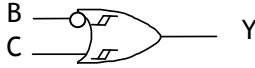
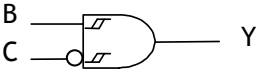
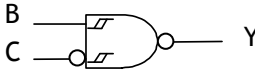
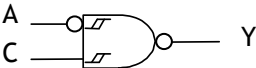
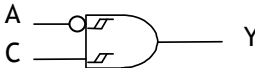
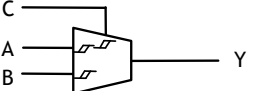
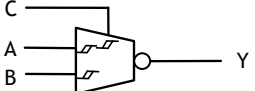

## Logic configurations(1/2)

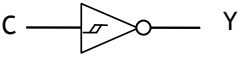
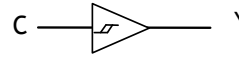
Function	Input Condition	TC7MP97 Logic symbol	TC7MP98 Logic symbol	FUNCTION TABLE																																															
MP97 AND	A=INPUT B=L-Level C=INPUT Y=OUTPUT			<table border="1"> <thead> <tr> <th rowspan="2">A</th> <th rowspan="2">B</th> <th rowspan="2">C</th> <th colspan="2">Y</th> </tr> <tr> <th>97</th> <th>98</th> </tr> </thead> <tbody> <tr> <td>L</td> <td>L</td> <td>L</td> <td>L</td> <td>H</td> </tr> <tr> <td>L</td> <td>L</td> <td>H</td> <td>L</td> <td>H</td> </tr> <tr> <td>H</td> <td>L</td> <td>L</td> <td>L</td> <td>H</td> </tr> <tr> <td>H</td> <td>L</td> <td>H</td> <td>H</td> <td>L</td> </tr> </tbody> </table>	A	B	C	Y		97	98	L	L	L	L	H	L	L	H	L	H	H	L	L	L	H	H	L	H	H	L																				
A				B				C	Y																																										
	97	98																																																	
L	L	L	L	H																																															
L	L	H	L	H																																															
H	L	L	L	H																																															
H	L	H	H	L																																															
MP98 NAND	MP97 OR			<table border="1"> <thead> <tr> <th rowspan="2">A</th> <th rowspan="2">B</th> <th rowspan="2">C</th> <th colspan="2">Y</th> </tr> <tr> <th>97</th> <th>98</th> </tr> </thead> <tbody> <tr> <td>H</td> <td>L</td> <td>L</td> <td>L</td> <td>H</td> </tr> <tr> <td>H</td> <td>L</td> <td>H</td> <td>H</td> <td>L</td> </tr> <tr> <td>H</td> <td>H</td> <td>L</td> <td>H</td> <td>L</td> </tr> <tr> <td>H</td> <td>H</td> <td>H</td> <td>H</td> <td>L</td> </tr> </tbody> </table>	A	B	C	Y		97	98	H	L	L	L	H	H	L	H	H	L	H	H	L	H	L	H	H	H	H	L																				
A	B			C				Y																																											
		97	98																																																
H	L	L	L	H																																															
H	L	H	H	L																																															
H	H	L	H	L																																															
H	H	H	H	L																																															
MP98 NOR	A=L-Level B=INPUT C=INPUT Y=OUTPUT			<table border="1"> <thead> <tr> <th rowspan="2">A</th> <th rowspan="2">B</th> <th rowspan="2">C</th> <th colspan="2">Y</th> </tr> <tr> <th>97</th> <th>98</th> </tr> </thead> <tbody> <tr> <td>L</td> <td>L</td> <td>L</td> <td>L</td> <td>H</td> </tr> <tr> <td>L</td> <td>L</td> <td>H</td> <td>L</td> <td>H</td> </tr> <tr> <td>L</td> <td>H</td> <td>L</td> <td>H</td> <td>L</td> </tr> <tr> <td>L</td> <td>H</td> <td>H</td> <td>L</td> <td>H</td> </tr> </tbody> </table>	A	B	C	Y		97	98	L	L	L	L	H	L	L	H	L	H	L	H	L	H	L	L	H	H	L	H																				
A								B	C	Y																																									
	97	98																																																	
L	L	L	L	H																																															
L	L	H	L	H																																															
L	H	L	H	L																																															
L	H	H	L	H																																															
MP97 Schmitt INV+NOR or Schmitt INV+AND	A=L-Level B=INPUT C=INPUT Y=OUTPUT			<table border="1"> <thead> <tr> <th rowspan="2">A</th> <th rowspan="2">B</th> <th rowspan="2">C</th> <th colspan="2">Y</th> </tr> <tr> <th>97</th> <th>98</th> </tr> </thead> <tbody> <tr> <td>L</td> <td>H</td> <td>L</td> <td>H</td> <td>L</td> </tr> <tr> <td>L</td> <td>H</td> <td>H</td> <td>L</td> <td>H</td> </tr> <tr> <td>H</td> <td>H</td> <td>L</td> <td>H</td> <td>L</td> </tr> <tr> <td>H</td> <td>H</td> <td>H</td> <td>H</td> <td>L</td> </tr> </tbody> </table>	A	B	C	Y		97	98	L	H	L	H	L	L	H	H	L	H	H	H	L	H	L	H	H	H	H	L																				
A								B	C	Y																																									
	97	98																																																	
L	H	L	H	L																																															
L	H	H	L	H																																															
H	H	L	H	L																																															
H	H	H	H	L																																															
MP98 Schmitt INV+OR or Schmitt INV+NAND	A=INPUT B=L-Level C=INPUT Y=OUTPUT			<table border="1"> <thead> <tr> <th rowspan="2">A</th> <th rowspan="2">B</th> <th rowspan="2">C</th> <th colspan="2">Y</th> </tr> <tr> <th>97</th> <th>98</th> </tr> </thead> <tbody> <tr> <td>L</td> <td>H</td> <td>L</td> <td>H</td> <td>L</td> </tr> <tr> <td>L</td> <td>H</td> <td>H</td> <td>L</td> <td>H</td> </tr> <tr> <td>H</td> <td>H</td> <td>L</td> <td>H</td> <td>L</td> </tr> <tr> <td>H</td> <td>H</td> <td>H</td> <td>H</td> <td>L</td> </tr> </tbody> </table>	A	B	C	Y		97	98	L	H	L	H	L	L	H	H	L	H	H	H	L	H	L	H	H	H	H	L																				
A								B	C	Y																																									
	97	98																																																	
L	H	L	H	L																																															
L	H	H	L	H																																															
H	H	L	H	L																																															
H	H	H	H	L																																															
MP97 Schmitt INV+NAND or Schmitt INV+OR	A=INPUT B=INPUT C=Select Y=OUTPUT			<table border="1"> <thead> <tr> <th rowspan="2">A</th> <th rowspan="2">B</th> <th rowspan="2">C</th> <th colspan="2">Y</th> </tr> <tr> <th>97</th> <th>98</th> </tr> </thead> <tbody> <tr> <td>L</td> <td>L</td> <td>L</td> <td>L</td> <td>H</td> </tr> <tr> <td>L</td> <td>H</td> <td>L</td> <td>H</td> <td>L</td> </tr> <tr> <td>H</td> <td>L</td> <td>L</td> <td>L</td> <td>H</td> </tr> <tr> <td>H</td> <td>H</td> <td>L</td> <td>H</td> <td>L</td> </tr> <tr> <td>L</td> <td>L</td> <td>H</td> <td>L</td> <td>H</td> </tr> <tr> <td>L</td> <td>H</td> <td>H</td> <td>L</td> <td>H</td> </tr> <tr> <td>H</td> <td>L</td> <td>H</td> <td>H</td> <td>L</td> </tr> <tr> <td>H</td> <td>H</td> <td>H</td> <td>H</td> <td>L</td> </tr> </tbody> </table>	A	B	C	Y		97	98	L	L	L	L	H	L	H	L	H	L	H	L	L	L	H	H	H	L	H	L	L	L	H	L	H	L	H	H	L	H	H	L	H	H	L	H	H	H	H	L
A								B	C	Y																																									
	97	98																																																	
L	L	L	L	H																																															
L	H	L	H	L																																															
H	L	L	L	H																																															
H	H	L	H	L																																															
L	L	H	L	H																																															
L	H	H	L	H																																															
H	L	H	H	L																																															
H	H	H	H	L																																															
MP98 2 to 1 Selector+INV																																																			

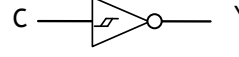
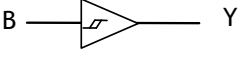
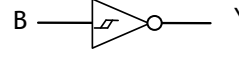
## Logic configurations(2/2)

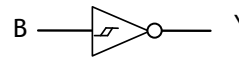
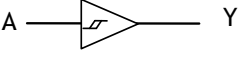
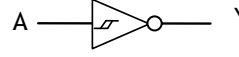
Function	Input Condition	TC7MP97 Logic symbol	TC7MP98 Logic symbol	FUNCTION TABLE																	
MP97 Schmitt INV	A=L-Level B=H-Level C=INPUT Y=OUTPUT			<table border="1"> <thead> <tr> <th rowspan="2">A</th> <th rowspan="2">B</th> <th rowspan="2">C</th> <th colspan="2">Y</th> </tr> <tr> <th>97</th> <th>98</th> </tr> </thead> <tbody> <tr> <td>L</td> <td>H</td> <td>L</td> <td>H</td> <td>L</td> </tr> <tr> <td>L</td> <td>H</td> <td>H</td> <td>L</td> <td>H</td> </tr> </tbody> </table>	A	B	C	Y		97	98	L	H	L	H	L	L	H	H	L	H
A	B	C	Y																		
			97	98																	
L	H	L	H	L																	
L	H	H	L	H																	
MP98 Schmitt Buffer																					
MP97 Schmitt Buffer	A=H-Level B=L-Level C=INPUT Y=OUTPUT			<table border="1"> <thead> <tr> <th rowspan="2">A</th> <th rowspan="2">B</th> <th rowspan="2">C</th> <th colspan="2">Y</th> </tr> <tr> <th>97</th> <th>98</th> </tr> </thead> <tbody> <tr> <td>H</td> <td>L</td> <td>L</td> <td>L</td> <td>H</td> </tr> <tr> <td>H</td> <td>L</td> <td>H</td> <td>H</td> <td>L</td> </tr> </tbody> </table>	A	B	C	Y		97	98	H	L	L	L	H	H	L	H	H	L
A	B	C	Y																		
			97	98																	
H	L	L	L	H																	
H	L	H	H	L																	
MP98 Schmitt INV																					
MP97 Schmitt Buffer	A=L-Level B=INPUT C=L-Level Y=OUTPUT			<table border="1"> <thead> <tr> <th rowspan="2">A</th> <th rowspan="2">B</th> <th rowspan="2">C</th> <th colspan="2">Y</th> </tr> <tr> <th>97</th> <th>98</th> </tr> </thead> <tbody> <tr> <td>L</td> <td>L</td> <td>L</td> <td>L</td> <td>H</td> </tr> <tr> <td>L</td> <td>H</td> <td>L</td> <td>H</td> <td>L</td> </tr> </tbody> </table>	A	B	C	Y		97	98	L	L	L	L	H	L	H	L	H	L
A	B	C	Y																		
			97	98																	
L	L	L	L	H																	
L	H	L	H	L																	
MP98 Schmitt INV																					
MP97 Schmitt Buffer	A=H-Level B=INPUT C=L-Level Y=OUTPUT			<table border="1"> <thead> <tr> <th rowspan="2">A</th> <th rowspan="2">B</th> <th rowspan="2">C</th> <th colspan="2">Y</th> </tr> <tr> <th>97</th> <th>98</th> </tr> </thead> <tbody> <tr> <td>H</td> <td>L</td> <td>L</td> <td>L</td> <td>H</td> </tr> <tr> <td>H</td> <td>H</td> <td>L</td> <td>H</td> <td>L</td> </tr> </tbody> </table>	A	B	C	Y		97	98	H	L	L	L	H	H	H	L	H	L
A	B	C	Y																		
			97	98																	
H	L	L	L	H																	
H	H	L	H	L																	
MP98 Schmitt INV																					
MP97 Schmitt Buffer	A=INPUT B=L-Level C=H-Level Y=OUTPUT			<table border="1"> <thead> <tr> <th rowspan="2">A</th> <th rowspan="2">B</th> <th rowspan="2">C</th> <th colspan="2">Y</th> </tr> <tr> <th>97</th> <th>98</th> </tr> </thead> <tbody> <tr> <td>L</td> <td>L</td> <td>H</td> <td>L</td> <td>H</td> </tr> <tr> <td>H</td> <td>L</td> <td>H</td> <td>H</td> <td>L</td> </tr> </tbody> </table>	A	B	C	Y		97	98	L	L	H	L	H	H	L	H	H	L
A	B	C	Y																		
			97	98																	
L	L	H	L	H																	
H	L	H	H	L																	
MP98 Schmitt INV																					

## Absolute Maximum Ratings (Note 1)

Characteristics	Symbol	Rating	Unit
Power supply voltage	$V_{CC}$	-0.5 to 4.6	V
DC input voltage	$V_{IN}$	-0.5 to 4.6	V
DC output voltage	$V_{OUT}$	-0.5 to 4.6 (Note 2)	V
		-0.5 to $V_{CC} + 0.5$ (Note 3)	
Input diode current	$I_{IK}$	-20	mA
Output diode current	$I_{OK}$	$\pm 20$ (Note 4)	mA
DC output current	$I_{OUT}$	$\pm 25$	mA
Power dissipation	$P_D$	180	mW
DC $V_{CC}$ /ground current	$I_{CC}/I_{GND}$	$\pm 25$	mA
Storage temperature	$T_{stg}$	-65~150	$^{\circ}C$

Note 1: Exceeding any of the absolute maximum ratings, even briefly, lead to deterioration in IC performance or even destruction.

Using continuously under heavy loads (e.g. the application of high temperature/current/voltage and the significant change in temperature, etc.) may cause this product to decrease in the reliability significantly even if the operating conditions (i.e. operating temperature/current/voltage, etc.) are within the absolute maximum ratings and the operating ranges.

Please design the appropriate reliability upon reviewing the Toshiba Semiconductor Reliability Handbook ("Handling Precautions"/"Derating Concept and Methods") and individual reliability data (i.e. reliability test report and estimated failure rate, etc).

Note 2:  $V_{CC} = 0$  V

Note 3: High or Low state.  $I_{OUT}$  absolute rating must be observed.

Note 4:  $V_{OUT} < GND$ ,  $V_{OUT} > V_{CC}$

## Operating Ranges (Note 1)

Characteristics	Symbol	Rating	Unit
Supply voltage	$V_{CC}$	1.2~3.6	V
Input voltage	$V_{IN}$	-0.3~3.6	V
Output voltage	$V_{OUT}$	0~3.6 (Note 2)	V
		0~ $V_{CC}$ (Note 3)	
Output current	$I_{OH}/I_{OL}$	$\pm 8.0$ (Note 4)	mA
		$\pm 4.0$ (Note 5)	
		$\pm 1.5$ (Note 6)	
Operating temperature	$T_{opr}$	-40~85	$^{\circ}C$

Note 1: The operating ranges must be maintained to ensure the normal operation of the device. Unused inputs must be tied to either  $V_{CC}$  or GND.

Note 2:  $V_{CC} = 0$  V

Note 3: High or low state

Note 4:  $V_{CC} = 3.0\sim 3.6$  V

Note 5:  $V_{CC} = 2.3\sim 2.7$  V

Note 6:  $V_{CC} = 1.65\sim 1.8$  V

## Electrical Characteristics

### DC Characteristics (Ta = -40 to 85°C)

Characteristics		Symbol	Test Condition	V <sub>CC</sub> (V)	Min	Max	Unit	
Input voltage	H-level	V <sub>P</sub>	—	1.2		1.10	V	
				1.4		1.20		
				1.65		1.35		
				2.3		1.70		
				3.0		2.00		
				3.6		2.20		
	L-level	V <sub>N</sub>	—	1.2	0.10		V	
				1.4	0.20			
				1.65	0.30			
				2.3	0.50			
				3.0	0.70			
				3.6	0.80			
Hysteresis voltage		V <sub>H</sub>	—	1.2	0.2	0.9	V	
				1.4	0.2	0.9		
				1.65	0.2	0.95		
				2.3	0.3	1.0		
				3.0	0.3	1.2		
				3.6	0.3	1.2		
Output voltage	H-level	V <sub>OH</sub>	V <sub>IN</sub> = V <sub>IH</sub> or V <sub>IL</sub>	I <sub>OH</sub> = -100 μA	1.2~1.3	V <sub>CC</sub> - 0.1	—	V
				I <sub>OH</sub> = -500 μA	1.4~1.6	V <sub>CC</sub> - 0.2	—	
				I <sub>OH</sub> = -1.5 mA	1.65~1.95	V <sub>CC</sub> - 0.3	—	
				I <sub>OH</sub> = -4.0 mA	2.3~2.7	V <sub>CC</sub> - 0.4	—	
				I <sub>OH</sub> = -8.0 mA	3.0~3.6	2.40	—	
	L-level	V <sub>OL</sub>	V <sub>IN</sub> = V <sub>IH</sub> or V <sub>IL</sub>	I <sub>OL</sub> = 100 μA	1.2~1.3	—	0.10	
				I <sub>OL</sub> = 500 μA	1.4~1.6	—	0.20	
				I <sub>OL</sub> = 3.0 mA	1.65~1.95	—	0.25	
				I <sub>OL</sub> = 4.0 mA	2.3~2.7	—	0.40	
				I <sub>OL</sub> = 8.0 mA	3.0~3.6	—	0.40	
Input leakage current		I <sub>IN</sub>	V <sub>IN</sub> = 0~3.6 V	1.2~3.6	—	±5.0	μA	
Power-off leakage current		I <sub>OFF</sub>	V <sub>IN</sub> , V <sub>OUT</sub> = 0~3.6 V	0	—	10.0	μA	
Quiescent supply current		I <sub>CC</sub>	V <sub>IN</sub> = V <sub>CC</sub> or GND	1.2~3.6	—	20.0	μA	
			V <sub>CC</sub> ≤ V <sub>IN</sub> ≤ 3.6 V	1.2~3.6	—	±20.0		
Increase in I <sub>CC</sub> per input		ΔI <sub>CC</sub>	V <sub>IH</sub> = V <sub>CC</sub> - 0.6 V	2.7~3.6	—	750		

## AC Characteristics (Ta = -40 to 85°C, input: tr = tf = 3.0 ns)

Characteristics	Symbol	Test Condition	VCC (V)	Min	Max	Unit
Propagation delay time (A, B, C-Y)	t <sub>pLH</sub> t <sub>pHL</sub>	Figure 1, Figure 2 CL = 10pF, RL = 1M Ω	1.8 ± 0.15	1.0	21.0	ns
			2.5 ± 0.2	0.8	10.0	
			3.3 ± 0.3	0.6	7.0	
	t <sub>pLH</sub> t <sub>pHL</sub>	Figure 1, Figure 2 CL = 15pF, RL = 1M Ω	1.8 ± 0.15	1.0	23.0	ns
			2.5 ± 0.2	0.8	11.0	
			3.3 ± 0.3	0.6	7.7	
	t <sub>pLH</sub> t <sub>pHL</sub>	Figure 1, Figure 2 CL = 30pF, RL = 1M Ω	1.8 ± 0.15	1.0	27.0	ns
			2.5 ± 0.2	0.8	12.0	
			3.3 ± 0.3	0.6	8.5	

## Dynamic Switching Characteristics (Ta = 25°C, input: tr = tf = 3.0 ns, CL = 30 pF)

Characteristics	Symbol	Test Condition	VCC (V)	Typ.	Unit
Quiet output maximum dynamic VOL	VOLP	V <sub>IH</sub> = 1.8 V, V <sub>IL</sub> = 0 V (Note)	1.8	0.25	V
		V <sub>IH</sub> = 2.5 V, V <sub>IL</sub> = 0 V (Note)	2.5	0.6	
		V <sub>IH</sub> = 3.3 V, V <sub>IL</sub> = 0 V (Note)	3.3	0.8	
Quiet output minimum dynamic VOL	VOLV	V <sub>IH</sub> = 1.8 V, V <sub>IL</sub> = 0 V (Note)	1.8	-0.25	V
		V <sub>IH</sub> = 2.5 V, V <sub>IL</sub> = 0 V (Note)	2.5	-0.6	
		V <sub>IH</sub> = 3.3 V, V <sub>IL</sub> = 0 V (Note)	3.3	-0.8	
Quiet output minimum dynamic VOH	VOHV	V <sub>IH</sub> = 1.8 V, V <sub>IL</sub> = 0 V (Note)	1.8	1.5	V
		V <sub>IH</sub> = 2.5 V, V <sub>IL</sub> = 0 V (Note)	2.5	1.9	
		V <sub>IH</sub> = 3.3 V, V <sub>IL</sub> = 0 V (Note)	3.3	2.2	

Note: Parameter guaranteed by design.

## Capacitive Characteristics (Ta = 25°C)

Characteristics	Symbol	Test Condition	VCC (V)	Typ.	Unit
Input capacitance	C <sub>IN</sub>	—	1.8, 2.5, 3.3	6	pF
Power dissipation capacitance	C <sub>PD</sub>	f <sub>IN</sub> = 10 MHz (Note)	1.8, 2.5, 3.3	30	pF

Note: C<sub>PD</sub> is defined as the value of the internal equivalent capacitance which is calculated from the operating current consumption without load.

Average operating current can be obtained by the equation:

$$I_{CC (opr)} = C_{PD} \cdot V_{CC} \cdot f_{IN} + I_{CC}$$



**AC Test Circuit**

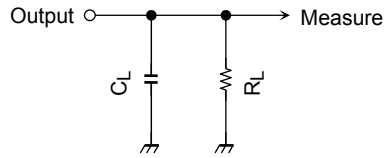

**Figure 1**

**AC Waveform**

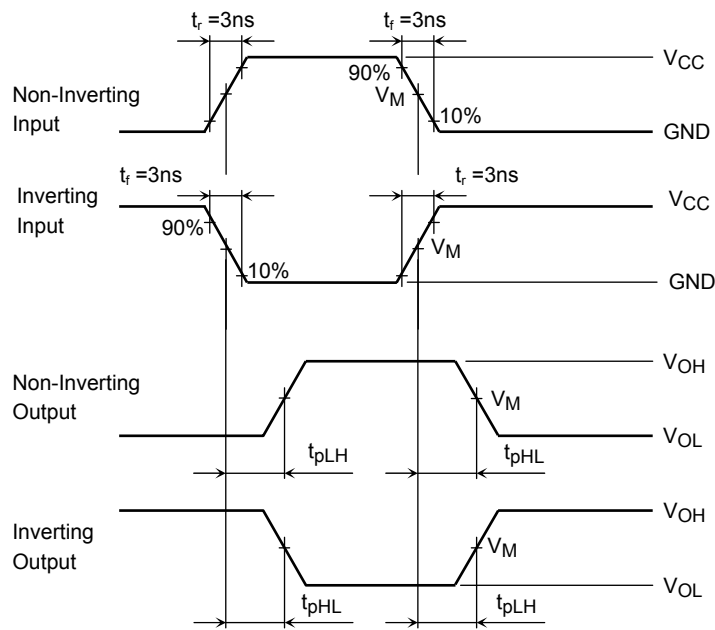

Symbol	V <sub>CC</sub>		
	3.3 ± 0.3 V	2.5 ± 0.2 V	1.8 V ± 0.15 V
V <sub>IN</sub>	V <sub>CC</sub>	V <sub>CC</sub>	V <sub>CC</sub>
V <sub>M</sub>	1.5 V	V <sub>CC</sub> /2	V <sub>CC</sub> /2

**Figure 2 t<sub>pLH</sub>, t<sub>pHL</sub>**

**Package Dimensions**

TSSOP14-P-0044-0.65A

Unit: mm

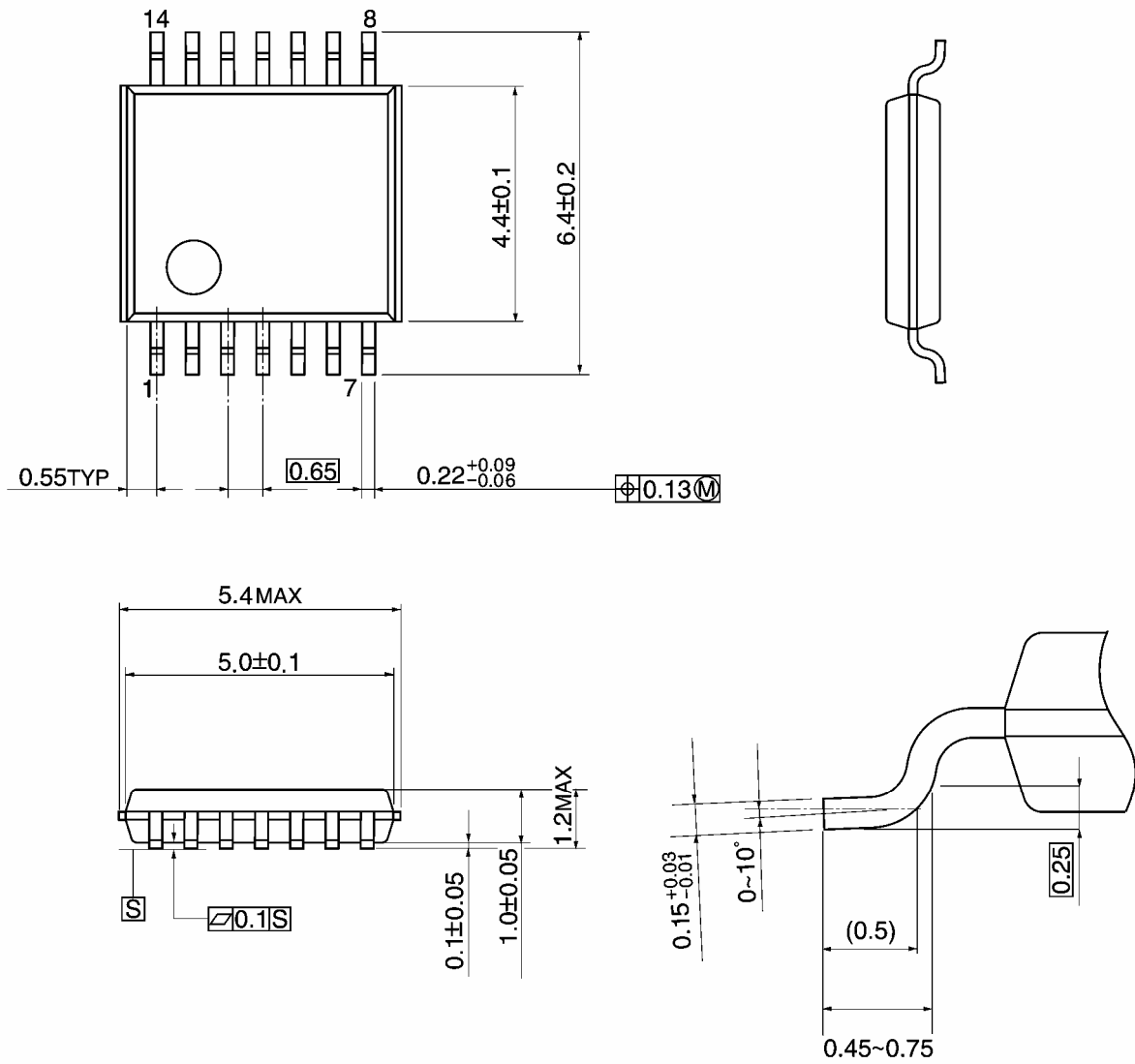

Weight: 0.06 g (typ.)

**Package Dimensions**

VSSOP14-P-0030-0.50

Unit: mm

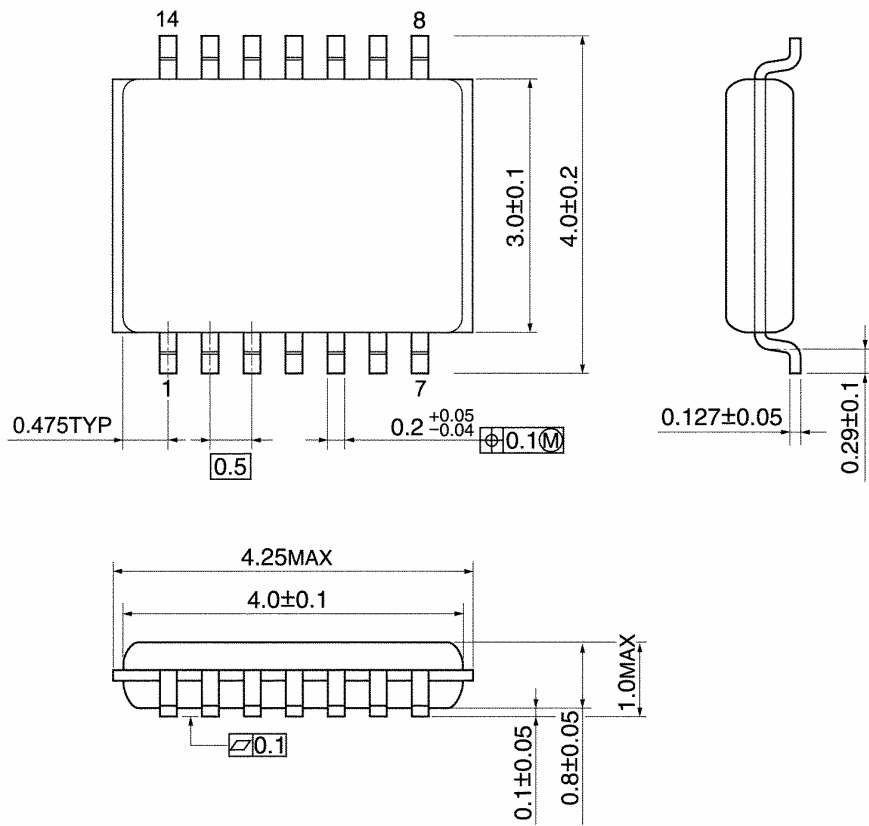

Weight: 0.02 g (typ.)

**RESTRICTIONS ON PRODUCT USE**

20070701-EN GENERAL

- The information contained herein is subject to change without notice.
- TOSHIBA is continually working to improve the quality and reliability of its products. Nevertheless, semiconductor devices in general can malfunction or fail due to their inherent electrical sensitivity and vulnerability to physical stress. It is the responsibility of the buyer, when utilizing TOSHIBA products, to comply with the standards of safety in making a safe design for the entire system, and to avoid situations in which a malfunction or failure of such TOSHIBA products could cause loss of human life, bodily injury or damage to property.  
In developing your designs, please ensure that TOSHIBA products are used within specified operating ranges as set forth in the most recent TOSHIBA products specifications. Also, please keep in mind the precautions and conditions set forth in the "Handling Guide for Semiconductor Devices," or "TOSHIBA Semiconductor Reliability Handbook" etc.
- The TOSHIBA products listed in this document are intended for usage in general electronics applications (computer, personal equipment, office equipment, measuring equipment, industrial robotics, domestic appliances, etc.). These TOSHIBA products are neither intended nor warranted for usage in equipment that requires extraordinarily high quality and/or reliability or a malfunction or failure of which may cause loss of human life or bodily injury ("Unintended Usage"). Unintended Usage include atomic energy control instruments, airplane or spaceship instruments, transportation instruments, traffic signal instruments, combustion control instruments, medical instruments, all types of safety devices, etc.. Unintended Usage of TOSHIBA products listed in this document shall be made at the customer's own risk.
- The products described in this document shall not be used or embedded to any downstream products of which manufacture, use and/or sale are prohibited under any applicable laws and regulations.
- The information contained herein is presented only as a guide for the applications of our products. No responsibility is assumed by TOSHIBA for any infringements of patents or other rights of the third parties which may result from its use. No license is granted by implication or otherwise under any patents or other rights of TOSHIBA or the third parties.
- Please contact your sales representative for product-by-product details in this document regarding RoHS compatibility. Please use these products in this document in compliance with all applicable laws and regulations that regulate the inclusion or use of controlled substances. Toshiba assumes no liability for damage or losses occurring as a result of noncompliance with applicable laws and regulations.