

1A, 40V - 200V Schottky Barrier Surface Mount Rectifier

FEATURES

- Ideal for automated placement
- Compact package size, profile <0.85mm
- Ultra low leakage current
- High surge current capability
- Low power loss, high efficiency
- Moisture sensitivity level: level 1, per J-STD-020
- RoHS Compliant
- Halogen-free according to IEC 61249-2-21

APPLICATIONS

- Switching mode power supply (SMPS)
- Adapters
- DC to DC converter

MECHANICAL DATA

- Case: SOD-123HE
- Molding compound meets UL 94V-0 flammability rating
- Terminal: Matte tin plated leads, solderable per J-STD-002
- Meet JESD 201 class 2 whisker test
- Polarity: Indicated by cathode band
- Weight: 0.021g (approximately)

KEY PARAMETERS		
PARAMETER	VALUE	UNIT
I_F	1	A
V_{RRM}	40 - 200	V
I_{FSM}	30	A
$T_{J\ MAX}$	150	°C
Package	SOD-123HE	
Configuration	Single die	



ABSOLUTE MAXIMUM RATINGS ($T_A = 25^\circ\text{C}$ unless otherwise noted)							
PARAMETER	SYMBOL	SS1H4 LS	SS1H6 LS	SS1H10 LS	SS1H15 LS	SS1H20 LS	UNIT
Marking code on the device		1H4LS	1H6LS	1H10LS	1H15LS	1H20LS	
Repetitive peak reverse voltage	V_{RRM}	40	60	100	150	200	V
Reverse voltage, total rms value	$V_{R(RMS)}$	28	42	70	105	140	V
Forward current	I_F	1					A
Peak forward surge current, 8.3ms single half sine-wave superimposed on rated load	I_{FSM}	30					A
Junction temperature	T_J	- 55 to +150					°C
Storage temperature	T_{STG}	- 55 to +150					°C

THERMAL PERFORMANCE			
PARAMETER	SYMBOL	TYP	UNIT
Junction-to-lead thermal resistance	$R_{\theta JL}$	20	°C/W
Junction-to-ambient thermal resistance	$R_{\theta JA}$	72	°C/W

ELECTRICAL SPECIFICATIONS ($T_A = 25^\circ\text{C}$ unless otherwise noted)						
PARAMETER		CONDITIONS	SYMBOL	TYP	MAX	UNIT
Forward voltage ⁽¹⁾	SS1H4LS	$I_F = 1\text{A}, T_J = 25^\circ\text{C}$	V_F	-	0.65	V
	SS1H6LS			-	0.70	V
	SS1H10LS			-	0.80	V
	SS1H15LS SS1H20LS			-	0.85	V
Reverse current @ rated V_R ⁽²⁾	SS1H4LS SS1H6LS	$T_J = 25^\circ\text{C}$	I_R	-	1.0	μA
		$T_J = 125^\circ\text{C}$		-	0.3	mA
	SS1H10LS SS1H15LS	$T_J = 25^\circ\text{C}$		-	1.0	μA
		$T_J = 125^\circ\text{C}$		-	0.2	mA
	SS1H20LS	$T_J = 25^\circ\text{C}$		-	1.0	μA
		$T_J = 125^\circ\text{C}$		-	0.1	mA

Notes:

1. Pulse test with $PW = 0.3\text{ms}$
2. Pulse test with $PW = 30\text{ms}$

ORDERING INFORMATION		
ORDERING CODE ⁽¹⁾	PACKAGE	PACKING
SS1HxLS	SOD-123HE	10,000 / Tape & Reel

Notes:

1. "x" defines voltage from 40V(SS1H4LS) to 200V(SS1H20LS)

CHARACTERISTICS CURVES

($T_A = 25^\circ\text{C}$ unless otherwise noted)

Fig.1 Forward Current Derating Curve

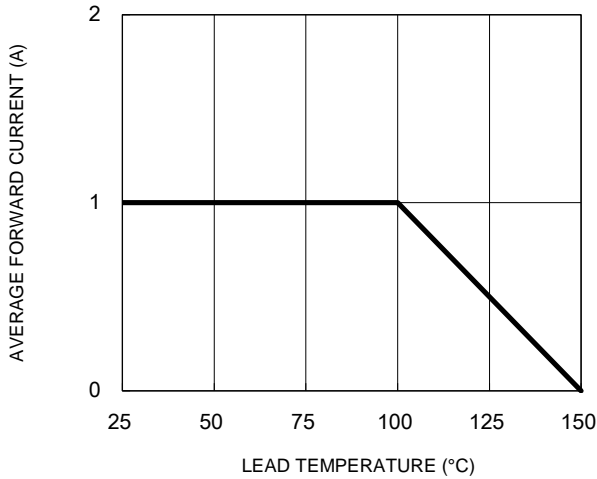

Fig.2 Typical Junction Capacitance

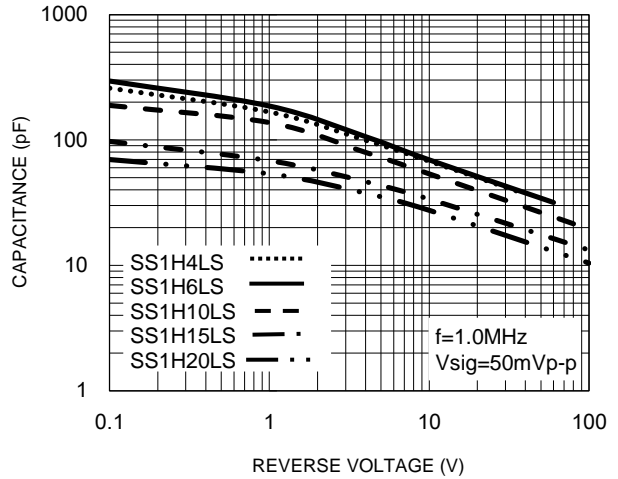

Fig.3 Typical Reverse Characteristics

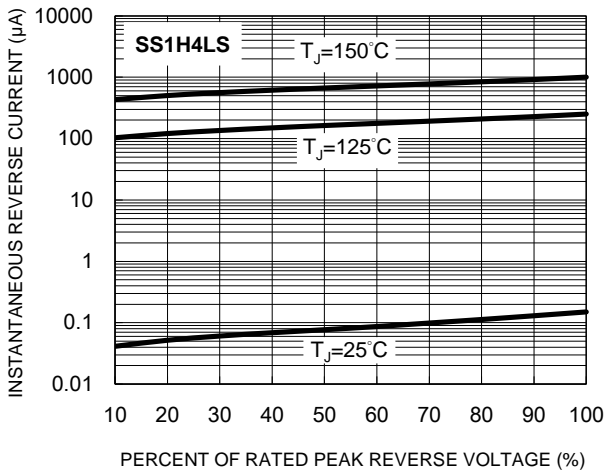

Fig.5 Typical Reverse Characteristics

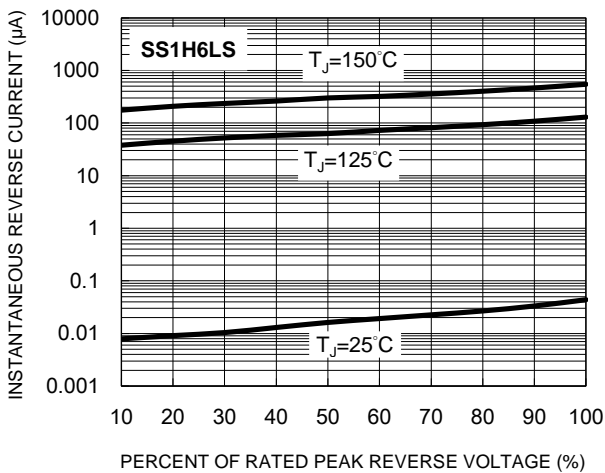

Fig.4 Typical Forward Characteristics

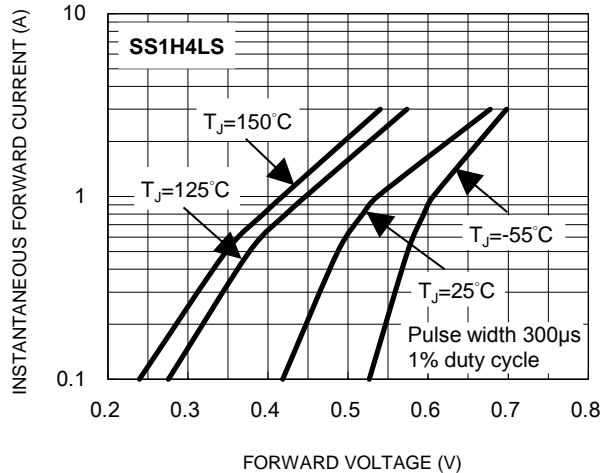
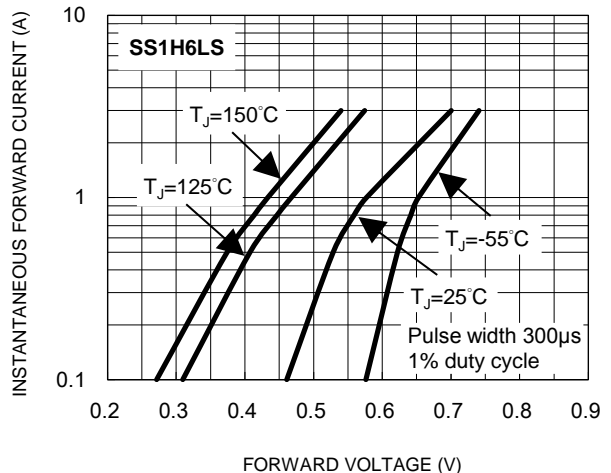

Fig.6 Typical Forward Characteristics



CHARACTERISTICS CURVES

($T_A = 25^\circ\text{C}$ unless otherwise noted)

Fig.7 Typical Reverse Characteristics

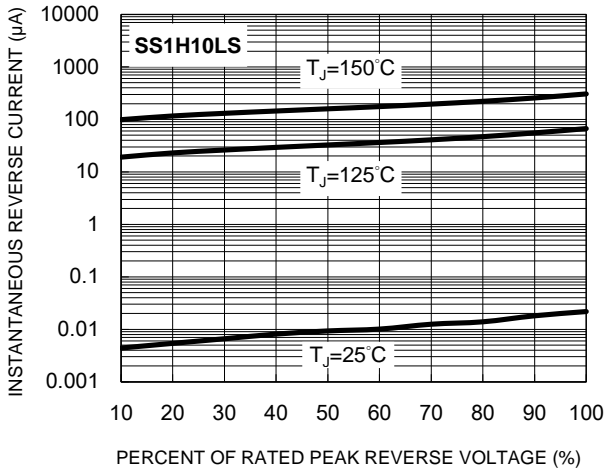

Fig.8 Typical Forward Characteristics

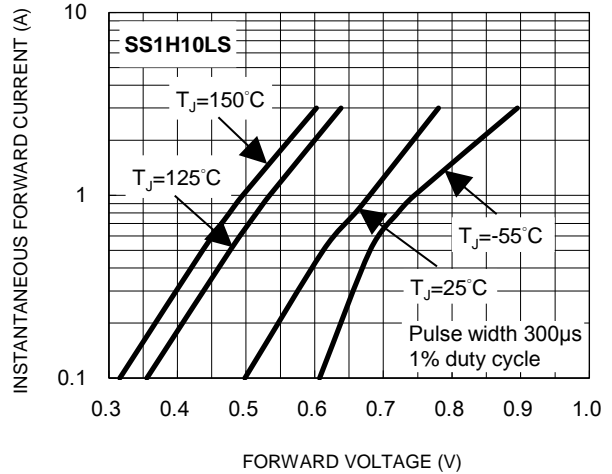

Fig.9 Typical Reverse Characteristics

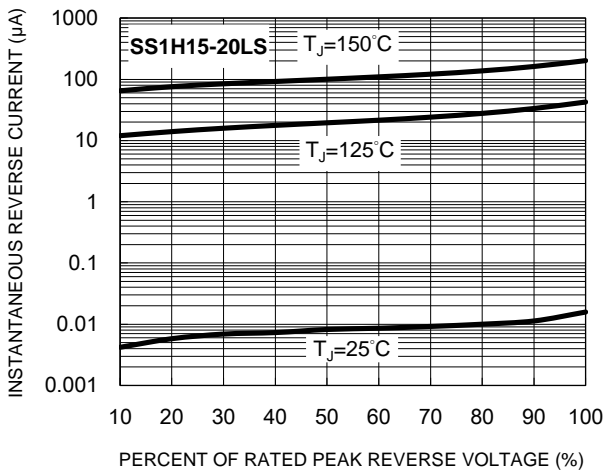

Fig.10 Typical Forward Characteristics

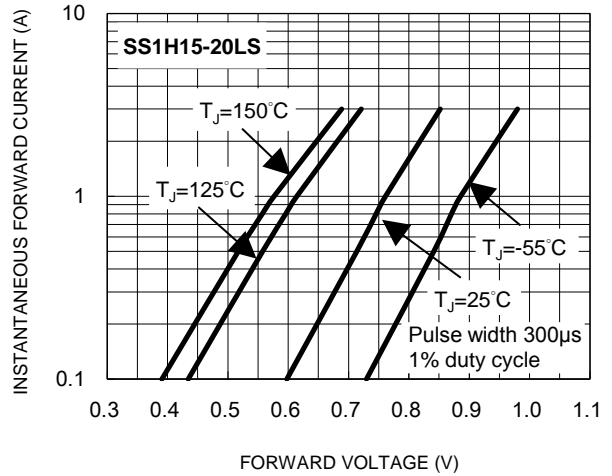
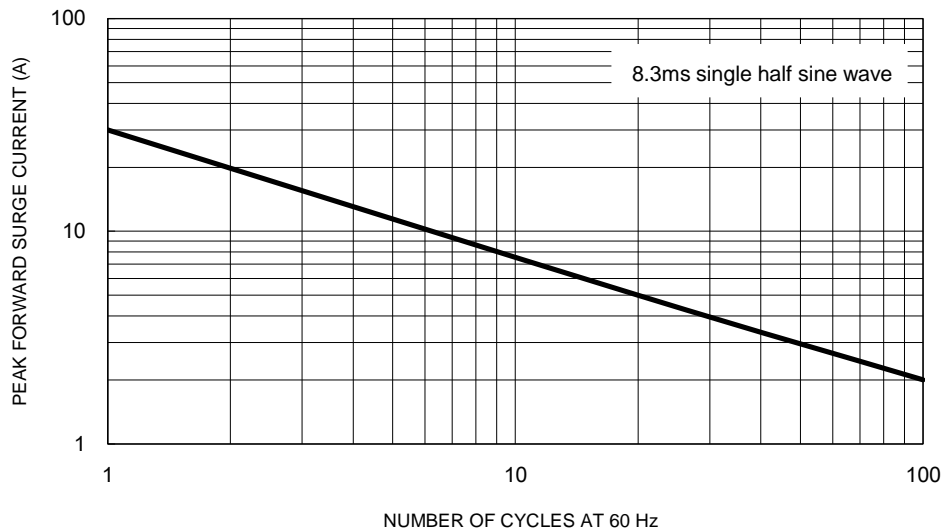
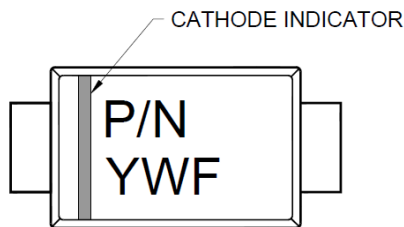
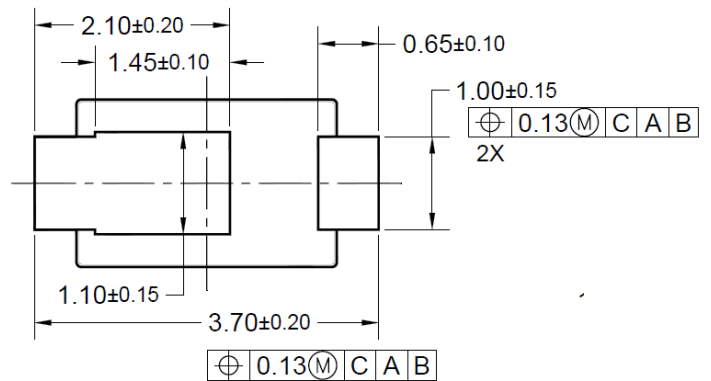
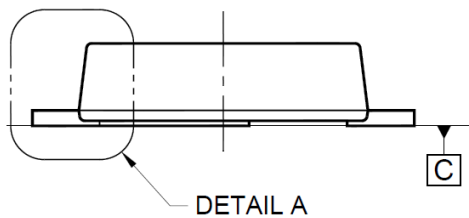
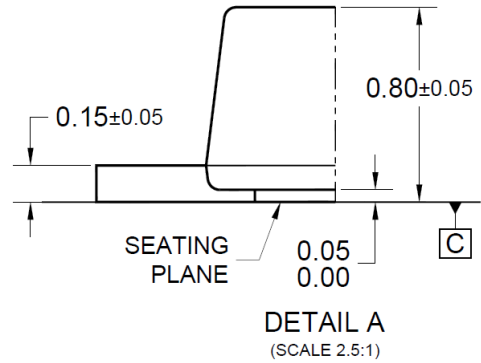
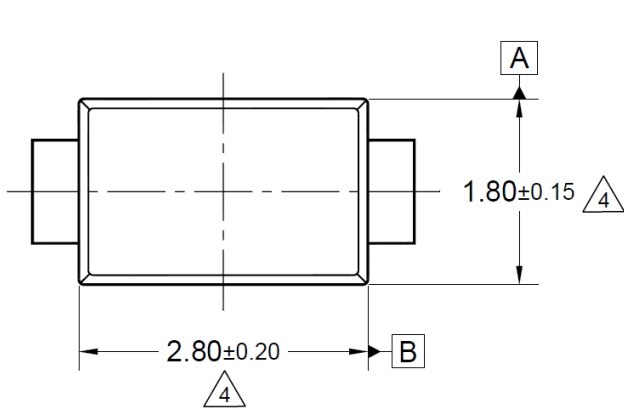

Fig.11 Maximum Non-Repetitive Forward Surge Current



PACKAGE OUTLINE DIMENSIONS

SOD-123HE



MARKING DIAGRAM

P/N = MARKING CODE
YWF = DATE CODE
F = FACTORY CODE

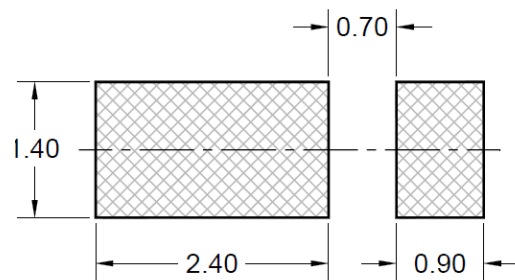

SUGGESTED PAD LAYOUT

NOTES: UNLESS OTHERWISE SPECIFIED

1. ALL DIMENSIONS ARE IN MILLIMETERS.
2. DIMENSIONING AND TOLERANCING PER ASME Y14.5M-2009.
3. THERE IS NO EXISTING INDUSTRY STANDARD FOR THIS PACKAGE.
4. MOLDED PLASTIC BODY DIMENSIONS DO NOT INCLUDE MOLD FLASH.
5. DWG NO. REF: HQ2SD07-SOD123HE-038 REV A.

Notice

Specifications of the products displayed herein are subject to change without notice. TSC or anyone on its behalf, assumes no responsibility or liability for any errors or inaccuracies.

Purchasers are solely responsible for the choice, selection, and use of TSC products and TSC assumes no liability for application assistance or the design of Purchasers' products.

Information contained herein is intended to provide a product description only. No license, express or implied, to any intellectual property rights is granted by this document. Except as provided in TSC's terms and conditions of sale for such products, TSC assumes no liability whatsoever, and disclaims any express or implied warranty, relating to sale and/or use of TSC products including liability or warranties relating to fitness for a particular purpose, merchantability, or infringement of any patent, copyright, or other intellectual property right.

The products shown herein are not designed for use in medical, life-saving, or life-sustaining applications. Customers using or selling these products for use in such applications do so at their own risk and agree to fully indemnify TSC for any damages resulting from such improper use or sale.