

FEATURES

- 1 GHz Specified Performance
- Flat Gain
- Very Low Distortion
- Excellent Input/Output Match
- Low DC Power Consumption
- Good RF Stability with High VSWR Load Conditions
- Surface Mount Package Compatible with Automatic Assembly
- Low Cost
- Repeatability of Monolithic Fabrication
- Meets Cenelec Standard
- RoHS-Compliant Packaging



PRODUCT DESCRIPTION

The ACA0862 family of surface mount monolithic GaAs RF Linear Amplifiers has been developed to replace, in new designs, the standard CATV Hybrid amplifiers currently in use. The ACA0862 can also replace the ACA0861 with the addition of tuning capacitors to the output (see Figure 3). The MMICs consist of two parallel amplifiers, each with 12 dB gain. The Amplifiers are optimized for exceptionally low distortion and noise figure while providing flat gain and excellent input and output return loss. The ACA0862B

and ACA0862D are optimized for different output powers, and can be used separately or cascaded to support a variety of applications. A Hybrid equivalent is formed when two ACA0862 devices are cascaded between transmission line baluns. For low gain applications a single ACA0862 can be used; for higher gain applications more than two can be cascaded. See the ACA0861 application note for more information.

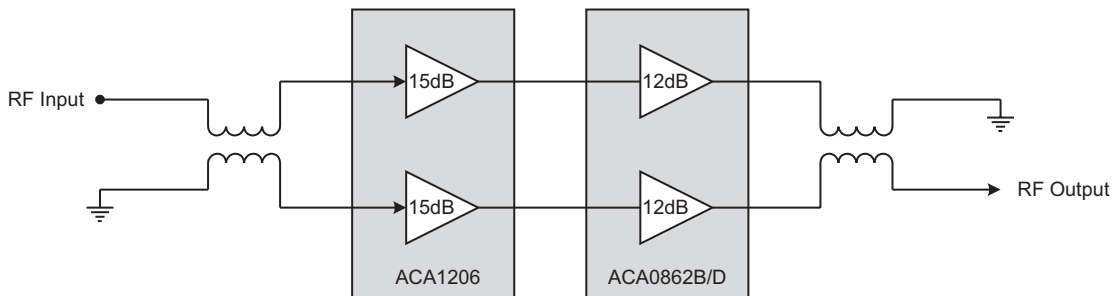

Figure 1: Hybrid Application Diagram

Output Stages

The ACA0862B and ACA0862D are designed as output stage amplifiers. These parts can be used alone for low gain, high output level applications or can be cascaded with an ACA1206 input stage amplifier for higher gain. The ACA0862B is a low power dissipation part, while the ACA0862D is a higher power dissipation part. Cascaded, an ACA1206 and ACA0862B provide

exceptional push-pull hybrid equivalent performance; an ACA1206 and an ACA0862D cascade provides exceptional power doubling hybrid equivalent performance. An ACA0862B can also be cascaded with an ACA0862D to create a power doubler with even better distortion performance.

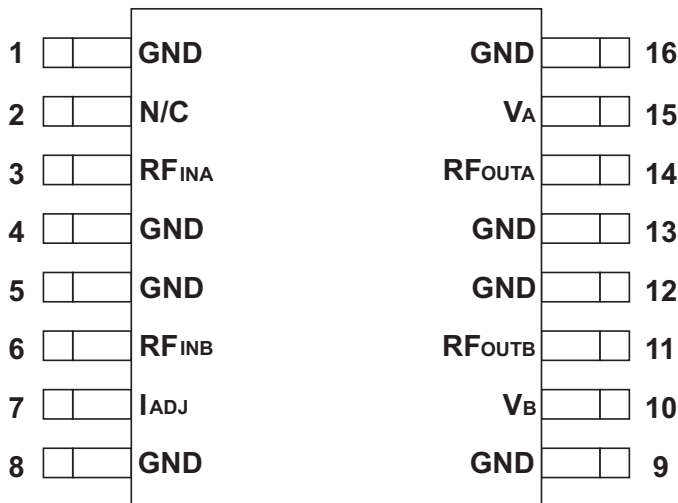

Figure 2: Pin Out

Table 1: Pin Description

PIN	NAME	DESCRIPTION	PIN	NAME	DESCRIPTION
1	GND	Ground	9	GND	Ground
2	N/C	No Connection	10	V _B	Supply for Amplifier B
3	RF _{INA}	Input to Amplifier A	11	RF _{OUTB}	Output from Amplifier B
4	GND	Ground	12	GND	Ground
5	GND	Ground	13	GND	Ground
6	RF _{INB}	Input to Amplifier B	14	RF _{OUTA}	Output from Amplifier A
7	I _{ADJ}	Current Adjust	15	V _A	Supply for Amplifier A
8	GND	Ground	16	GND	Ground

ELECTRICAL CHARACTERISTICS

Table 2: Absolute Minimum and Maximum Ratings

PARAMETER	MIN	MAX	UNIT
Amplifier Supplies (pins 10, 11, 14, 15)	0	+15	VDC
RF Input Power (pins 3, 6)	-	+70	dBmV
Storage Temperature	-65	+150	°C
Soldering Temperature	-	+260	°C
Soldering Time	-	5.0	sec

Stresses in excess of the absolute ratings may cause permanent damage. Functional operation is not implied under these conditions. Exposure to absolute ratings for extended periods of time may adversely affect reliability.

Notes:

(1) Pins 3 and 6 should be AC-coupled. No external DC bias should be applied.

(2) Pin 7 must be terminated through a resistor to either V_D or GND.

P/N	Resistor (Pin7)	Termination
ACA0862B	4.32K(R1)	GND
ACA0862D	9.09K(R2)	VD

Refer to figure 17 (Test Circuit) and Table 6, page 8.

Table 3: Operating Ranges

PARAMETER	MIN	TYP	MAX	UNIT
RF Frequency	40	-	1000	MHz
Supply: V _D (pins 10, 11, 14, 15)	-	+12	-	VDC
Operating Temperature: T _A	-40	-	+110	°C

The device may be operated safely over these conditions; however, parametric performance is guaranteed only over the conditions defined in the electrical specifications.

Table 4: Electrical Specifications
(T_A = +25 °C, V_D = +12 VDC)

PARAMETER	ACA0862B			ACA0862D			UNIT	COMMENTS
	MIN	TYP	MAX	MIN	TYP	MAX		
Gain ⁽¹⁾	10.7	-	11.7	10.8	-	11.8	dB	
Gain Flatness ⁽¹⁾	-	-	±0.3	-	-	±0.3	dB	
Noise Figure ⁽¹⁾	-	4	4.5	-	4	4.5	dB	
CTB ^{(1), (2)} 77 Channels 110 Channels 128 Channels	- - -	- - -	-70 -71 -	- - -	-81 -76 -	-78 -73 -	dBc	
CSO ^{(1), (2)} 77 Channels 110 Channels 128 Channels	- - -	- - -	-68 -66 -	- - -	-71 -63 -	-68 -56 -	dBc	
XMOD ^{(1), (2)} 77 Channels 110 Channels 128 Channels	- - -	- - -	-65 -68 -	- - -	-74 -74 -	-72 -71 -	dBc	
Supply Current ⁽³⁾	-	395	445	-	530	610	mA	
Cable Equivalent Slope ⁽¹⁾	-0.5	-	1.0	-0.5	-	1.0	dB	
Return Loss (Input/Output) ⁽¹⁾	18	22	-	18	22	-	dB	
Thermal Resistance (θ _{JC})	-	-	6.0	-	-	6.0	°C/W	

Notes:

- (1) Measured with a balun on input and output of the device. See Figure 3 for test setup.
(2) "B" device measured with 79 analog channels, +47 dBmV output power at 1002 MHz with a 3 dB tilt and QAM to 1002 MHz. "D" device measured with 79 analog channels, +56 dBmV output power at 1002 MHz with a 15.6 dB tilt and QAM to 1002 MHz. QAM channels are -6 dB relative to analog channels.
(3) A fixed resistor is needed (see Table 6) to set the devices' current draw. Bias voltage is +12 VDC.

Figure 3: ACA0862B P1dB vs Frequency

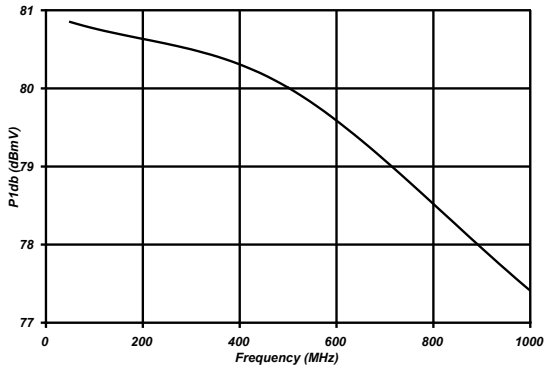

Figure 4: ACA0862D P1dB vs Frequency

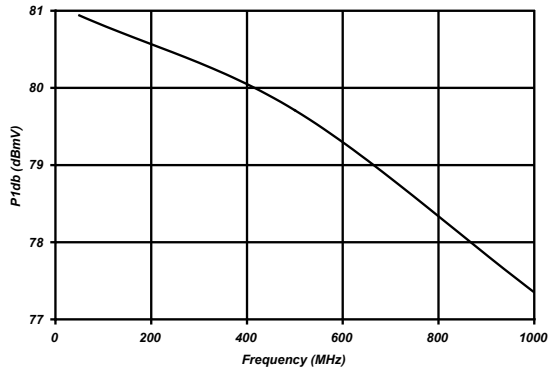

Figure 5: ACA0862B MER - 64 QAM @ 85 MHz

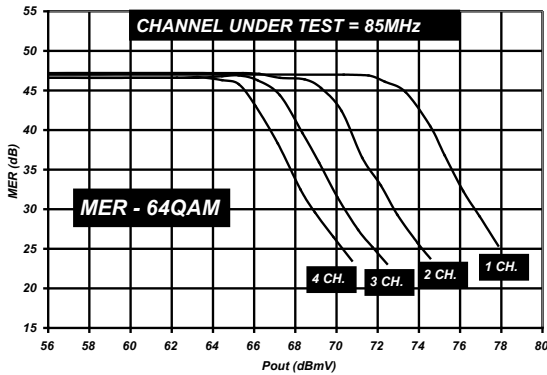

Figure 6: ACA0862D MER - 64 QAM @ 85 MHz

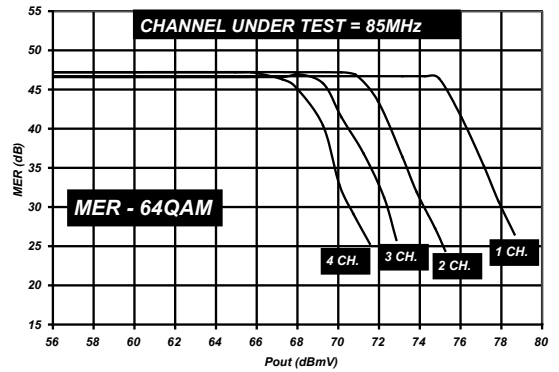

Figure 7: ACA0862B MER - 64 QAM @ 543 MHz

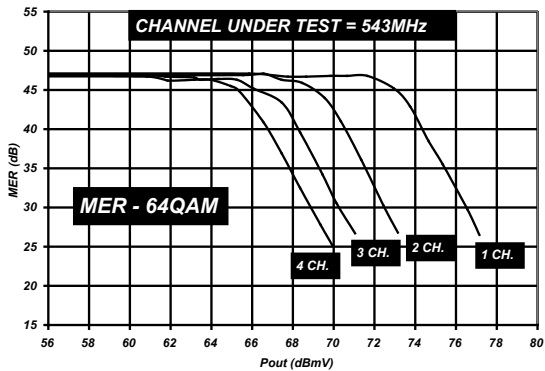

Figure 8: ACA0862D MER - 64 QAM @ 543 MHz

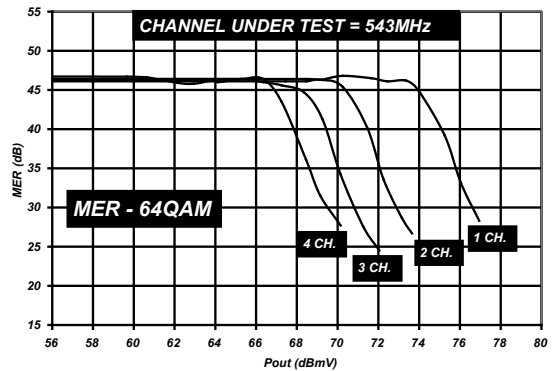

Figure 9: ACA0862B MER - 64 QAM @ 987 MHz

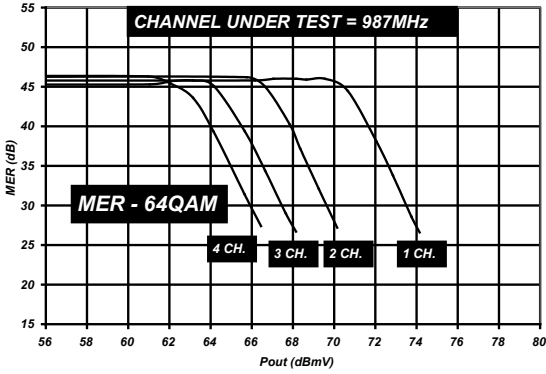

Figure 10: ACA0862D MER - 64 QAM @ 987 MHz

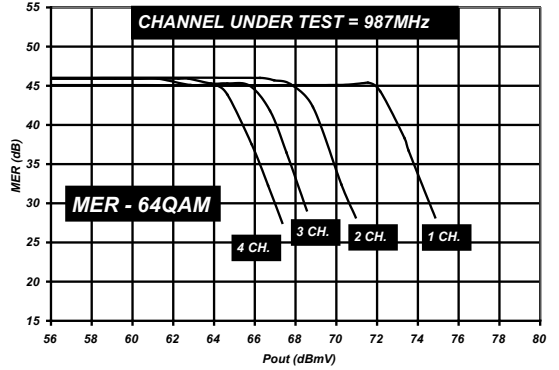

Figure 11: ACA0862B MER - 256 QAM @ 85 MHz

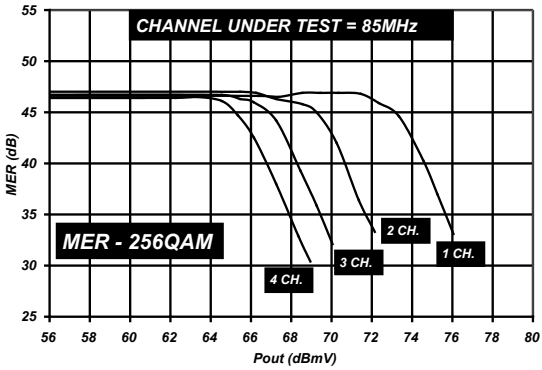

Figure 12: ACA0862D MER - 256 QAM @ 85 MHz

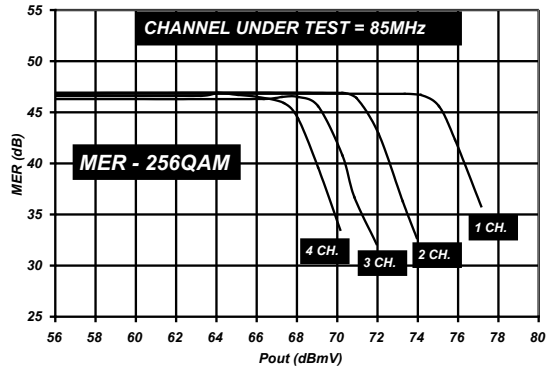

Figure 13: ACA0862B MER - 256 QAM @ 543 MHz

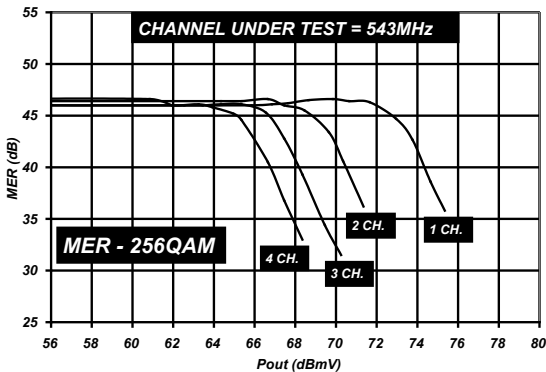

Figure 14: ACA0862D MER - 256 QAM @ 543 MHz

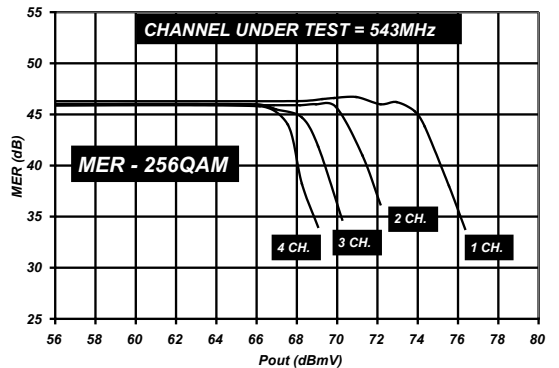

Figure 15: ACA0862B MER - 256 QAM @ 987 MHz

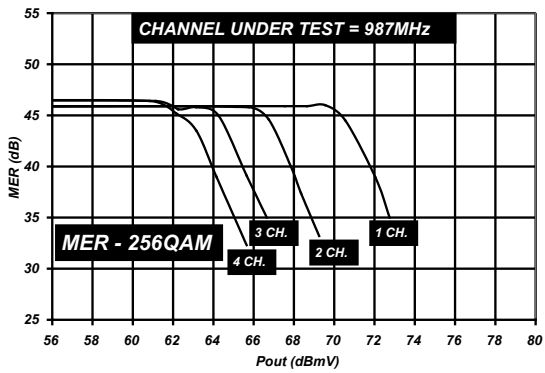
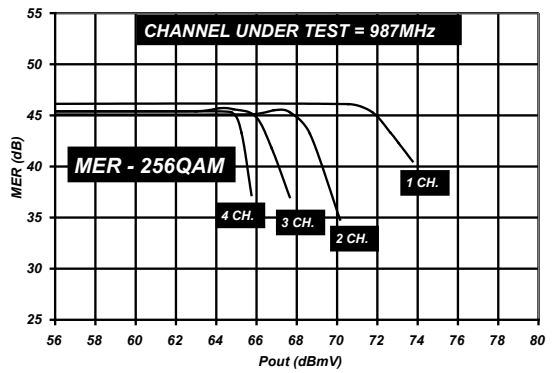
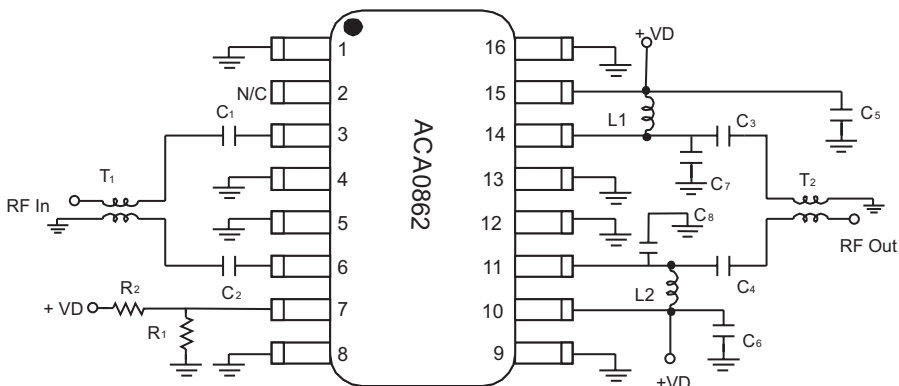

Figure 16: ACA0862D MER - 256 QAM @ 987 MHz





Note: Apply voltage to both V_D lines simultaneously.

Figure 17: Test Circuit

Table 5: Parts List for Test Circuit

REF	DESCRIPTION	QTY	VENDOR	VENDOR PART NO.
C1, C2, C5, C6	0.01 μF chip capacitor	4	Murata	GRM39X7R1103K25V
C3, C4	300 pF chip capacitor	2	Murata	GRM39X7R301K25V
C7, C8	1.5 pF chip capacitor	2	Murata	GRM1885C1H1R5C201B
L1, L2	390nH air-wound chip inductor	2	Coilcraft	1008CS-39 1
R1, R2	(see Table 6)	1		
T1, T2 ⁽¹⁾⁽²⁾	ferrite core	2	Fair-Rite	2843002702
	wire		MWS Wire industries	T-2361429-20

Notes:

- (1) T1, T2 (balun) wind 5.5 turns thru core, as shown in Figure 18.
- (2) T1, T2 baluns can be replaced with M/A COM 009210

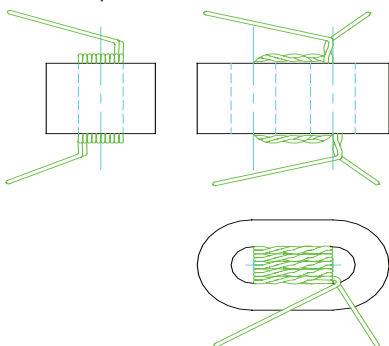

DIMENSIONS ARE IN INCHES

NOTES:

- 1. MATERIAL:
 CORE: FAIR-RITE (2843002702)
 WIRE: MWS WIRE IND.
 T-2361429-20
 5.5 TIMES THRU AS SHOWN.

DIMENSIONING AND TOLERANCING PER ASME Y14.5M-1994

Figure 18: Balun Drawing (5.5 Turns)

Table 6: R1, R2 Resistor Value

PART NUMBER	R1 VALUE	R2 VALUE
ACA0862B	4.32 kOhm	(open)
ACA0862D	(open)	9.09 kOhm

Notes:

- (1) R2 can be adjusted in the ACA0862D test circuit to set the device current draw up to 610 mA.

APPLICATION INFORMATION

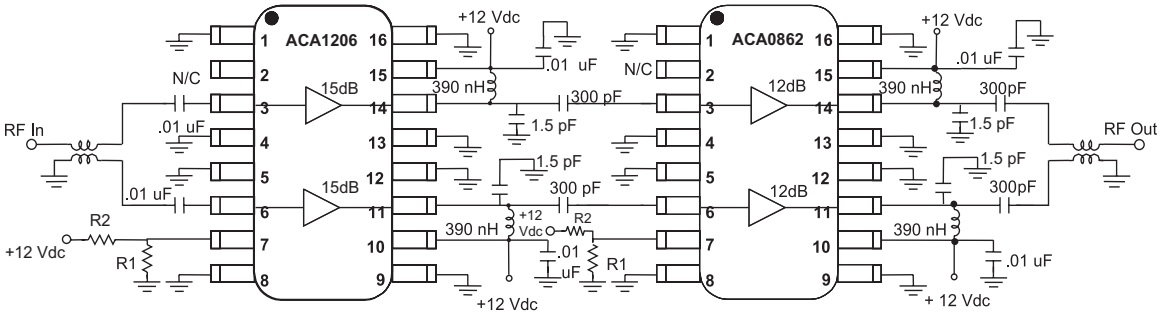

Notes:

- (1) Apply voltage to all +12 Vdc lines simultaneously.
- (2) See Table 6 for R1 and R2 values.
- (3) Input and output baluns: wind 5.5 turns thru core (see Table 7), as shown in Figure 6.

Figure 19: Hybrid Equivalent Test Circuit

Table 7: Parts List for Balun (5.5 Turns)

PART	VENDOR	VENDOR PART NO.
ferrite core	Fair-Rite	2843002702
wire	MWS Wire industries	T-2361429-20

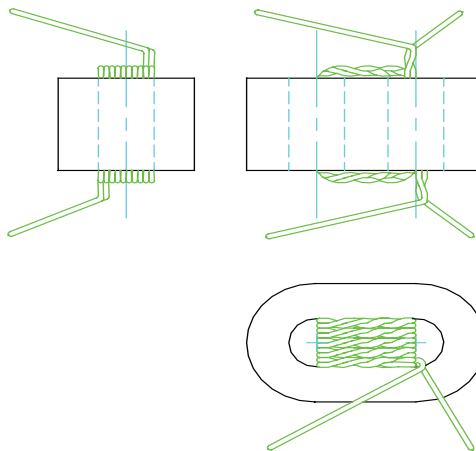

NOTES:

- 1. MATERIAL:
 CORE: FAIR-RITE (2843002702)
 WIRE: MWS WIRE IND.
 T-2361429-20
 5.5 TIMES THRU AS SHOWN.

DIMENSIONS ARE IN INCHES

DIMENSIONING AND TOLERANCING PER ASME Y14.5M-1994

Figure 20: Balun Drawing (5.5 Turns)

PACKAGE OUTLINE

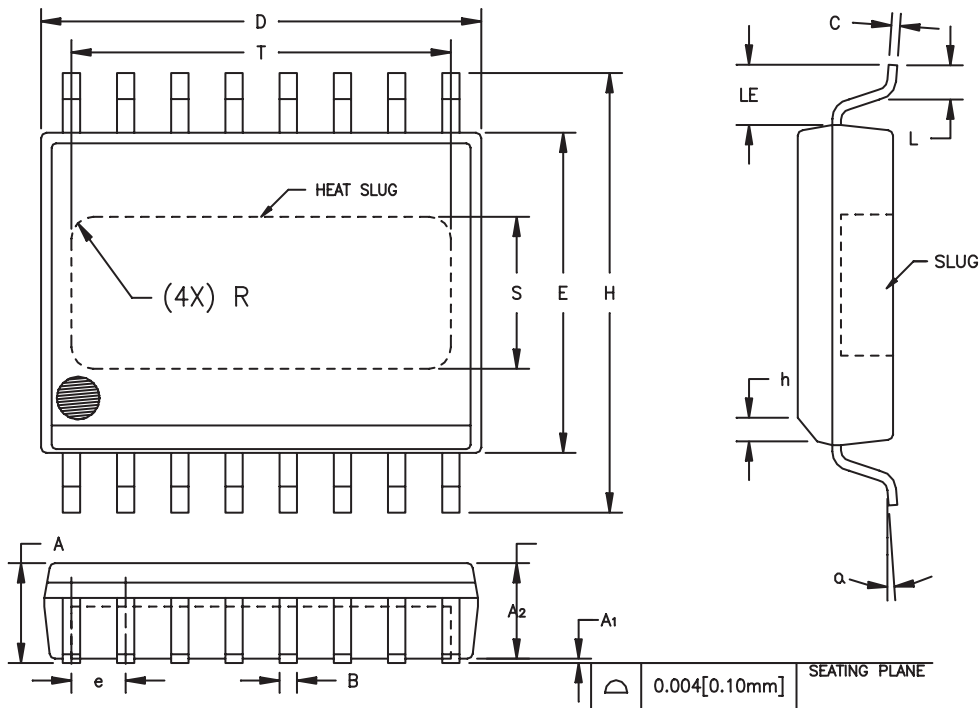

SYMBOL	INCHES		MILLIMETERS		NOTE
	MIN.	MAX.	MIN.	MAX.	
A	0.087	0.098	2.21	2.49	
A ₁	0.000	0.004	0.00	0.10	6
A ₂	0.087	0.094	2.21	2.39	
B	0.013	0.019	0.33	0.48	
C	0.007	0.009	0.18	0.23	
D	0.398	0.412	10.11	10.46	2
E	0.290	0.300	7.37	7.62	3
e	0.050 BSC		1.27 BSC		4
H	0.394	0.418	10.01	10.62	
h	0.010	0.028	0.25	0.71	
L	0.024	0.040	0.61	1.02	
LE	0.052	—	1.32	—	
α	0°	8°	0°	8°	
S	0.120	0.140	3.05	3.56	5
T	0.330	0.350	8.38	8.89	5
R	REF.	0.015	REF.	0.38	5

NOTES:

1. CONTROLLING DIMENSION: INCHES
2. DIMENSION "D" DOES NOT INCLUDE MOLD FLASH, PROTRUSIONS OR GATE BURRS. MOLD FLASH, PROTRUSIONS AND GATE BURRS SHALL NOT EXCEED 0.006 [0.15mm] PER SIDE.
3. DIMENSION "E" DOES NOT INCLUDE INTER-LEAD FLASH OR PROTRUSIONS. INTER-LEAD FLASH AND PROTRUSIONS SHALL NOT EXCEED 0.010 [0.25mm] PER SIDE.
4. MAXIMUM LEAD TWIST/SKEW TO BE ±0.005 [0.13mm].
5. DIMENSIONS "S", "T" AND "R" INDICATE EXPOSED SLUG AREA.
6. STANDOFF HEIGHT (A₁) MEASURED FROM BOTTOM OF SLUG.

Figure 21: S7 Package Outline - 16 Pin Wide Body SOIC with Heat Slug

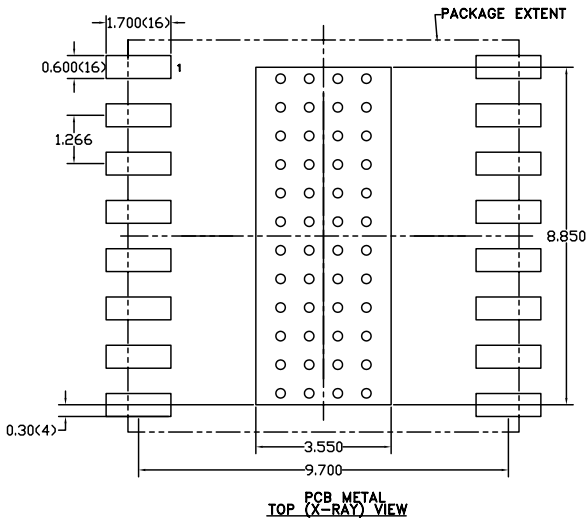

NOTES:

- (1) OUTLINE DRAWING REFERENCE: 98001-014
- (2) UNLESS SPECIFIED DIMENSIONS ARE SYMMETRICAL ABOUT CENTER LINES SHOWN.
- (3) DIMENSIONS IN MILLIMETERS.
- (4) VIAS SHOWN IN PCB METAL VIEW ARE FOR REFERENCE ONLY. NUMBER & SIZE OF THERMAL VIAS REQUIRED DEPENDENT ON HEA DISSIPATION REQUIREMENT AND THE PC PROC SS CAPABILITY.
- (5) RECOMMENDED STENCIL THICKNESS: APPROX. 0.125mm (5 Mils)

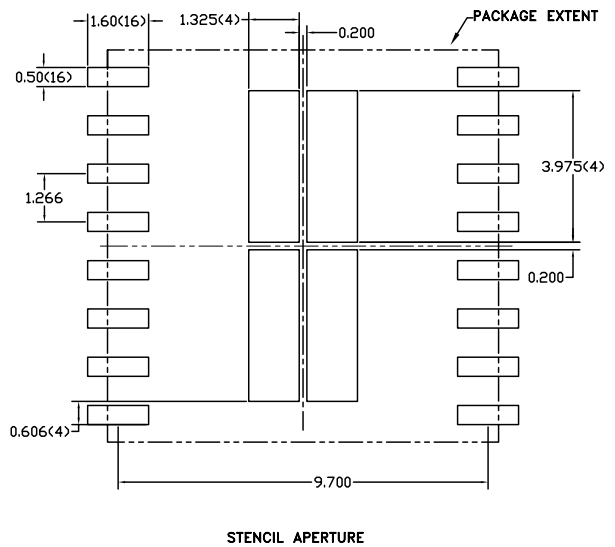
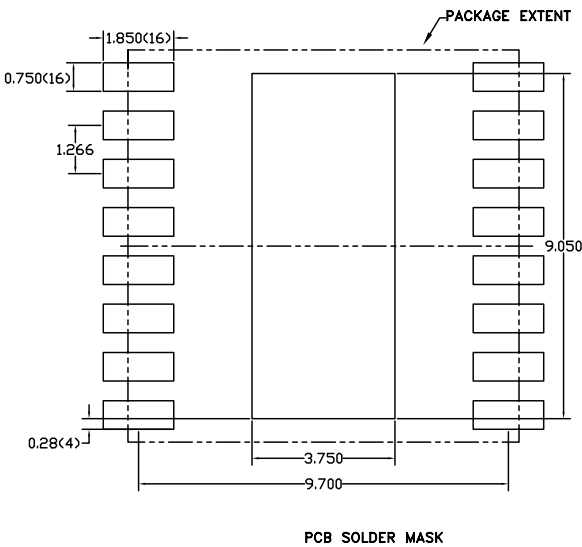

Figure 22: S7 Package Outline - 16 Pin Wide Body SOIC with Heat Slug

ORDERING INFORMATION

ORDER NUMBER	TEMPERATURE RANGE	PACKAGE DESCRIPTION	COMPONENT PACKAGING
ACA0862BRS7P2	-40 to 110 °C	RoHS-Compliant 16 Pin wide Body SOIC with Heat Slug	1,500 piece tape and reel
ACA0862DRS7P2	-40 to 110 °C	RoHS-Compliant 16 Pin wide Body SOIC with Heat Slug	1,500 piece tape and reel

NOTES

Copyright © 2016 Skyworks Solutions, Inc. All Rights Reserved.

Information in this document is provided in connection with Skyworks Solutions, Inc. ("Skyworks") products or services. These materials, including the information contained herein, are provided by Skyworks as a service to its customers and may be used for informational purposes only by the customer. Skyworks assumes no responsibility for errors or omissions in these materials or the information contained herein. Skyworks may change its documentation, products, services, specifications or product descriptions at any time, without notice. Skyworks makes no commitment to update the materials or information and shall have no responsibility whatsoever for conflicts, incompatibilities, or other difficulties arising from any future changes.

No license, whether express, implied, by estoppel or otherwise, is granted to any intellectual property rights by this document. Skyworks assumes no liability for any materials, products or information provided hereunder, including the sale, distribution, reproduction or use of Skyworks products, information or materials, except as may be provided in Skyworks Terms and Conditions of Sale.

THE MATERIALS, PRODUCTS AND INFORMATION ARE PROVIDED "AS IS" WITHOUT WARRANTY OF ANY KIND, WHETHER EXPRESS, IMPLIED, STATUTORY, OR OTHERWISE, INCLUDING FITNESS FOR A PARTICULAR PURPOSE OR USE, MERCHANTABILITY, PERFORMANCE, QUALITY OR NON-INFRINGEMENT OF ANY INTELLECTUAL PROPERTY RIGHT; ALL SUCH WARRANTIES ARE HEREBY EXPRESSLY DISCLAIMED. SKYWORKS DOES NOT WARRANT THE ACCURACY OR COMPLETENESS OF THE INFORMATION, TEXT, GRAPHICS OR OTHER ITEMS CONTAINED WITHIN THESE MATERIALS. SKYWORKS SHALL NOT BE LIABLE FOR ANY DAMAGES, INCLUDING BUT NOT LIMITED TO ANY SPECIAL, INDIRECT, INCIDENTAL, STATUTORY, OR CONSEQUENTIAL DAMAGES, INCLUDING WITHOUT LIMITATION, LOST REVENUES OR LOST PROFITS THAT MAY RESULT FROM THE USE OF THE MATERIALS OR INFORMATION, WHETHER OR NOT THE RECIPIENT OF MATERIALS HAS BEEN ADVISED OF THE POSSIBILITY OF SUCH DAMAGE.

Skyworks products are not intended for use in medical, lifesaving or life-sustaining applications, or other equipment in which the failure of the Skyworks products could lead to personal injury, death, physical or environmental damage. Skyworks customers using or selling Skyworks products for use in such applications do so at their own risk and agree to fully indemnify Skyworks for any damages resulting from such improper use or sale.

Customers are responsible for their products and applications using Skyworks products, which may deviate from published specifications as a result of design defects, errors, or operation of products outside of published parameters or design specifications.

Customers should include design and operating safeguards to minimize these and other risks. Skyworks assumes no liability for applications assistance, customer product design, or damage to any equipment resulting from the use of Skyworks products outside of stated published specifications or parameters.

Skyworks and the Skyworks symbol are trademarks or registered trademarks of Skyworks Solutions, Inc., in the United States and other countries. Third-party brands and names are for identification purposes only, and are the property of their respective owners. Additional information, including relevant terms and conditions, posted at www.skyworksinc.com, are incorporated by reference.

Skyworks Solutions, Inc.

Phone [781] 376-3000 • Fax [781] 376-3100 • sales@skyworksinc.com • www.skyworksinc.com

Skyworks Proprietary and Confidential information • Products and Product Information are Subject to Change Without Notice