

Powerex, Inc., 200 Hillis Street, Youngwood, Pennsylvania 15697-1800 (412) 925-7272  
 Powerex, Europe, S.A. 428 Avenue G. Durand, BP107, 72003 Le Mans, France (43) 41.14.14

**Phase Control SCR**  
 1800 Amperes Average  
 2200 Volts

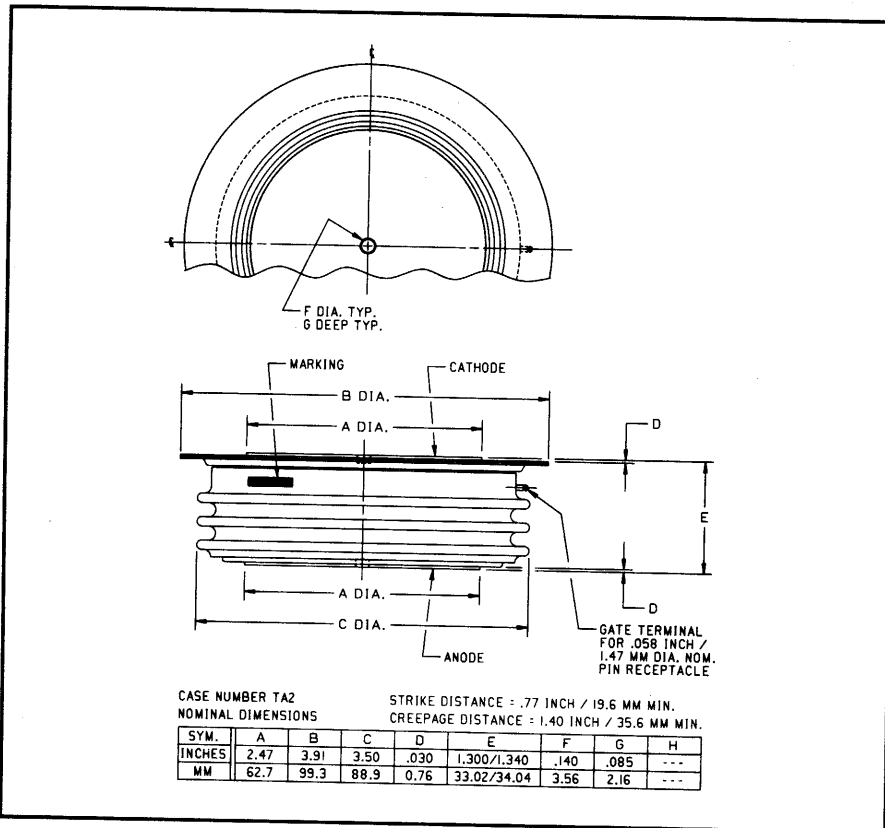

TA20 1800A (Outline Drawing)

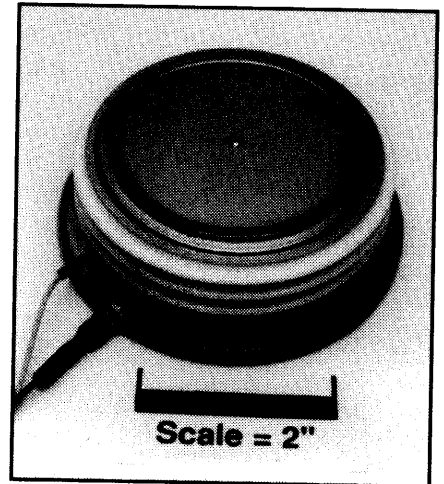

TA20 1800A Phase Control SCR  
 1800 Amperes Average, 2200 Volts

### Description:

Powerex Silicon Controlled Rectifiers (SCR) are designed for phase control applications. These are all-diffused, Press-Pak, hermetic Pow-R-Disc devices employing the field proven amplifying gate.

### Features:

- Low On-State Voltage
- High di/dt Capability
- High dv/dt Capability
- Hermetic Packaging
- Excellent Surge  $I^2t$  Ratings

### Applications:

- Power Supplies
- Motor Control

### Ordering Information:

Select the complete 12 digit part number you desire from the table below.

Type	Voltage	Current	Turn-off	Gate Current	Lead Code
	$V_{DRM}/V_{RRM}$ (Volts)	$I_T(av)$ (A)	$t_q$ ( $\mu$ sec)	$I_{GT}$ (mA)	
TA20	02 through 22	18	0	3	DH
	200V through 2200V	1800A	250 $\mu$ sec (Typical)	200mA	12"



Powerex, Inc., 200 Hillis Street, Youngwood, Pennsylvania 15697-1800 (412) 925-7272  
 Powerex, Europe, S.A. 428 Avenue G. Durand, BP107, 72003 Le Mans, France (43) 41.14.14

**TA20 1800A**  
**Phase Control SCR**  
 1800 Amperes Average, 2200 Volts

### Absolute Maximum Ratings

Characteristics	Symbol	TA20 1800A	Units
Non-repetitive Transient Peak Reverse Voltage	$V_{RSM}$	$V_{RRM} + 100V$	Volts
RMS On-state Current, $T_C = 85^\circ C$	$I_{T(rms)}$	2820	Amperes
Average Current 180° Sine Wave, $T_C = 85^\circ C$	$I_{T(av)}$	1800	Amperes
RMS On-state Current, $T_C = 55^\circ C$	$I_{T(rms)}$	4200	Amperes
Average Current 180° Sine Wave, $T_C = 55^\circ C$	$I_{T(av)}$	2675	Amperes
Peak One Cycle Surge On-state Current (Non-repetitive) 60Hz	$I_{tsm}$	40000	Amperes
Peak One Cycle Surge On-state Current (Non-repetitive) 50Hz	$I_{tsm}$	36500	Amperes
Critical Rate-of-rise of On-state Current (Non-repetitive)	$di/dt$	400	A/ $\mu$ sec
Critical Rate-of-rise of On-state Current (Repetitive)	$di/dt$	150	A/ $\mu$ sec
$I^2t$ (for Fusing) for One Cycle, 60Hz	$I^2t$	$6.67 \times 10^6$	A <sup>2</sup> sec
Peak Gate Power Dissipation	$P_{GM}$	16	Watts
Average Gate Power Dissipation	$P_{G(av)}$	3	Watts
Operating Temperature	$T_j$	-40 to +125°C	°C
Storage Temperature	$T_{stg}$	-40 to +150°C	°C
Approximate Weight		2.1	lb.
		950	g
Mounting Force		9000 to 11000	lb.
		4100 to 5000	kg.



Powerex, Inc., 200 Hillis Street, Youngwood, Pennsylvania 15697-1800 (412) 925-7272  
 Powerex, Europe, S.A. 428 Avenue G. Durand, BP107, 72003 Le Mans, France (43) 41.14.14

TA20 1800A  
 Phase Control SCR  
 1800 Amperes Average, 2200 Volts

### Electrical Characteristics, T<sub>j</sub> = 25°C Unless Otherwise Specified

Characteristics	Symbol	Test Conditions	Min.	Typ.	Max.	Units
Repetitive Peak Reverse Leakage Current	I <sub>RRM</sub>	T <sub>j</sub> = 125°C, V <sub>R</sub> = V <sub>RRM</sub>			100	mA
Repetitive Peak Forward Leakage Current	I <sub>DRM</sub>	T <sub>j</sub> = 125°C, V <sub>D</sub> = V <sub>DRM</sub>			100	mA
Peak On-state Voltage	V <sub>TM</sub>	I <sub>TM</sub> = 3000A Peak Duty Cycle < 0.1%			1.45	Volts
Threshold Voltage, Low-level	V <sub>(TO)1</sub>	T <sub>j</sub> = 125°C, I = 15%, I <sub>T(av)</sub> to πI <sub>T(av)</sub>			0.71870	Volts
Slope Resistance, Low-level	r <sub>T1</sub>				0.1669	mΩ
Threshold Voltage, High-level	V <sub>(TO)2</sub>	T <sub>j</sub> = 125°C, I = πI <sub>T(av)</sub> to I <sub>TSM</sub>			0.97647	Volts
Slope Resistance, High-level	r <sub>T2</sub>				0.1215	mΩ
V <sub>TM</sub> Coefficients, Low-level		T <sub>j</sub> = 125°C, I = 15% I <sub>T(av)</sub> to πI <sub>T(av)</sub>				A <sub>1</sub> = 1.0791 B <sub>1</sub> = -0.12551 C <sub>1</sub> = 3.874E-06 D <sub>1</sub> = 0.02151
V <sub>TM</sub> Coefficients, High-level		T <sub>j</sub> = 125°C, I = πI <sub>T(av)</sub> to I <sub>TSM</sub>				A <sub>2</sub> = -6.7846 B <sub>2</sub> = 1.1619 C <sub>2</sub> = 1.858E-04 D <sub>2</sub> = -0.03560
Typical Turn-on Time	t <sub>on</sub>	I <sub>T</sub> = 1000A, V <sub>D</sub> = 1500V		4		μsec
Typical Turn-off Time	t <sub>q</sub>	T <sub>j</sub> = 125°C, I <sub>T</sub> = 250A, di <sub>R</sub> /dt = 50A/μsec Reapplied dv/dt = 20V/μsec Linear to 80% V <sub>DRM</sub>		250		μsec
Minimum Critical dv/dt - Exponential to V <sub>DRM</sub>	dv/dt	T <sub>j</sub> = 125°C	300			V/μsec
Gate Trigger Current	I <sub>GT</sub>	T <sub>j</sub> = 25°C, V <sub>D</sub> = 12V			200	mA
Gate Trigger Voltage	V <sub>GT</sub>	T <sub>j</sub> = 25°C, V <sub>D</sub> = 12V			3.0	Volts
Non-Triggering Gate Voltage	V <sub>GDM</sub>	T <sub>j</sub> = 125°C, V <sub>D</sub> = V <sub>DRM</sub>			0.15	Volts
Peak Forward Gate Current	I <sub>GTM</sub>				4	A
Peak Reverse Gate Voltage	V <sub>GDM</sub>				5	Volts

### Thermal Characteristics

Maximum Thermal Resistance, Double Sided Cooling

Junction-to-Case	R <sub>θ(j-c)</sub>		0.015	°C/W
Case-to-Sink	R <sub>θ(c-s)</sub>		0.007	°C/W

Powerex, Inc., 200 Hillis Street, Youngwood, Pennsylvania 15697-1800 (412) 925-7272  
 Powerex, Europe, S.A. 428 Avenue G. Durand, BP107, 72003 Le Mans, France (43) 41.14.14

**TA20 1800A**  
**Phase Control SCR**  
 1800 Amperes Average, 2200 Volts

**Maximum On-State Forward Voltage Drop**  
 (T<sub>J</sub> = 125 °C)

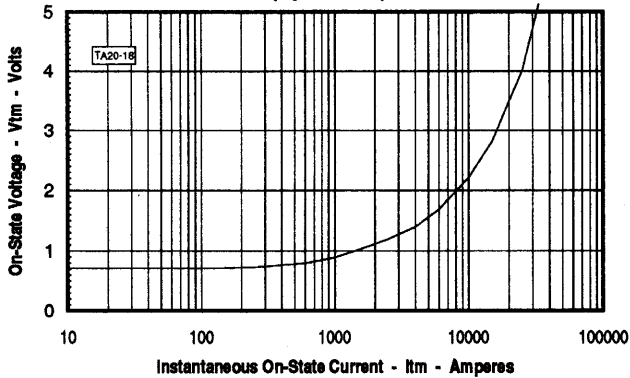

**Maximum Transient Thermal Impedance**  
 (Junction to Case)

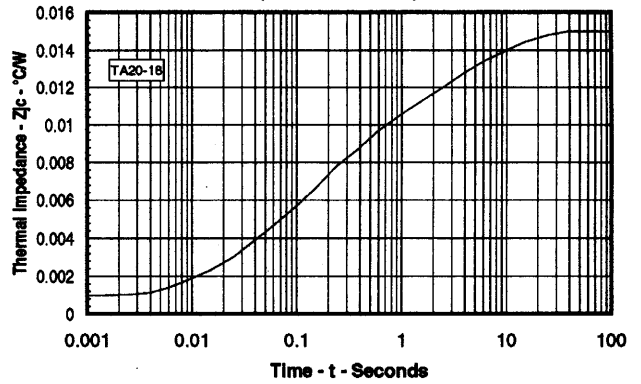

**Maximum On-State Power Dissipation**  
 (Sinusoidal Waveform)

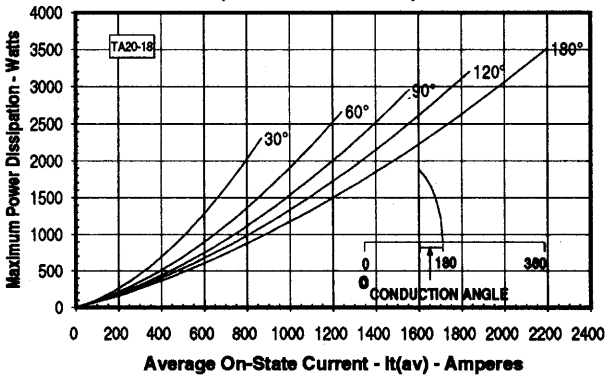

**Maximum Allowable Case Temperature**  
 (Sinusoidal Waveform)

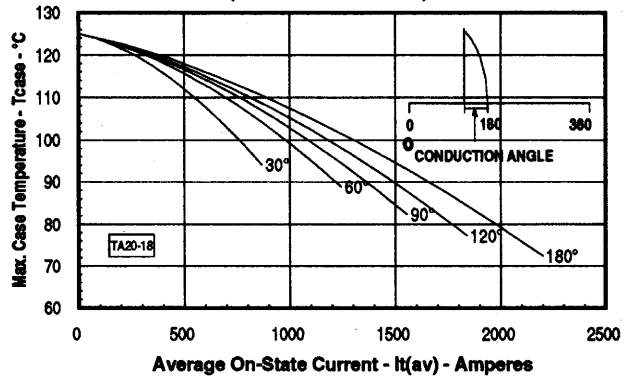

**Maximum On-State Power Dissipation**  
 (Rectangular Waveform)

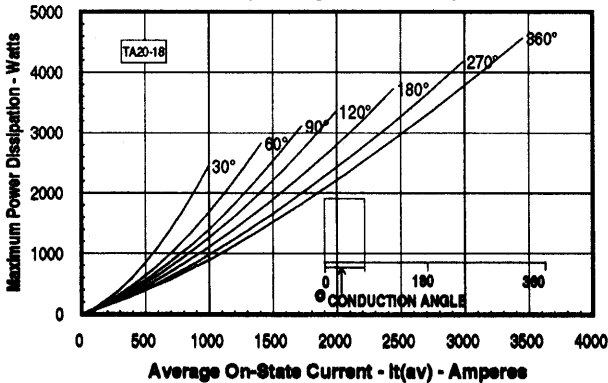

**Maximum Allowable Case Temperature**  
 (Rectangular Waveform)

