

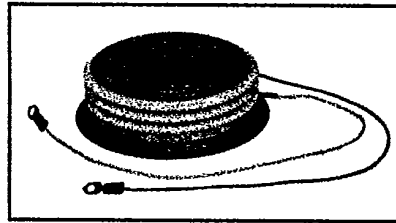

C783

Powerex, Inc. Hillis Street, Youngwood, Pennsylvania 15697 (412) 925-7272
 Powerex Europe, S.A., 428 Ave. G. Durand, BP107, 72003 LeMans, France (43) 72.75.15

Phase Control SCR
 1800 Amperes Avg
 8000-3700 Volts

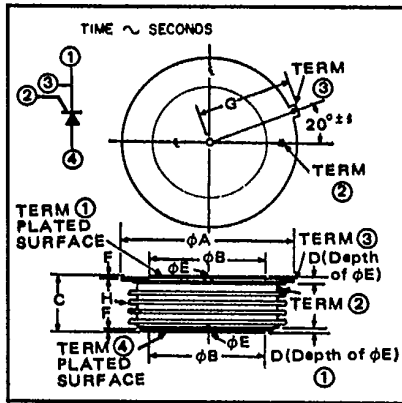

C783
Phase Control SCR
 1800 Amperes/3000-3700 Volts

C783
Outline Drawing

Dimensions	Inches		Millimeters	
	Min.	Max.	Min.	Max.
φA	—	4.350	—	110.49
φB	2.876	2.890	73.05	73.15
C	1.387	1.447	35.23	36.75
D	.080	—	2.03	—
φE	0.136	0.146	3.45	3.71
F	0.20	—	5.08	—
G	2.403	2.418	61.16	61.42
H	—	—	—	—

Description

Powerex Silicon Controlled Rectifiers (SCR) are designed for phase control applications. These are all-diffused, Press-Pak (Pow-R-Disc) devices employing the field-proven amplifying (di/namic) gate.

Features:

- Low On-State Voltage
- High di/dt
- High dv/dt
- Hermetic Packaging
- Excellent Surge and I²t Ratings

Applications:

- Power Supplies
- Battery Chargers
- Motor Control
- Light Dimmers
- VAR Generators

Ordering Information

Example: Select the complete six digit part number you desire from the table - i.e. C784CD is a 3400 Volt, 1800 Ampere Phase Control SCR.

Type	Voltage		Current
	V _{ORM} V _{RRM}	Code	
C783	3000	CP	1800
	3100	CA	
	3200	CB	
	3300	CC	
	3400	CD	
	3500	CE	
	3600	CM	
	3700	CS	



Powerex, Inc., Hillis Street, Youngwood, Pennsylvania 15697 (412) 925-7272

Powerex Europe, S.A., 428 Ave. G. Durand, BP107, 72003 LeMans, France (43) 72.75.15

C783

Phase Control SCR

1800 Amperes Avg/3000-3700 Volts

Absolute Maximum Ratings

	Symbol	C783	Units
RMS On-State Current	$I_{T(RMS)}$	2626	Amperes
Average On-State Current	$I_{T(av)}$	1800	Amperes
Peak One-Cycle Surge (Non-Repetitive) On-State Current (60Hz)	I_{TSM}	29,000	Amperes
Peak One-Cycle Surge (Non-Repetitive) On-State Current (50Hz)	I_{TSM}	27,000	Amperes
Critical Rate-of-Rise of On-State Current (Non-Repetitive)	di/dt	600	Amperes/ μ s
Critical Rate-of-Rise of On-State Current (Repetitive)	di/dt	100	Amperes/ μ s
I^2t (for Fusing), One Cycle at 60Hz	I^2t	3.5×10^6	A ² sec
Peak Gate Power Dissipation, 100 microseconds	P_{GM}	250	Watts
Average Gate Power Dissipation	$P_{G(av)}$	35	Watts
Storage Temperature	T_{STG}	-40 to 150	°C
Operating Temperature	T_J	-40 to 125	°C
Mounting Force [ⓐ]		9000 to 10,000	lb.
Mounting Force [ⓐ]		44 to 44.5	kN

[ⓐ] Consult recommended mounting procedures.



Powerex, Inc., Hillis Street, Youngwood, Pennsylvania 15697 (412) 925-7272

Powerex Europe, S.A., 428 Ave. G. Durand, BP107, 72003 LeMans, France (43) 72.75.15

C783

Phase Control SCR

1800 Amperes Avg/3000-3700 Volts

Electrical and Thermal Characteristics

Characteristics	Symbol	Test Conditions	C783	Units
Voltage—Blocking State Maximums				
Forward Leakage, Peak	I_{DRM}	$T_J = 125^\circ\text{C}$, $V_{DRM} = \text{Rated}$	150	mA
Reverse Leakage, Peak	I_{RRM}	$T_J = 125^\circ\text{C}$, $V_{RRM} = \text{Rated}$	150	mA
Current—Conducting State Maximums				
Peak On-State Voltage	V_{TM}	$T_J = 125^\circ\text{C}$, $I_{TM} = 2000\text{A}$	1.71	Volts
Switching				
Typical Turn-Off Time	t_q	$T_J = 125^\circ\text{C}$, $I_{TM} = 500\text{A}$ Commutating $di/dt = 25\text{A}/\mu\text{sec}$ Minimum reverse voltage, $V_R = 50\text{V}$ Reapplied $dv/dt = 20\text{V}/\mu\text{sec}$ to $0.8 V_{DRM}$	200	μsec
Typical Delay Time	t_d	$T_J = 125^\circ\text{C}$, $V_D = 1800\text{V}$	3	μsec
Min. Critical dv/dt exponential to V_{DRM}	dv/dt	$T_J = 125^\circ\text{C}$, $V_D = .8V_{DRM}$	500	$\text{V}/\mu\text{sec}$
Thermal				
Maximum Thermal Resistance, [ⓐ] double sided cooling				
Junction to Case	$R_{\theta JC}$.012	$^\circ\text{C}/\text{Watt}$
Case to Sink, Lubricated	$R_{\theta CS}$.002	$^\circ\text{C}/\text{Watt}$
Gate—Maximum Parameters				
Gate Current to Trigger	I_{GT}	$T_J = 25^\circ\text{C}$, $V_D = 12\text{Vdc}$	250	mA
Gate Voltage to Trigger	V_{GT}	$T_J = 25^\circ\text{C}$, $V_D = 12\text{Vdc}$	4.5	Volts
Non-Triggering Gate Voltage	V_{GDM}	$T_J = 125^\circ\text{C}$, $V_D = 1800\text{V}$.8	Volts
Peak Forward Gate Current	I_{GTM}		20	Amperes
Peak Reverse Gate Voltage	V_{GRM}		20	Volts

[ⓐ] Consult recommended mounting procedures.



Powerex, Inc., Hills Street, Youngwood, Pennsylvania 15697 (412) 925-7272

Powerex Europe, S.A., 428 Ave. G. Durand, BP107, 72003 LeMans, France (43) 72.75.15

C783

Phase Control SCR

1800 Amperes Avg/3000-3700 Volts

