

MC14049B, MC14050B

Hex Buffer

The MC14049B Hex Inverter/Buffer and MC14050B Noninverting Hex Buffer are constructed with MOS P-Channel and N-Channel enhancement mode devices in a single monolithic structure. These complementary MOS devices find primary use where low power dissipation and/or high noise immunity is desired. These devices provide logic level conversion using only one supply voltage, V_{DD} .

The input-signal high level (V_{IH}) can exceed the V_{DD} supply voltage for logic level conversions. Two TTL/DTL loads can be driven when the devices are used as a CMOS-to-TTL/DTL converter ($V_{DD} = 5.0\text{ V}$, $V_{OL} \leq 0.4\text{ V}$, $I_{OL} \geq 3.2\text{ mA}$).

Note that pins 13 and 16 are not connected internally on these devices; consequently connections to these terminals will not affect circuit operation.

Features

- High Source and Sink Currents
- High-to-Low Level Converter
- Supply Voltage Range = 3.0 V to 18 V
- V_{IN} can exceed V_{DD}
- Meets JEDEC B Specifications
- Improved ESD Protection On All Inputs
- Pb-Free Packages are Available*

MAXIMUM RATINGS (Voltages Referenced to V_{SS})

Symbol	Parameter	Value	Unit
V_{DD}	DC Supply Voltage Range	-0.5 to +18.0	V
V_{in}	Input Voltage Range (DC or Transient)	-0.5 to +18.0	V
V_{out}	Output Voltage Range (DC or Transient)	-0.5 to $V_{DD} + 0.5$	V
I_{in}	Input Current (DC or Transient) per Pin	± 10	mA
I_{out}	Output Current (DC or Transient) per Pin	± 45	mA
P_D	Power Dissipation, per Package (Note 1) (Plastic) (SOIC)	825 740	mW
T_A	Ambient Temperature Range	-55 to +125	$^{\circ}\text{C}$
T_{stg}	Storage Temperature Range	-65 to +150	$^{\circ}\text{C}$
T_L	Lead Temperature (8-Second Soldering)	260	$^{\circ}\text{C}$

1. Temperature Derating: See Figure 3.

This device contains protection circuitry to protect the inputs against damage due to high static voltages or electric fields referenced to the V_{SS} pin only. Extra precautions must be taken to avoid applications of any voltage higher than the maximum rated voltages to this high-impedance circuit. For proper operation, the ranges $V_{SS} \leq V_{in} \leq 18\text{ V}$ and $V_{SS} \leq V_{out} \leq V_{DD}$ are recommended.

Unused inputs must always be tied to an appropriate logic voltage level (e.g., either V_{SS} or V_{DD}). Unused outputs must be left open.

*For additional information on our Pb-Free strategy and soldering details, please download the ON Semiconductor Soldering and Mounting Techniques Reference Manual, SOLDERRM/D.



ON Semiconductor®

<http://onsemi.com>

MARKING DIAGRAMS

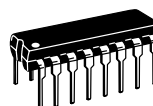

PDIP-16
P SUFFIX
CASE 648

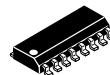
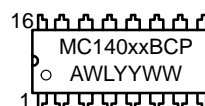

SOIC-16
D SUFFIX
CASE 751B



TSSOP-16
DT SUFFIX
CASE 948F

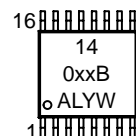

SOEIAJ-16
F SUFFIX
CASE 966

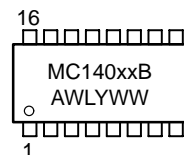

xx = Specific Device Code
A = Assembly Location
WL, L = Wafer Lot
YY, Y = Year
WW, W = Work Week

ORDERING INFORMATION

See detailed ordering and shipping information in the package dimensions section on page 2 of this data sheet.

MC14049B, MC14050B

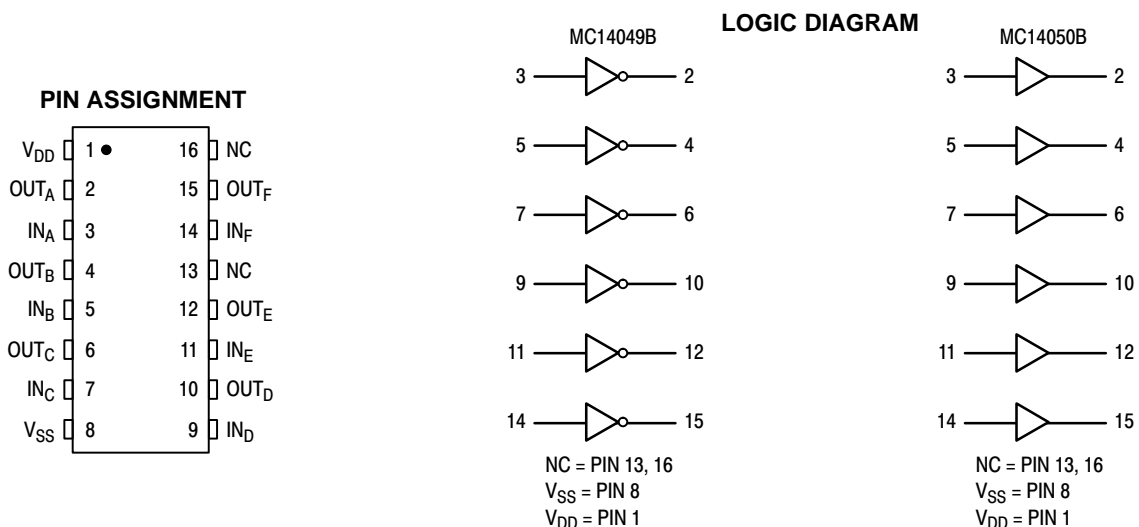

ORDERING INFORMATION

Device	Package	Shipping [†]
MC14049BCP	PDIP-16	500 Units / Rail
MC14049BCPG	PDIP-16 (Pb-Free)	500 Units / Rail
MC14049BD	SOIC-16	48 Units / Rail
MC14049BDG	SOIC-16 (Pb-Free)	48 Units / Rail
MC14049BDR2	SOIC-16	2500 Units / Tape & Reel
MC14049BDR2G	SOIC-16 (Pb-Free)	2500 Units / Tape & Reel
MC14049BFEL	SOEIAJ-16	2000 Units / Tape & Reel
MC14050BCP	PDIP-16	500 Units / Rail
MC14050BCPG	PDIP-16 (Pb-Free)	500 Units / Rail
MC14050BD	SOIC-16	48 Units / Rail
MC14050BDR2	SOIC-16	2500 Units / Tape & Reel
MC14050BDR2G	SOIC-16 (Pb-Free)	2500 Units / Tape & Reel
MC14050BDT	TSSOP-16*	96 Units / Rail
MC14050BDTR2	TSSOP-16*	2500 Units / Tape & Reel
MC14050BFEL	SOEIAJ-16	2000 Units / Tape & Reel
MC14050BFELG	SOEIAJ-16 (Pb-Free)	2000 Units / Tape & Reel

[†]For information on tape and reel specifications, including part orientation and tape sizes, please refer to our Tape and Reel Packaging Specifications Brochure, BRD8011/D.

*This package is inherently Pb-Free.

MC14049B, MC14050B

ELECTRICAL CHARACTERISTICS (Voltages Referenced to V_{SS})

Characteristic	Symbol	V_{DD} Vdc	- 55°C		+ 25°C			+ 125°C		Unit	
			Min	Max	Min	Typ (Note 2)	Max	Min	Max		
Output Voltage $V_{in} = V_{DD}$ $V_{in} = 0$	"0" Level V_{OL}	5.0	-	0.05	-	0	0.05	-	0.05	Vdc	
		10	-	0.05	-	0	0.05	-	0.05		
		15	-	0.05	-	0	0.05	-	0.05		
	"1" Level V_{OH}	5.0	4.95	-	4.95	5.0	-	4.95	-		Vdc
		10	9.95	-	9.95	10	-	9.95	-		
		15	14.95	-	14.95	15	-	14.95	-		
Input Voltage ($V_O = 4.5$ Vdc) ($V_O = 9.0$ Vdc) ($V_O = 13.5$ Vdc) ($V_O = 0.5$ Vdc) ($V_O = 1.0$ Vdc) ($V_O = 1.5$ Vdc)	"0" Level V_{IL}	5.0	-	1.5	-	2.25	1.5	-	1.5	Vdc	
		10	-	3.0	-	4.50	3.0	-	3.0		
		15	-	4.0	-	6.75	4.0	-	4.0		
	"1" Level V_{IH}	5.0	3.5	-	3.5	2.75	-	3.5	-		Vdc
		10	7.0	-	7.0	5.50	-	7.0	-		
		15	11	-	11	8.25	-	11	-		
Output Drive Current ($V_{OH} = 2.5$ Vdc) ($V_{OH} = 9.5$ Vdc) ($V_{OH} = 13.5$ Vdc) ($V_{OL} = 0.4$ Vdc) ($V_{OL} = 0.5$ Vdc) ($V_{OL} = 1.5$ Vdc)	Source I_{OH}	5.0	-1.6	-	-1.25	-2.5	-	-1.0	-	mAdc	
		10	-1.6	-	-1.30	-2.6	-	-1.0	-		
		15	-4.7	-	-3.75	-10	-	-3.0	-		
	Sink I_{OL}	5.0	3.75	-	3.2	6.0	-	2.6	-		mAdc
		10	10	-	8.0	16	-	6.6	-		
		15	30	-	24	40	-	19	-		
Input Current	I_{in}	15	-	± 0.1	-	± 0.00001	± 0.1	-	± 1.0	μ Adc	
Input Capacitance ($V_{in} = 0$)	C_{in}	-	-	-	-	10	20	-	-	pF	
Quiescent Current (Per Package)	I_{DD}	5.0 10 15	- - -	1.0 2.0 4.0	- - -	0.002 0.004 0.006	1.0 2.0 4.0	- - -	30 60 120	μ Adc	
Total Supply Current (Notes 3 & 4) (Dynamic plus Quiescent, per package) ($C_L = 50$ pF on all outputs, all buffers switching)	I_T	5.0 10 15	$I_T = (1.8 \mu\text{A/kHz}) f + I_{DD}$ $I_T = (3.5 \mu\text{A/kHz}) f + I_{DD}$ $I_T = (5.3 \mu\text{A/kHz}) f + I_{DD}$							μ Adc	

2. Data labelled "Typ" is not to be used for design purposes but is intended as an indication of the IC's potential performance.

3. The formulas given are for the typical characteristics only at + 25°C

4. To calculate total supply current at loads other than 50 pF:

$$I_T(C_L) = I_T(50 \text{ pF}) + (C_L - 50) \text{ Vfk}$$

Where: I_T is in μA (per Package), C_L in pF, $V = (V_{DD} - V_{SS})$ in volts, f in kHz is input frequency and $k = 0.002$.

MC14049B, MC14050B

AC SWITCHING CHARACTERISTICS (Note 5) ($C_L = 50 \text{ pF}$, $T_A = +25^\circ\text{C}$)

Characteristic	Symbol	V_{DD} Vdc	Min	Typ (Note 6)	Max	Unit
Output Rise Time $t_{TLH} = (0.7 \text{ ns/pF}) C_L + 65 \text{ ns}$ $t_{TLH} = (0.25 \text{ ns/pF}) C_L + 37.5 \text{ ns}$ $t_{TLH} = (0.2 \text{ ns/pF}) C_L + 30 \text{ ns}$	t_{TLH}	5.0 10 15	- - -	100 50 40	160 80 60	ns
Output Fall Time $t_{THL} = (0.2 \text{ ns/pF}) C_L + 30 \text{ ns}$ $t_{THL} = (0.06 \text{ ns/pF}) C_L + 17 \text{ ns}$ $t_{THL} = (0.04 \text{ ns/pF}) C_L + 13 \text{ ns}$	t_{THL}	5.0 10 15	- - -	40 20 15	60 40 30	ns
Propagation Delay Time $t_{PLH} = (0.33 \text{ ns/pF}) C_L + 63.5 \text{ ns}$ $t_{PLH} = (0.19 \text{ ns/pF}) C_L + 30.5 \text{ ns}$ $t_{PLH} = (0.06 \text{ ns/pF}) C_L + 27 \text{ ns}$	t_{PLH}	5.0 10 15	- - -	80 40 30	140 80 60	ns
Propagation Delay Time $t_{PHL} = (0.2 \text{ ns/pF}) C_L + 30 \text{ ns}$ $t_{PHL} = (0.1 \text{ ns/pF}) C_L + 15 \text{ ns}$ $t_{PHL} = (0.05 \text{ ns/pF}) C_L + 12.5 \text{ ns}$	t_{PHL}	5.0 10 15	- - -	40 20 15	80 40 30	ns

5. The formulas given are for the typical characteristics only at 25°C .

6. Data labeled "Typ" is not to be used for design purposes but is intended as an indication of the IC's potential performance.

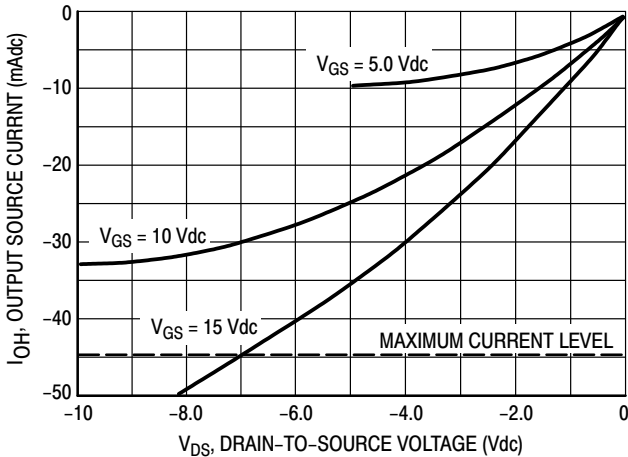
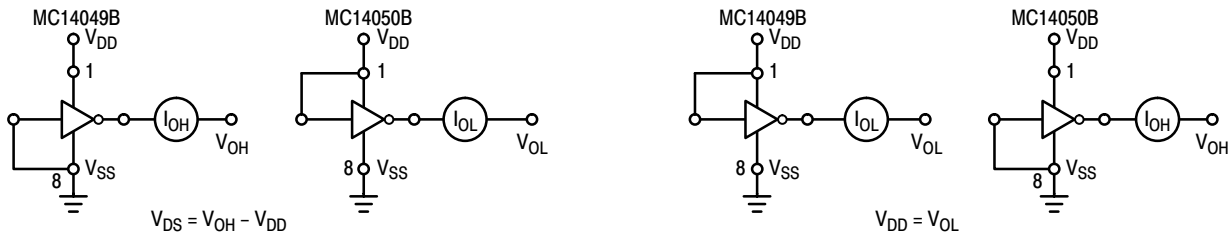

Figure 1. Typical Output Source Characteristics

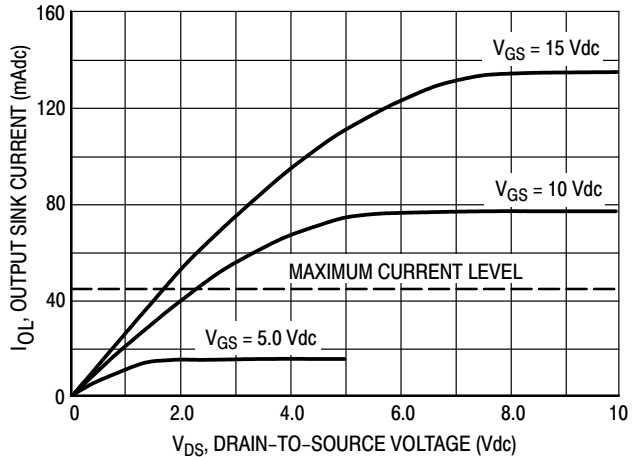

Figure 2. Typical Output Sink Characteristics

MC14049B, MC14050B

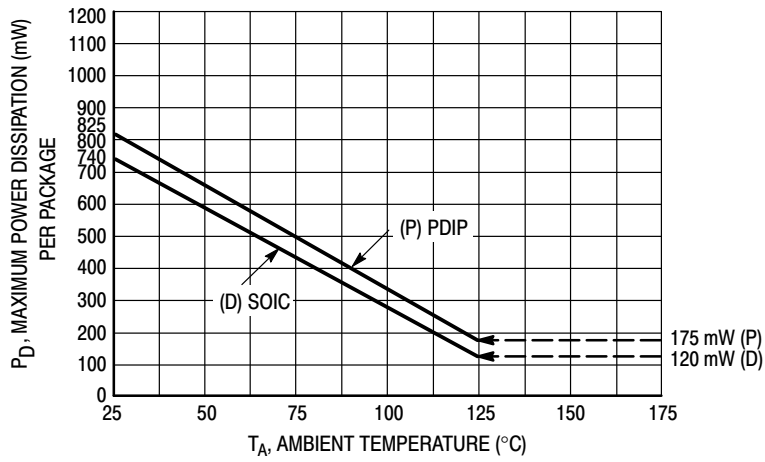

Figure 3. Ambient Temperature Power Derating

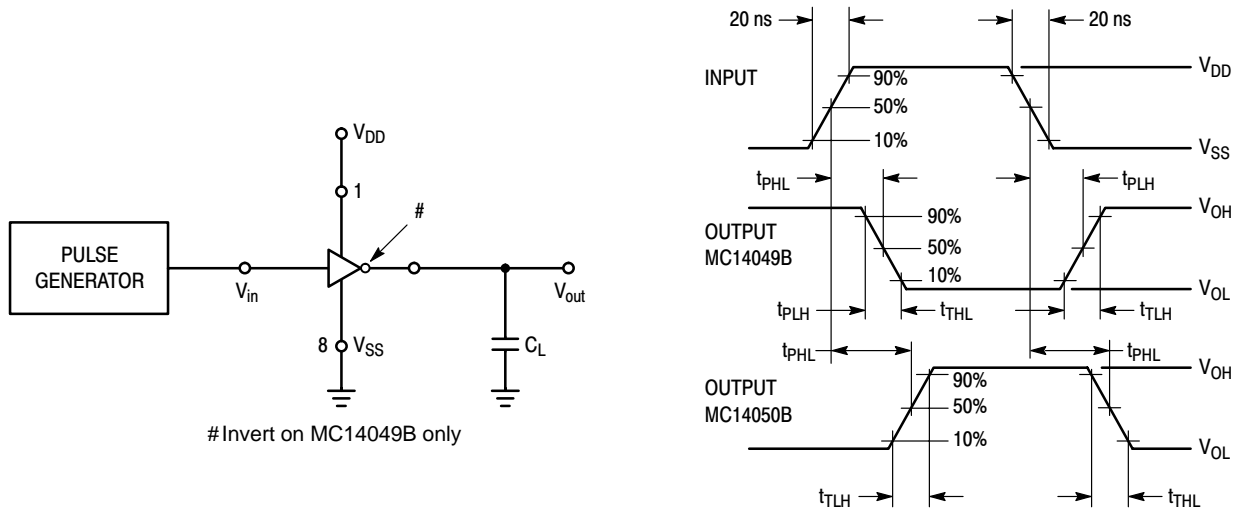
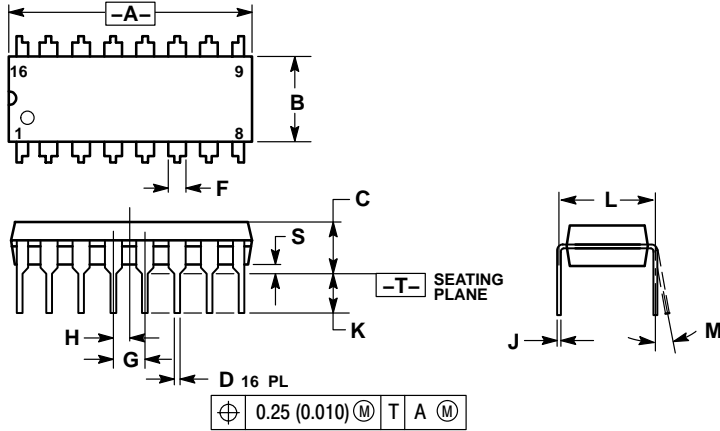

Figure 4. Switching Time Test Circuit and Waveforms

MC14049B, MC14050B

PACKAGE DIMENSIONS

PDIP-16
P SUFFIX
PLASTIC DIP PACKAGE
CASE 648-08
ISSUE T



NOTES:

1. DIMENSIONING AND TOLERANCING PER ANSI Y14.5M, 1982.
2. CONTROLLING DIMENSION: INCH.
3. DIMENSION L TO CENTER OF LEADS WHEN FORMED PARALLEL.
4. DIMENSION B DOES NOT INCLUDE MOLD FLASH.
5. ROUNDED CORNERS OPTIONAL.

DIM	INCHES		MILLIMETERS	
	MIN	MAX	MIN	MAX
A	0.740	0.770	18.80	19.55
B	0.250	0.270	6.35	6.85
C	0.145	0.175	3.69	4.44
D	0.015	0.021	0.39	0.53
F	0.040	0.70	1.02	1.77
G	0.100 BSC		2.54 BSC	
H	0.050 BSC		1.27 BSC	
J	0.008	0.015	0.21	0.38
K	0.110	0.130	2.80	3.30
L	0.295	0.305	7.50	7.74
M	0°	10°	0°	10°
S	0.020	0.040	0.51	1.01

SOIC-16
D SUFFIX
PLASTIC SOIC PACKAGE
CASE 751B-05
ISSUE J

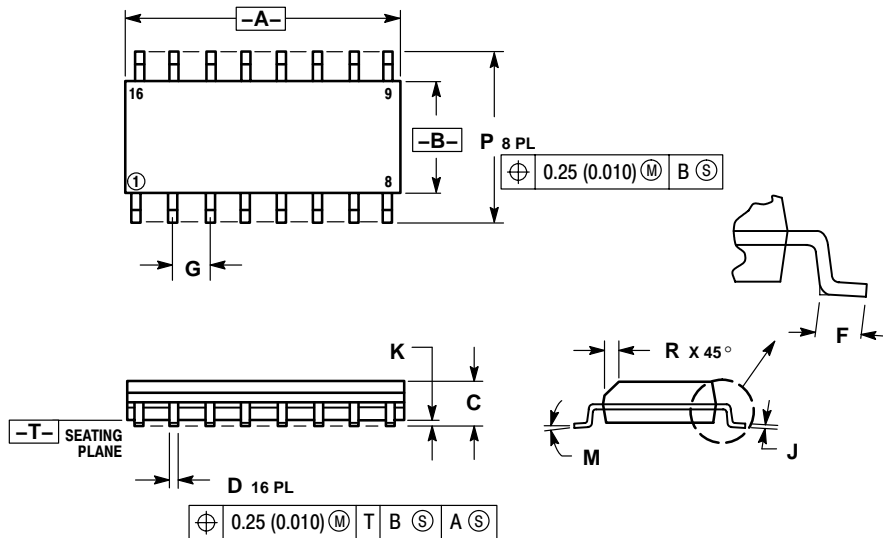

NOTES:

1. DIMENSIONING AND TOLERANCING PER ANSI Y14.5M, 1982.
2. CONTROLLING DIMENSION: MILLIMETER.
3. DIMENSIONS A AND B DO NOT INCLUDE MOLD PROTRUSION.
4. MAXIMUM MOLD PROTRUSION 0.15 (0.006) PER SIDE.
5. DIMENSION D DOES NOT INCLUDE DAMBAR PROTRUSION. ALLOWABLE DAMBAR PROTRUSION SHALL BE 0.127 (0.005) TOTAL IN EXCESS OF THE D DIMENSION AT MAXIMUM MATERIAL CONDITION.

DIM	MILLIMETERS		INCHES	
	MIN	MAX	MIN	MAX
A	9.80	10.00	0.386	0.393
B	3.80	4.00	0.150	0.157
C	1.35	1.75	0.054	0.068
D	0.35	0.49	0.014	0.019
F	0.40	1.25	0.016	0.049
G	1.27 BSC		0.050 BSC	
J	0.19	0.25	0.008	0.009
K	0.10	0.25	0.004	0.009
M	0°	7°	0°	7°
P	5.80	6.20	0.229	0.244
R	0.25	0.50	0.010	0.019

MC14049B, MC14050B

PACKAGE DIMENSIONS

TSSOP-16
DT SUFFIX
PLASTIC TSSOP PACKAGE
CASE 948F-01
ISSUE A

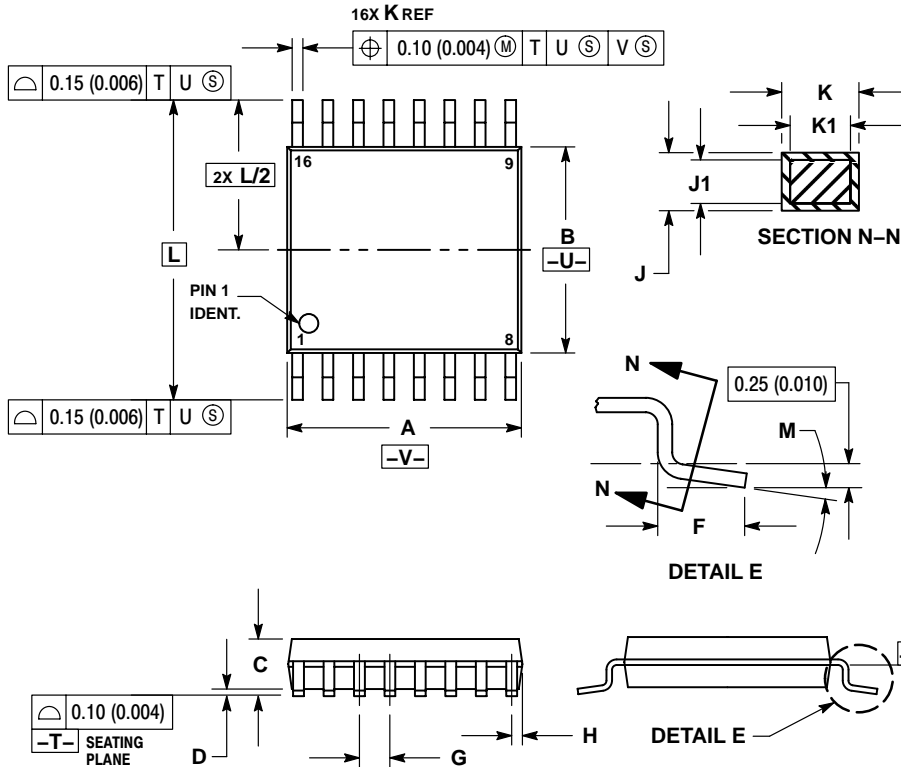

NOTES:

1. DIMENSIONING AND TOLERANCING PER ANSI Y14.5M, 1982.
2. CONTROLLING DIMENSION: MILLIMETER.
3. DIMENSION A DOES NOT INCLUDE MOLD FLASH, PROTRUSIONS OR GATE BURRS. MOLD FLASH OR GATE BURRS SHALL NOT EXCEED 0.15 (0.006) PER SIDE.
4. DIMENSION B DOES NOT INCLUDE INTERLEAD FLASH OR PROTRUSION. INTERLEAD FLASH OR PROTRUSION SHALL NOT EXCEED 0.25 (0.010) PER SIDE.
5. DIMENSION K DOES NOT INCLUDE DAMBAR PROTRUSION. ALLOWABLE DAMBAR PROTRUSION SHALL BE 0.08 (0.003) TOTAL IN EXCESS OF THE K DIMENSION AT MAXIMUM MATERIAL CONDITION.
6. TERMINAL NUMBERS ARE SHOWN FOR REFERENCE ONLY.
7. DIMENSION A AND B ARE TO BE DETERMINED AT DATUM PLANE -W-.

DIM	MILLIMETERS		INCHES	
	MIN	MAX	MIN	MAX
A	4.90	5.10	0.193	0.200
B	4.30	4.50	0.169	0.177
C	---	1.20	---	0.047
D	0.05	0.15	0.002	0.006
F	0.50	0.75	0.020	0.030
G	0.65 BSC		0.026 BSC	
H	0.18	0.28	0.007	0.011
J	0.09	0.20	0.004	0.008
J1	0.09	0.16	0.004	0.006
K	0.19	0.30	0.007	0.012
K1	0.19	0.25	0.007	0.010
L	6.40 BSC		0.252 BSC	
M	0°	8°	0°	8°

MC14049B, MC14050B

PACKAGE DIMENSIONS

SOEIAJ-16 F SUFFIX PLASTIC EIAJ SOIC PACKAGE CASE 966-01 ISSUE O

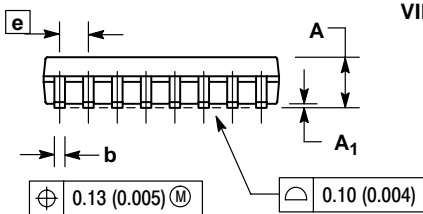
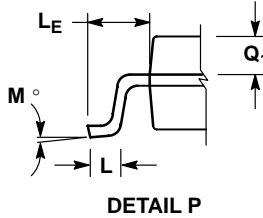
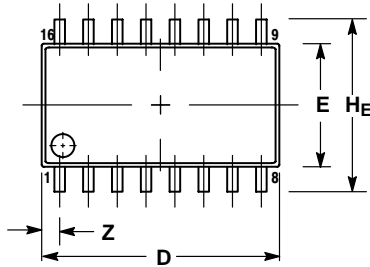

NOTES:

1. DIMENSIONING AND TOLERANCING PER ANSI Y14.5M, 1982.
2. CONTROLLING DIMENSION: MILLIMETER.
3. DIMENSIONS D AND E DO NOT INCLUDE MOLD FLASH OR PROTRUSIONS AND ARE MEASURED AT THE PARTING LINE. MOLD FLASH OR PROTRUSIONS SHALL NOT EXCEED 0.15 (0.006) PER SIDE.
4. TERMINAL NUMBERS ARE SHOWN FOR REFERENCE ONLY.
5. THE LEAD WIDTH DIMENSION (b) DOES NOT INCLUDE DAMBAR PROTRUSION. ALLOWABLE DAMBAR PROTRUSION SHALL BE 0.08 (0.003) TOTAL IN EXCESS OF THE LEAD WIDTH DIMENSION AT MAXIMUM MATERIAL CONDITION. DAMBAR CANNOT BE LOCATED ON THE LOWER RADIUS OR THE FOOT. MINIMUM SPACE BETWEEN PROTRUSIONS AND ADJACENT LEAD TO BE 0.46 (0.018).

DIM	MILLIMETERS		INCHES	
	MIN	MAX	MIN	MAX
A	---	2.05	---	0.081
A ₁	0.05	0.20	0.002	0.008
b	0.35	0.50	0.014	0.020
c	0.18	0.27	0.007	0.011
D	9.90	10.50	0.390	0.413
E	5.10	5.45	0.201	0.215
e	1.27 BSC		0.050 BSC	
H _E	7.40	8.20	0.291	0.323
L	0.50	0.85	0.020	0.033
L _E	1.10	1.50	0.043	0.059
M	0°	10°	0°	10°
Q ₁	0.70	0.90	0.028	0.035
Z	---	0.78	---	0.031

ON Semiconductor and  are registered trademarks of Semiconductor Components Industries, LLC (SCILLC). SCILLC reserves the right to make changes without further notice to any products herein. SCILLC makes no warranty, representation or guarantee regarding the suitability of its products for any particular purpose, nor does SCILLC assume any liability arising out of the application or use of any product or circuit, and specifically disclaims any and all liability, including without limitation special, consequential or incidental damages. "Typical" parameters which may be provided in SCILLC data sheets and/or specifications can and do vary in different applications and actual performance may vary over time. All operating parameters, including "Typicals" must be validated for each customer application by customer's technical experts. SCILLC does not convey any license under its patent rights nor the rights of others. SCILLC products are not designed, intended, or authorized for use as components in systems intended for surgical implant into the body, or other applications intended to support or sustain life, or for any other application in which the failure of the SCILLC product could create a situation where personal injury or death may occur. Should Buyer purchase or use SCILLC products for any such unintended or unauthorized application, Buyer shall indemnify and hold SCILLC and its officers, employees, subsidiaries, affiliates, and distributors harmless against all claims, costs, damages, and expenses, and reasonable attorney fees arising out of, directly or indirectly, any claim of personal injury or death associated with such unintended or unauthorized use, even if such claim alleges that SCILLC was negligent regarding the design or manufacture of the part. SCILLC is an Equal Opportunity/Affirmative Action Employer. This literature is subject to all applicable copyright laws and is not for resale in any manner.

PUBLICATION ORDERING INFORMATION

LITERATURE FULFILLMENT:

Literature Distribution Center for ON Semiconductor
P.O. Box 61312, Phoenix, Arizona 85082-1312 USA
Phone: 480-829-7710 or 800-344-3860 Toll Free USA/Canada
Fax: 480-829-7709 or 800-344-3867 Toll Free USA/Canada
Email: orderlit@onsemi.com

N. American Technical Support: 800-282-9855 Toll Free USA/Canada

Japan: ON Semiconductor, Japan Customer Focus Center
2-9-1 Kamimeguro, Meguro-ku, Tokyo, Japan 153-0051
Phone: 81-3-5773-3850

ON Semiconductor Website: <http://onsemi.com>

Order Literature: <http://www.onsemi.com/litorder>

For additional information, please contact your local Sales Representative.