

General Description

The DS1090 is a low-cost, dithered oscillator intended to be used as an external clock for switched-mode power supplies and other low-frequency applications. The dithering or sweeping function reduces peak-radiated emissions from the power supply at its fundamental frequency, as well as harmonic frequencies. The device consists of a resistor-programmed master oscillator, factory-programmed clock prescaler, and a pin-programmed dither circuit. These features allow the DS1090 to be used in applications where a spread-spectrum clock is desired to reduce radiated emissions. A combination of factory-set prescalers and external resistor allows for output frequencies ranging from 125kHz to 8MHz. Both dither frequency and dither percentage are set using control pins.

Applications

- Switched-Mode Power Supplies
- Servers
- Printers
- Embedded Microcontrollers
- Industrial Controls

Typical Operating Circuit

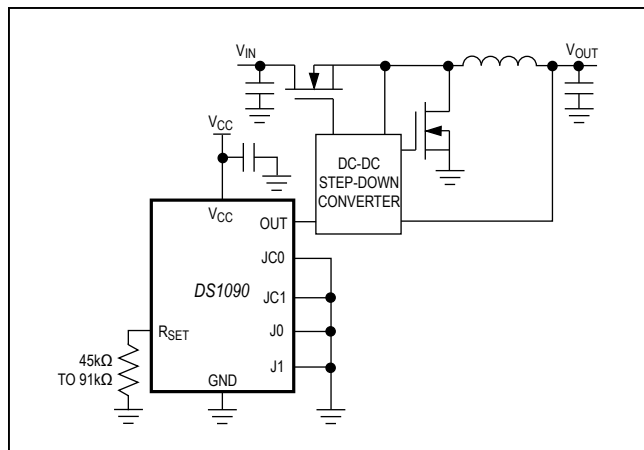

EconOscillator is a trademark of Maxim Integrated Products, Inc.

Features

- Low-Cost, Spread-Spectrum EconOscillator™
- Simple User Programming
- Output Frequency Programmable from 125kHz to 8MHz
- Dither Percentage Programmable from 0% to 8%
- Dither Rate Programmable ($f_{MOSC}/512, 1024, 2048, \text{ or } 4096$)
- 3.0V to 5.5V Single-Supply Operation
- CMOS/TTL-Compatible Output
- Operating Temperature Range: -40°C to $+85^{\circ}\text{C}$

Ordering Information

PART	OUTPUT FREQUENCY RANGE	PRESCALER	PIN-PACKAGE
DS1090U-1+	4MHz to 8MHz	1	8 μ SOP
DS1090U-2+	2MHz to 4MHz	2	8 μ SOP
DS1090U-4+	1MHz to 2MHz	4	8 μ SOP
DS1090U-8+	500kHz to 1MHz	8	8 μ SOP
DS1090U-16+	250kHz to 500kHz	16	8 μ SOP
DS1090U-32+	125kHz to 250kHz	32	8 μ SOP

Add "T" for Tape & Reel orders.

Pin Configuration

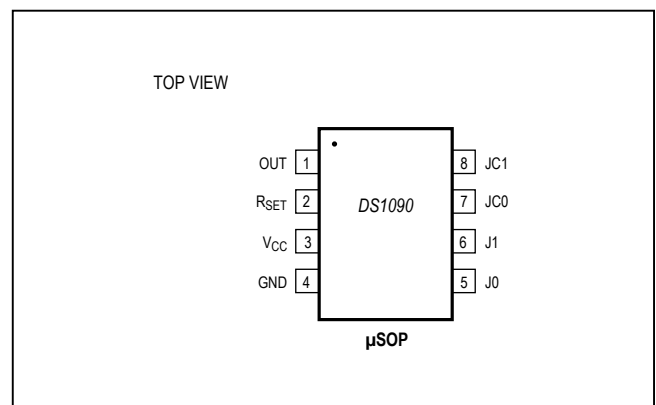

Absolute Maximum Ratings

Voltage Range on V_{CC} Relative to Ground -0.5V to +6.0V
 Voltage Range on Input Pins
 Relative to Ground..... -0.5V to ($V_{CC} + 0.5V$),
 not to exceed 6.0V

Operating Temperature Range..... -40°C to +85°C
 Storage Temperature Range..... -55°C to +125°C
 Soldering Temperature See IPC/JEDEC
 J-STD-020A Specification

Stresses beyond those listed under "Absolute Maximum Ratings" may cause permanent damage to the device. These are stress ratings only, and functional operation of the device at these or any other conditions beyond those indicated in the operational sections of the specifications is not implied. Exposure to absolute maximum rating conditions for extended periods may affect device reliability.

Recommended DC Operating Conditions

($T_A = -40^\circ\text{C}$ to $+85^\circ\text{C}$)

PARAMETER	SYMBOL	CONDITIONS	MIN	TYP	MAX	UNITS
Supply Voltage	V_{CC}	(Note 1)	3.0		5.5	V
Input Logic 1 (J0, J1, JC0, JC1)	V_{IH}		0.7 x V_{CC}		$V_{CC} + 0.3$	V
Input Logic 0 (J0, J1, JC0, JC1)	V_{IL}		-0.3		+0.3 x V_{CC}	V

DC Electrical Characteristics

($V_{CC} = +3.0V$ to $+5.5V$, $T_A = -40^\circ\text{C}$ to $+85^\circ\text{C}$, unless otherwise noted.)

PARAMETER	SYMBOL	CONDITIONS	MIN	TYP	MAX	UNITS
Supply Current	I_{CC}	$C_L = 15\text{pF}$, $V_{CC} = 3.3V$, $R_{SET} = 40\text{k}\Omega$		1.4		mA
		$C_L = 15\text{pF}$, $V_{CC} = 5.5V$, $R_{SET} = 40\text{k}\Omega$		1.7	3	
High-Level Output Voltage (OUT)	V_{OH}	$I_{OH} = -4\text{mA}$ $V_{CC} = \text{min}$	2.4			V
Low-Level Output Voltage (OUT)	V_{OL}	$I_{OL} = 4\text{mA}$			0.4	V
High-Level Input Current (J0, J1, JC0, JC1)	I_{IH}	$V_{IH} = V_{CC}$			+1.0	μA
Low-Level Input Current (J0, J1, JC0, JC1)	I_{IL}	$V_{IL} = 0V$	-1.0			μA
Resistor Current	I_{RES}	$V_{CC} = \text{max}$			150	μA

AC Electrical Characteristics

($V_{CC} = +3.0V$ to $+5.5V$, $T_A = -40^\circ C$ to $+85^\circ C$, unless otherwise noted.)

PARAMETER	SYMBOL	CONDITIONS	MIN	TYP	MAX	UNITS
Internal Master Oscillator Frequency	f_{MOSC}		4.0		8.0	MHz
Output Frequency Tolerance	Δf_{OUT}	$V_{CC} = 3.3V$, $T_A = +25^\circ C$	-3.0		+3.0	%
Voltage Frequency Variation	Δf_{OUT}	$T_A = +25^\circ C$, $R_{SET} = 60k\Omega$, $V_{CC} = 3.0V$ to $3.6V$ (Notes 2, 3)	-0.5		+0.5	%
		$T_A = +25^\circ C$, $R_{SET} = 60k\Omega$, $V_{CC} = 4.5V$ to $5.5V$ (Notes 2, 3)	-1.25		+1.25	
Temperature Frequency Variation	Δf_{OUT}	$V_{CC} = 3.3V$ (Notes 2, 3, 4)	-2.0		+2.0	%
Peak-to-Peak Dither (3σ) (Note 5)		$J0 = GND$, $J1 = GND$		0		%
		$J0 = V_{CC}$, $J1 = GND$		2		
		$J0 = GND$, $J1 = V_{CC}$		4		
		$J0 = V_{CC}$, $J1 = V_{CC}$		8		
Power-Up Time	$t_{POR} + t_{STAB}$	(Note 6)		0.1	0.5	ms
Load Capacitance	C_L	(Note 7)			30	pF
Output Duty Cycle		4MHz to 8MHz, $T_A = +25^\circ C$ (Note 3)	45		55	%
		<4MHz (Note 4)		50		
Output Rise/Fall Time	t_R, t_F	$C_L = 15pF$			20	ns

Note 1: All voltages referenced to ground.

Note 2: This is the change observed in output frequency due to changes in temperature or voltage.

Note 3: See the *Typical Operating Characteristics* section.

Note 4: Parameter is guaranteed by design and is not production tested.

Note 5: This is a percentage of the output period. Parameter is characterized but not production tested. This can be varied from 0% to 8%.

Note 6: This indicates the time between power-up and the outputs becoming active. An on-chip delay is intentionally introduced to allow the oscillator to stabilize. t_{STAB} is equivalent to ~500 clock cycles and is dependent upon the programmed output frequency.

Note 7: Output voltage swings can be impaired at high frequencies combined with high output loading.

Typical Operating Characteristics

($V_{CC} = +3.3V$, $T_A = +25^\circ C$, unless otherwise noted.)

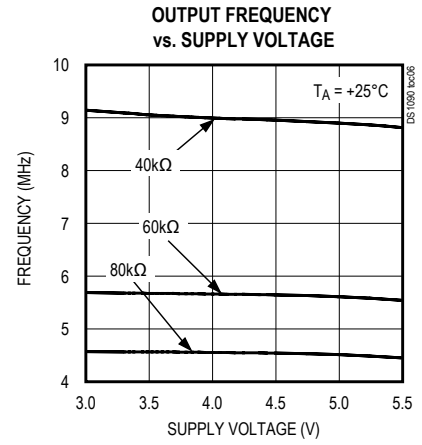
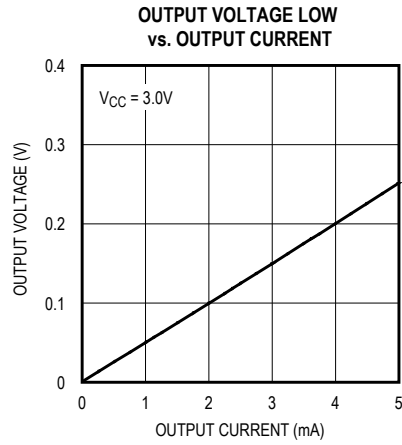
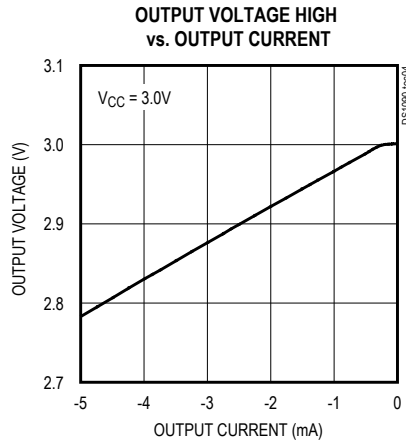
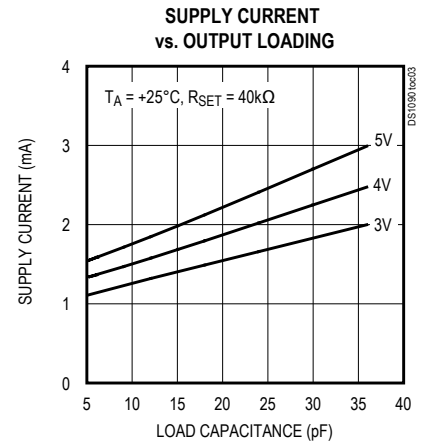
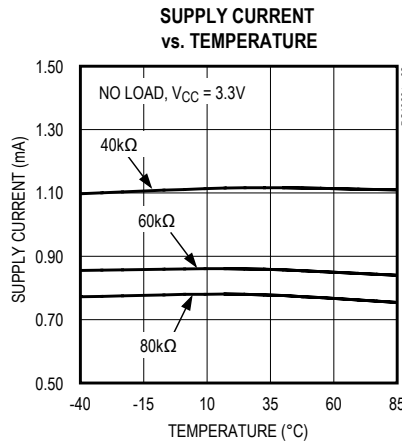
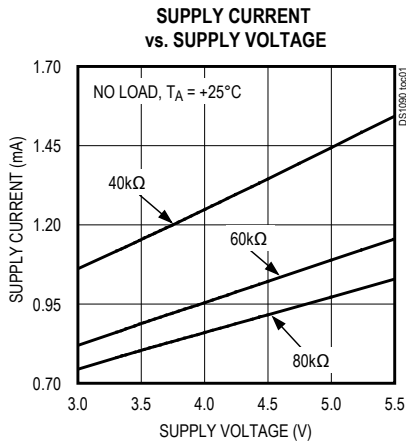

Typical Operating Characteristics (continued)

($V_{CC} = +3.3V$, $T_A = +25^\circ C$, unless otherwise noted.)

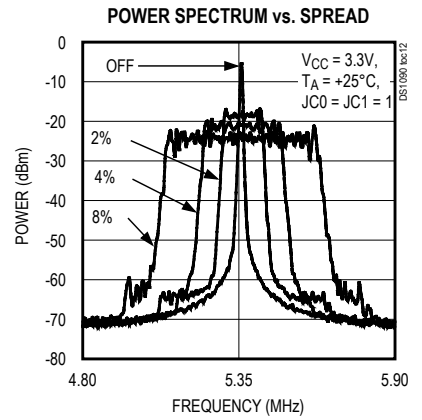
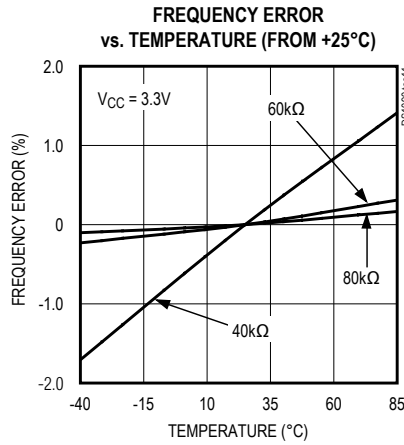
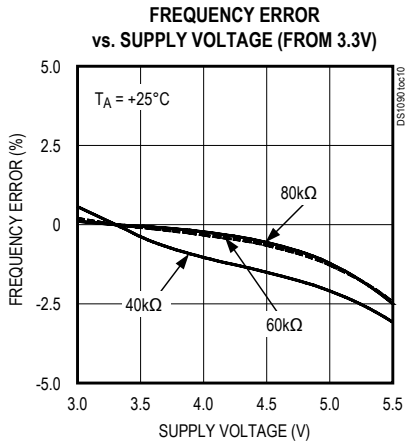
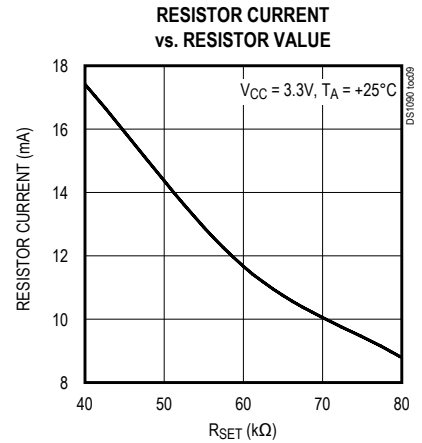
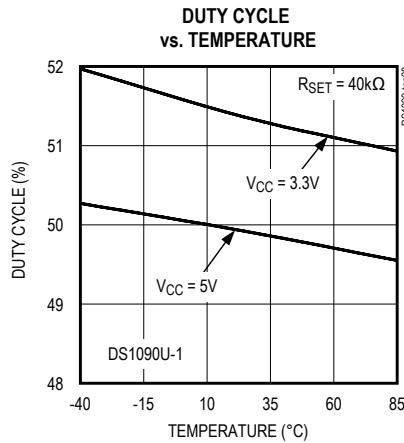
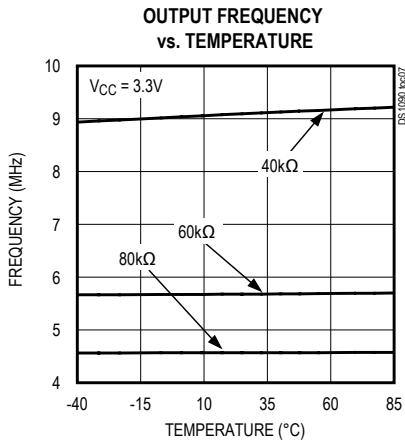

Pin Description

PIN	NAME	FUNCTION
1	OUT	Oscillator Output
2	RSET	Frequency Control Resistor Input
3	VCC	Positive-Supply Terminal
4	GND	Ground
5	J0	Dither Amplitude (Percentage) Inputs (see Table 2)
6	J1	
7	JC0	Dither Rate Divisor Inputs (see Table 1)
8	JC1	

Block Diagram

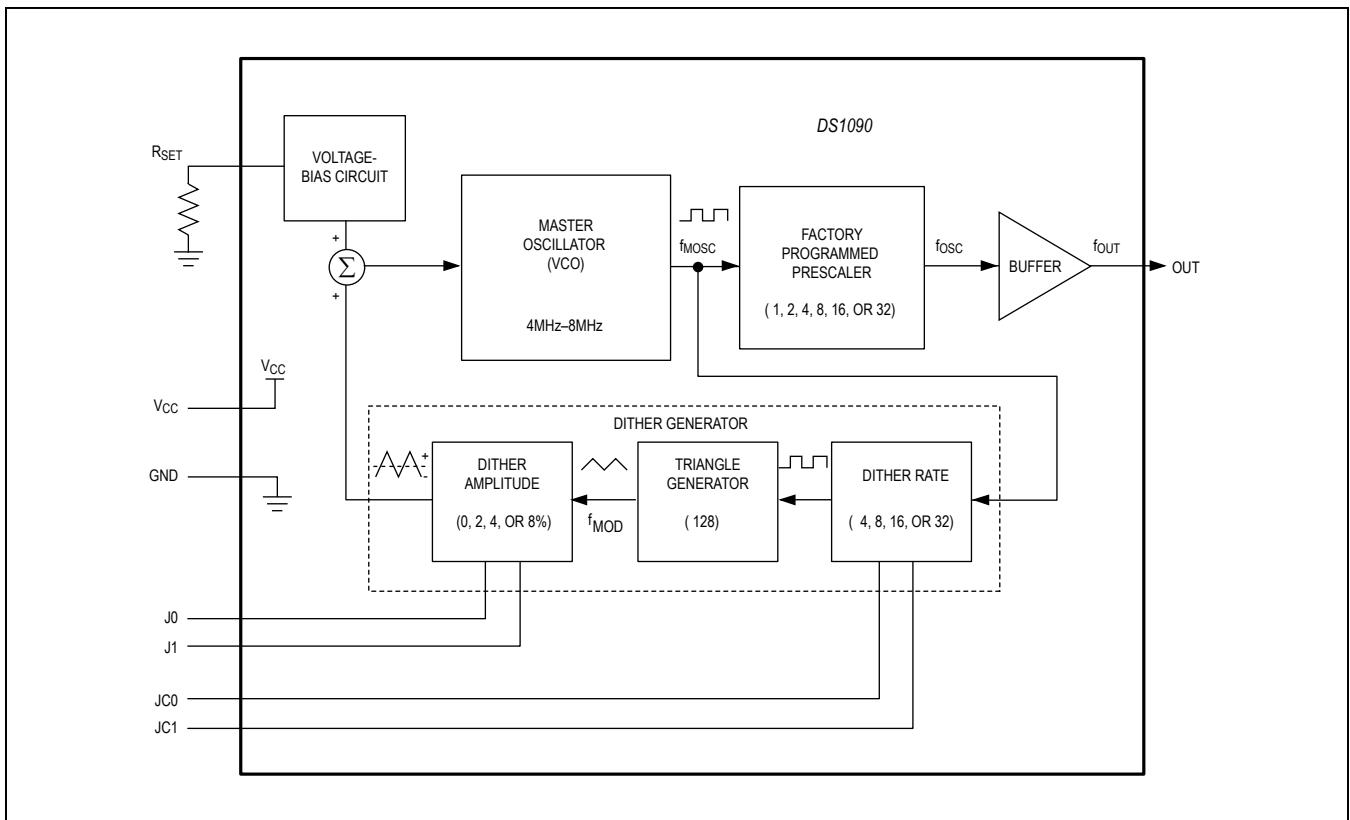

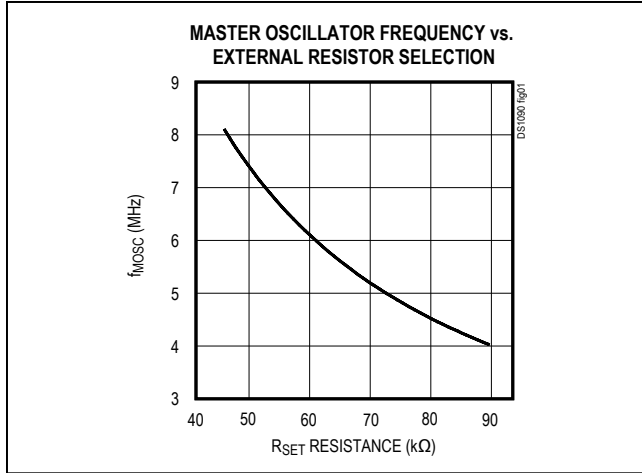

Figure 1. Master Oscillator Frequency

Detailed Description

The DS1090 is a center-dithered, spread-spectrum silicon oscillator for use as an external clock in reduced-EMI applications. With a combination of factory-programmed prescalers and a user-selected external resistor, output frequencies from 125kHz to 8MHz can be achieved. The output center frequency can be dithered by selecting the desired dither rate and amplitude with discrete inputs J0, J1, JC0, and JC1.

The DS1090 contains four basic circuit blocks: master oscillator, factory-programmed prescaler, dither generator, and the voltage-bias circuit that provides the feedback path to the master oscillator for frequency control and dithering functions.

Master Oscillator

The master oscillator is programmable in the application by the use of an external resistor (R_{SET}) tied to ground (GND). Resistor values of 45kΩ to 91kΩ vary the square-wave output frequency of the voltage-controlled master oscillator (f_{MOSC}) from 8MHz down to 4MHz (see Figure 1).

The master oscillator (Hz) frequency can be stated as

$$f_{MOSC} \cong \frac{3.6461E+11}{\text{Resistor}}$$

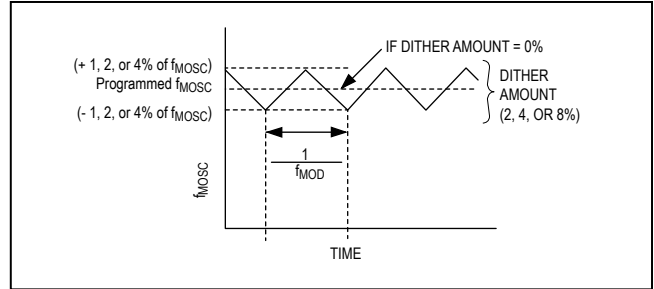

Figure 2. Center Frequency Dither Diagram

Factory-Programmed Prescaler

The prescaler divides the frequency of the master oscillator by 1, 2, 4, 8, 16, or 32 to generate the square-wave output clock (f_{OSC}). This divisor is factory-set and is an ordering option.

Dither Generator

Spread-spectrum functionality is achieved by a user-configurable divider (determines dither rate), a triangle generator, and a user-configurable dither amplitude circuit (see *Block Diagram*).

The input to the triangle-wave generator is derived from the internal master oscillator and is fed through a user-configurable divider. The settings of control pins JC0 and JC1 determine this dither rate divisor setting (see Table 1), dividing the master clock by 4, 8, 16, or 32. The clock signal is further divided by 128 in the triangle-wave generator, which results in a triangle-wave signal of either 1/512th, 1/1024th, 1/2048th, or 1/4096th of the master oscillator (f_{MOD}), depending upon the user's divisor setting.

The dithering frequency can be also expressed as the result of

$$f_{MOD} = \frac{f_{MOSC}}{\text{Divisor} \times 128}$$

where Divisor is 4, 8, 16, or 32.

Table 1. Dither Rate Divisor Settings

JC1	JC0	DITHERING PERCENTAGE (f_{MOSC}/n)	DIVISOR SETTING
0	0	$f_{MOSC} / 512$	4
0	1	$f_{MOSC} / 1024$	8
1	0	$f_{MOSC} / 2048$	16
1	1	$f_{MOSC} / 4096$	32

Table 2. Dither Percentage Setting

J1	J0	DITHER PERCENT (%)
0	0	0
0	1	2
1	0	4
1	1	8

Dither Percentage Settings

Dither amplitude (measured in percent \pm from the master oscillator center frequency) is set using input pins J0 and J1. This circuit uses a sense current from the master oscillator bias circuit to adjust the amplitude of the triangle-wave signal to a voltage level that modulates the master oscillator to a percentage of its resistor-set center frequency. This percentage is set in the end application to be 0%, 2%, 4%, or 8% (see Table 2).

Application Information**Pin Connection**

The DS1090 is intended to provide a fixed-frequency, dithered clock to be used as a clock driver for DC-DC converters and other applications requiring a low-frequency EMI-reduced clock oscillator. All control pins must be biased per Tables 1 and 2 for proper operation for the individual application's requirements. R_{SET} must be tied to ground (GND) by a customer-supplied resistor.

 R_{SET} Resistor Selection

The value of the resistor used to select the desired frequency is calculated using the formula in the *Master Oscillator* section (see also Figure 1). It is recommended to use, at minimum, a 1%-tolerance, 1/16th-watt component with a temperature coefficient that satisfies the overall stability requirements desired of the end-equipment. Place the external R_{SET} resistor as close as possible to minimize lead inductance.

Power-Supply Decoupling

To achieve best results, it is highly recommended that a decoupling capacitor is used on the IC power-supply pins. Typical values of decoupling capacitors are 0.01 μ F and 0.1 μ F. Use a high-quality, ceramic, surface-mount capacitor, and mount it as close as possible to the V_{CC} and GND pins of the IC to minimize lead inductance.

Chip Information

SUBSTRATE CONNECTED TO GROUND

Package Information

For the latest package outline information and land patterns (footprints), go to www.maximintegrated.com/packages. Note that a "+", "#", or "-" in the package code indicates RoHS status only. Package drawings may show a different suffix character, but the drawing pertains to the package regardless of RoHS status.

Revision History

REVISION NUMBER	REVISION DATE	DESCRIPTION	PAGES CHANGED
1	2/07	—	—
2	2/15	Remove automotive reference from data sheet	1
3	9/16	Corrected typo in <i>Benefits and Features</i> section	1

For pricing, delivery, and ordering information, please contact Maxim Direct at 1-888-629-4642, or visit Maxim Integrated's website at www.maximintegrated.com.

Maxim Integrated cannot assume responsibility for use of any circuitry other than circuitry entirely embodied in a Maxim Integrated product. No circuit patent licenses are implied. Maxim Integrated reserves the right to change the circuitry and specifications without notice at any time. The parametric values (min and max limits) shown in the Electrical Characteristics table are guaranteed. Other parametric values quoted in this data sheet are provided for guidance.