

3A Low Dropout Positive Adjustable Regulator

DESCRIPTION

The RH1085 positive adjustable regulator is designed to provide 3A with higher efficiency than currently available devices. All internal circuitry is designed to operate down to 1V input-to-output differential and the dropout voltage is fully specified as a function of load current. Dropout is guaranteed at a maximum of 1.5V at maximum output current, decreasing at lower load currents. On-chip trimming adjusts the output voltage to 1%. Current limit is also trimmed, minimizing the stress on both the regulator and power source circuitry under overload conditions.

The RH1085 is pin compatible with older 3-terminal regulators. A 10 μ F output capacitor is required on these new device. However, this is usually included in most regulator designs.

The wafer lots are processed to Linear Technology Corporation's in-house Class S flow-to-yield circuits usable in stringent military applications.

ABSOLUTE MAXIMUM RATINGS

(Note 1)

Power Dissipation	Internally Limited
Input-to-Output Voltage Differential	30V
Operating Junction Temperature Range	
Control Section	-55°C to 150°C
Power Transistor	-55°C to 200°C
Storage Temperature Range	-65°C to 150°C
Lead Temperature (Soldering, 10 sec)	300°C

PRECONDITIONING

100% Thermal Limit Burn-In

LT, LT, LTC, LTM, Linear Technology and the Linear logo are registered trademarks of Linear Technology Corporation. All other trademarks are the property of their respective owners.

BURN-IN CIRCUIT

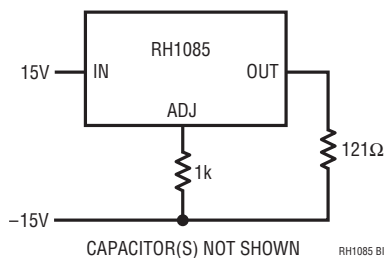

PACKAGE INFORMATION

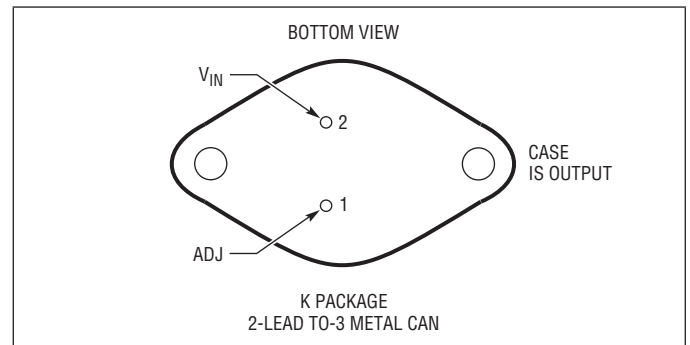

FINAL SPECIFICATIONS SUBJECT TO CHANGE

Note: For ordering information contact LTC.

TABLE 1: ELECTRICAL CHARACTERISTICS (Preirradiation)

PARAMETER	CONDITIONS	NOTES	$T_J = 25^\circ\text{C}$			SUB-GROUP	$-55^\circ\text{C} \leq T_J \leq 125^\circ\text{C}$			SUB-GROUP	UNITS
			MIN	TYP	MAX		MIN	TYP	MAX		
Reference Voltage	$I_{OUT} = 10\text{mA}$, $(V_{IN} - V_{OUT}) = 3\text{V}$		1.238	1.250	1.262	1					V
	$10\text{mA} \leq I_{OUT} \leq I_{FULL\ LOAD}$, $1.5\text{V} \leq (V_{IN} - V_{OUT}) \leq 25\text{V}$	6	1.225		1.270		1.225		1.270	2,3	V
Line Regulation	$I_{LOAD} = 10\text{mA}$, $1.5\text{V} \leq (V_{IN} - V_{OUT}) \leq 15\text{V}$ $15\text{V} \leq (V_{IN} - V_{OUT}) \leq 30\text{V}$	2, 3	0.015	0.2		1	0.035	0.2		2,3	%
				0.5		1	0.050	0.5		2,3	%
Load Regulation	$(V_{IN} - V_{OUT}) = 3\text{V}$, $10\text{mA} \leq I_{OUT} \leq I_{FULL\ LOAD}$	2, 3, 6		0.1	0.3	1		0.2	0.4	2,3	%
Dropout Voltage	$\Delta V_{REF} = 1\%$, $I_{OUT} = I_{FULL\ LOAD}$	4			1.5	1		1.3	1.5	2,3	V
Current Limit	$(V_{IN} - V_{OUT}) = 5\text{V}$ $(V_{IN} - V_{OUT}) = 25\text{V}$		3.2			1	3.2	4.0		2,3	A
			0.2			1	0.2	0.5		2,3	A
Minimum Load Current	$(V_{IN} - V_{OUT}) = 25\text{V}$				10	1		5.0	10	2,3	mA
Thermal Regulation	$T_A = 25^\circ\text{C}$, 30ms Pulse			0.004	0.02	4					%/W
Ripple Rejection	$f = 120\text{Hz}$, $C_{ADJ} = 25\mu\text{F}$, $C_{OUT} = 25\mu\text{F}$ Tantalum, $I_{OUT} = I_{FULL\ LOAD}$, $(V_{IN} - V_{OUT}) = 3\text{V}$	6	60			4	60	75		5,6	dB
Adjust Pin Current	$T_J = 25^\circ\text{C}$			55	120	1			120	2,3	μA
Adjust Pin Current Change	$10\text{mA} \leq I_{OUT} \leq I_{FULL\ LOAD}$, $1.5\text{V} \leq (V_{IN} - V_{OUT}) \leq 25\text{V}$	6			5	1		0.2	5	2,3	μA
Temperature Stability								0.5			%
Long Term Stability	$T_A = 125^\circ\text{C}$, 1000 Hrs	5						0.3			%
RMS Output Noise (% of V_{OUT})	$T_A = 25^\circ\text{C}$, $10\text{Hz} \leq f \leq 10\text{kHz}$			0.003							%
Thermal Resistance	Control Circuitry/Power Transistor	5		0.9/3.0							$^\circ\text{C}/\text{W}$

TABLE 1A: ELECTRICAL CHARACTERISTICS (Postirradiation) $T_A = 25^\circ\text{C}$, unless otherwise noted.

PARAMETER	CONDITIONS	10KRAD (Si)		20KRAD (Si)		50KRAD (Si)		100KRAD (Si)		200KRAD (Si)		UNITS
		MIN	MAX	MIN	MAX	MIN	MAX	MIN	MAX	MIN	MAX	
Reference Voltage (Note 6)	$I_{OUT} = 10\text{mA}$ ($V_{IN} - V_{OUT} = 3\text{V}$)	1.234	1.262	1.230	1.262	1.225	1.262	1.220	1.262	1.205	1.262	V
	$10\text{mA} \leq I_{OUT} \leq I_{FULL\ LOAD}$ $1.7\text{V} \leq (V_{IN} - V_{OUT}) \leq 15\text{V}$	1.220	1.275	1.219	1.275	1.215	1.275	1.210	1.275	1.20	1.275	V
Line Regulation (Notes 2, 3)	$I_{OUT} = 10\text{mA}$ $1.5\text{V} \leq (V_{IN} - V_{OUT}) \leq 15\text{V}$		0.2		0.21		0.23		0.25		0.3	%
Load Regulation (Notes 2, 3, 6)	$(V_{IN} - V_{OUT}) = 3\text{V}$ $10\text{mA} \leq I_{OUT} \leq I_{FULL\ LOAD}$		0.3		0.3		0.3		0.3		0.3	%
Dropout Voltage (Note 4)	$\Delta V_{REF} = 1\%$, $I_{OUT} = 3\text{A}$		1.5		1.5		1.55		1.6		1.65	V
Current Limit	$(V_{IN} - V_{OUT}) = 5\text{V}$	3.2		3.17		3.15		3.10		3.0		A
	$(V_{IN} - V_{OUT}) = 25\text{V}$	0.2		0.20		0.20		0.20		0.2		A
Minimum Load Current	$(V_{IN} - V_{OUT}) = 25\text{V}$		10		10		10		10		10	mA
Adjust Pin Current			120		120		120		120		120	μA
Adjust Pin Current Change (Note 6)	$10\text{mA} \leq I_{OUT} \leq I_{FULL\ LOAD}$ $1.5\text{V} \leq (V_{IN} - V_{OUT}) \leq 15\text{V}$		5		5		5		5		5	μA

Note 1: Stresses beyond those listed under Absolute Maximum Ratings may cause permanent damage to the device. Exposure to any Absolute Maximum Rating condition for extended periods may affect device reliability and lifetime.

Note 2: See thermal regulation specifications for changes in output voltage due to heating effects. Line and load regulation are measured at a constant junction temperature by low duty cycle pulse testing.

Note 3: Line and load regulation are guaranteed up to the maximum power dissipation of 30W for RH1085. Power dissipation is determined by the input/output differential voltage and the output current. Guaranteed maximum power dissipation will not be available over the full input/output voltage range.

Note 4: Dropout voltage is specified over the full output current range of the device. Test points and limits are shown on the Dropout Voltage curve in the LT[®]1085 data sheet.

Note 5: Guaranteed by design, characterization, or correlation to other tested parameters.

Note 6: For compliance with 883 revision C current density specifications, the RH1085 is rated to 2A.

TABLE 2: ELECTRICAL TEST REQUIREMENTS

MIL-STD-883 TEST REQUIREMENTS	SUBGROUP
Final Electrical Test Requirements (Method 5004)	1*,2,3,4,5,6
Group A Test Requirements (Method 5005)	1,2,3,4,5,6
Group C and D End Point Electrical Parameters (Method 5005)	1

*PDA applies to subgroup 1. See PDA Test Notes.

PDA Test Notes

The PDA is specified as 5% based on failures from group A, subgroup 1, tests after cooldown as the final electrical test in accordance with method 5004 of MIL-STD-883 Class B. The verified failures of group A, subgroup 1, after burn-in divided by the total number of devices submitted for burn-in in that lot shall be used to determine the percent for the lot.

Linear Technology Corporation reserves the right to test to tighter limits than those given.

TOTAL DOSE BIAS CIRCUIT

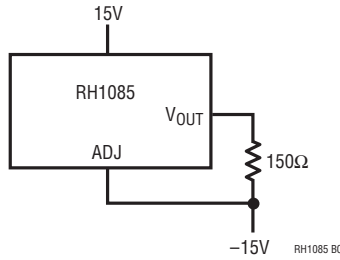

TYPICAL PERFORMANCE CHARACTERISTICS

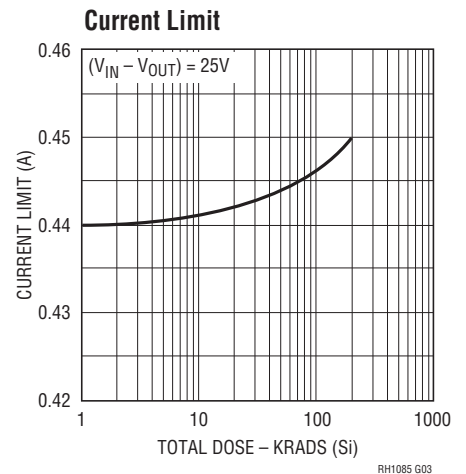
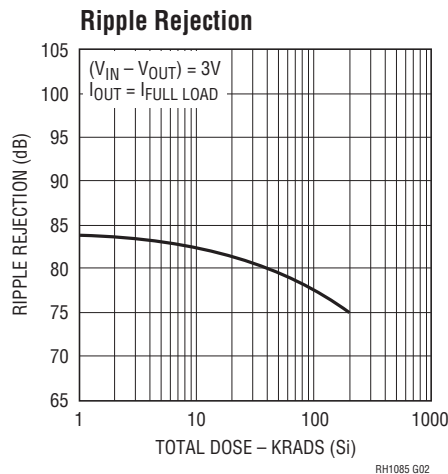
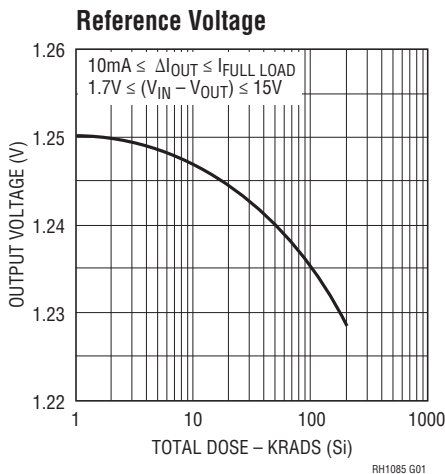

TYPICAL PERFORMANCE CHARACTERISTICS

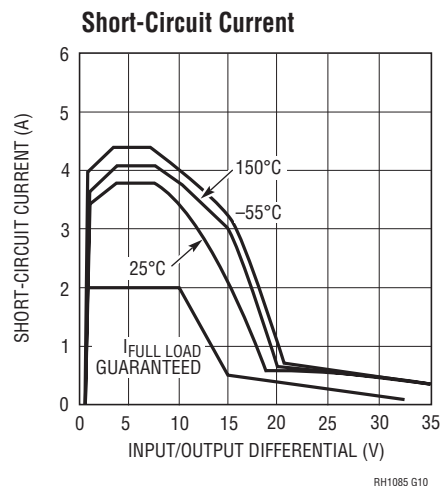
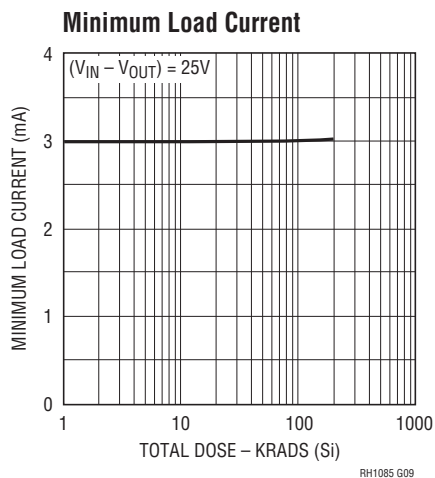
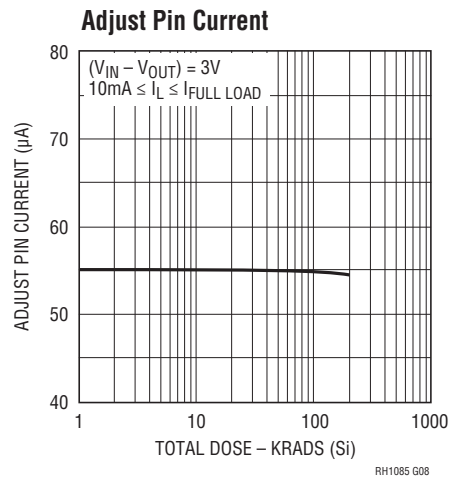
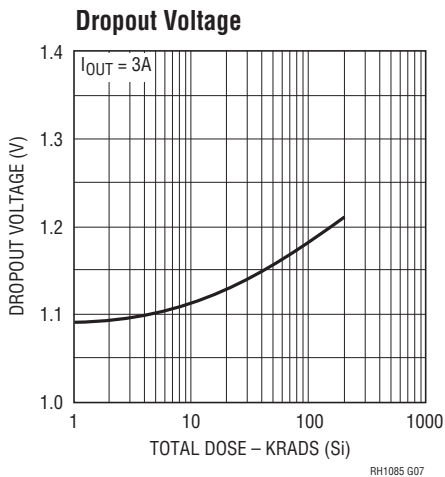
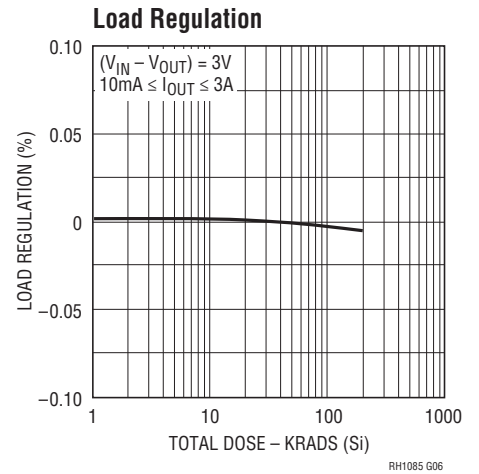
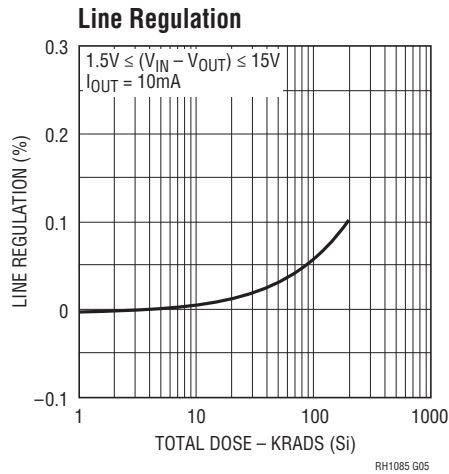
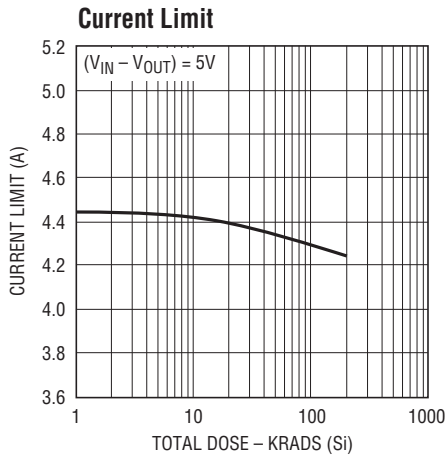

REVISION HISTORY (Revision history begins at Rev C)

REV	DATE	DESCRIPTION	PAGE NUMBER
C	10/10	Updated Reference Voltage vs Postirradiation Limits in Table 1A: Electrical Characteristics	3