

HIGH FREQUENCY LOW NOISE AMPLIFIER APPLICATION.
VHF BAND AMPLIFIER APPLICATION.

FEATURES

- Small Reverse Transfer Capacitance
: $C_{re}=0.7\text{pF(Typ.)}$.
- Low Noise Figure : $NF=2.5\text{dB(Typ.)}$ ($f=100\text{MHz}$).

MAXIMUM RATING (Ta=25 °C)

CHARACTERISTIC	SYMBOL	RATING	UNIT
Collector-Base Voltage	V_{CBO}	40	V
Collector-Emitter Voltage	V_{CEO}	30	V
Emitter-Base Voltage	V_{EBO}	4	V
Collector Current	I_C	20	mA
Emitter Current	I_E	20	mA
Collector Power Dissipation	P_C	200	mW
Junction Temperature	T_j	150	°C
Storage Temperature Range	T_{stg}	-55 ~ 150	°C

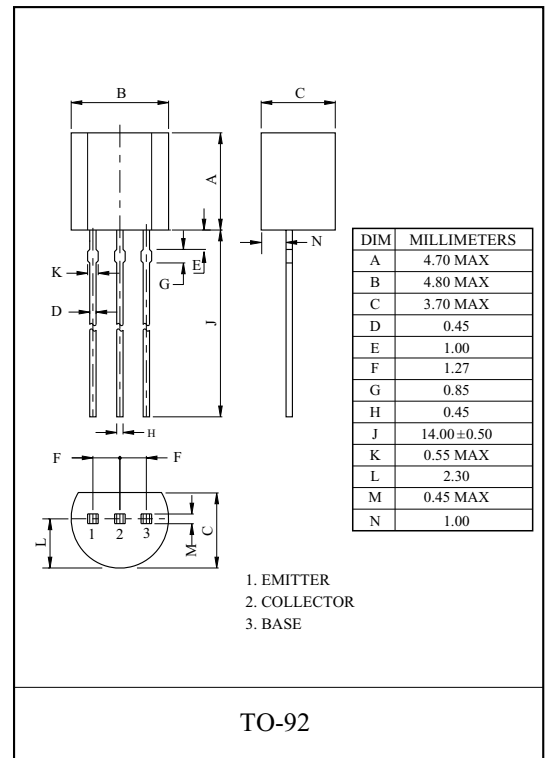

ELECTRICAL CHARACTERISTICS (Ta=25 °C)

CHARACTERISTIC	SYMBOL	TEST CONDITIONS	MIN.	TYP.	MAX.	UNIT
Collector Cut-off Current	I_{CBO}	$V_{CB}=40\text{V}, I_E=0$	-	-	0.5	μA
Emitter Cut-off Current	I_{EBO}	$V_{EB}=4\text{V}, I_C=0$	-	-	0.5	μA
DC Current Gain	h_{FE} (Note)	$V_{CE}=6\text{V}, I_C=1\text{mA}$	40	-	200	
Reverse Transfer Capacitance	C_{re}	$V_{CB}=6\text{V}, f=1\text{MHz}, I_E=0$	-	0.7	-	pF
Transition Frequency	f_T	$V_{CE}=6\text{V}, I_C=1\text{mA}$	300	550	-	MHz
Collector-Base Time Constant	$C_c \cdot r_{bb}$	$V_{CB}=6\text{V}, I_E=-1\text{mA}, f=30\text{MHz}$	-	-	30	pS
Noise Figure	NF	$V_{CC}=6\text{V}, I_E=-1\text{mA}$	-	2.5	5.0	dB
Power Gain	G_{pe}	$f=100\text{MHz}$ (Fig.)	15	18	-	

Note : h_{FE} Classification R:40 ~ 80 , O:70 ~ 140 , Y:100 ~ 200

KTC3194

Fig. NF G_{pe} TEST CIRCUIT

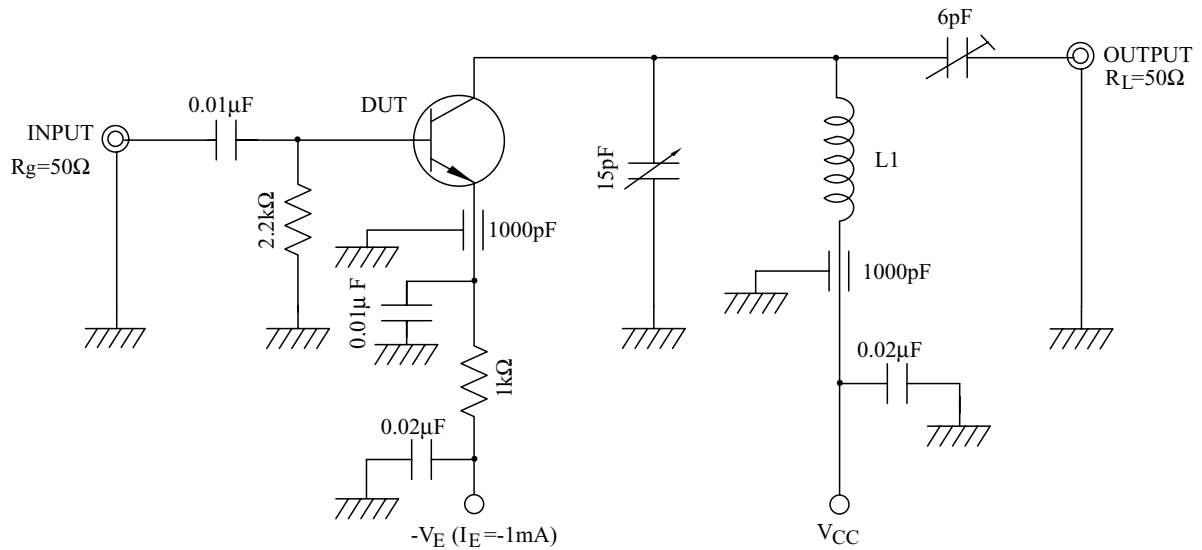

L1 : 0.8mmΦ SILVER PLATED COPPER WIRE, 4Turns.
10mm ID, 8mm Leng

y PARAMETERS (Typ.)

(1) COMMON EMITTER ($V_{CE}=6V$, $I_E=-1mA$, $f=100MHz$)

CHARACTERISTIC	SYMBOL	TYP.	UNIT
Input Conductance	g_{ie}	2	mS
Input Capacitance	C_{ie}	1.2	pF
Reverse Transfer Admittance	y_{re}	0.33	μS
Phase Angle of Reverse Transfer Admittance	θ_{re}	-90	$^{\circ}$
Forward Transfer Admittance	$ y_{fe} $	10	mS
Phase Angle of Forward Transfer Admittance	θ_{fe}	0	$^{\circ}$
Output Conductance	g_{oe}	45	μS
Output Capacitance	C_{oe}	1.1	pF

(2) COMMON BASE ($V_{CE}=6V$, $I_E=-1mA$, $f=100MHz$)

CHARACTERISTIC	SYMBOL	TYP.	UNIT
Input Conductance	g_{ib}	34	mS
Input Capacitance	C_{ib}	-10	pF
Reverse Transfer Admittance	$ y_{rb} $	0.27	μS
Phase Angle of Reverse Transfer Admittance	θ_{rb}	-105	$^{\circ}$
Forward Transfer Admittance	$ y_{fb} $	34	mS
Phase Angle of Forward Transfer Admittance	θ_{fb}	165	$^{\circ}$
Output Conductance	g_{ob}	45	μS
Output Capacitance	C_{ob}	1.1	pF

STATIC CHARACTERISTICS

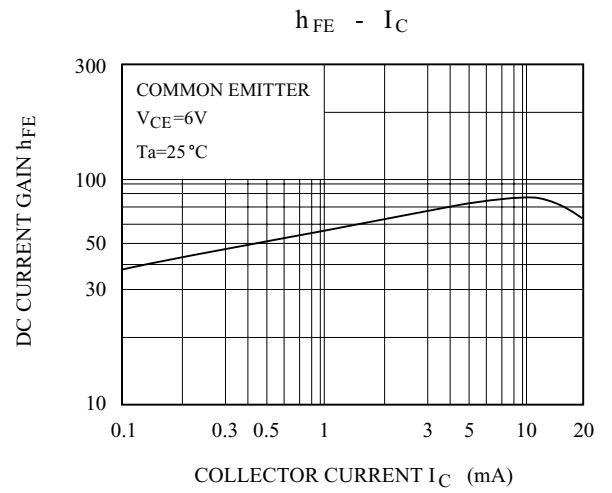
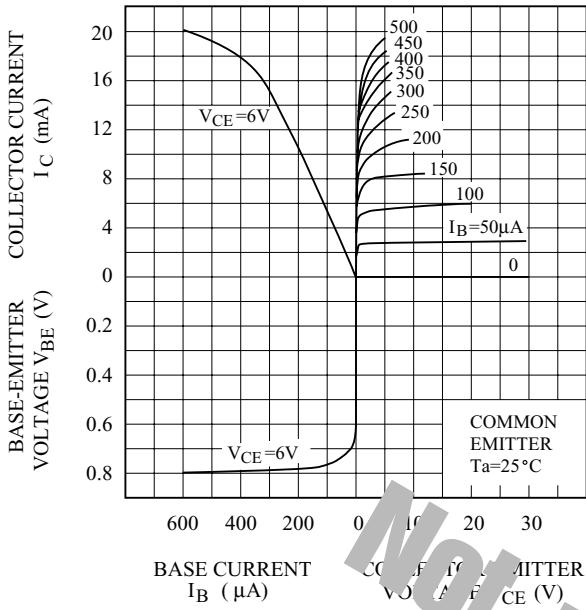

$C_{ie}, g_{ie} - I_E$

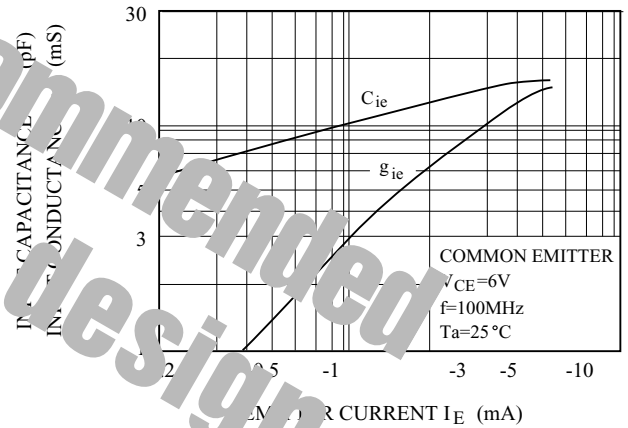

$C_{oe}, g_{oe} - I_E$

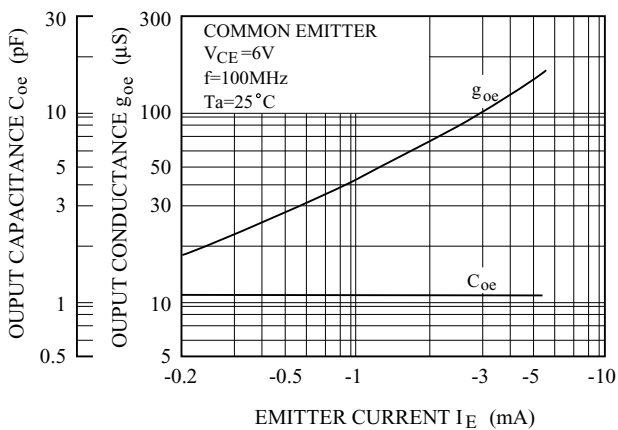

$|y_{re}|, \Theta_{re} - I_E$

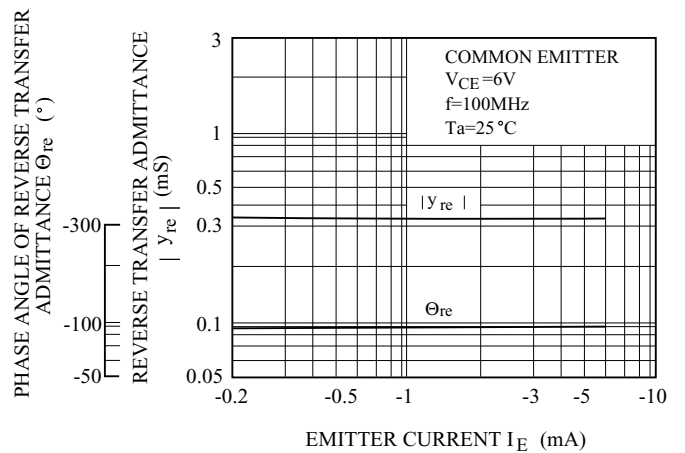

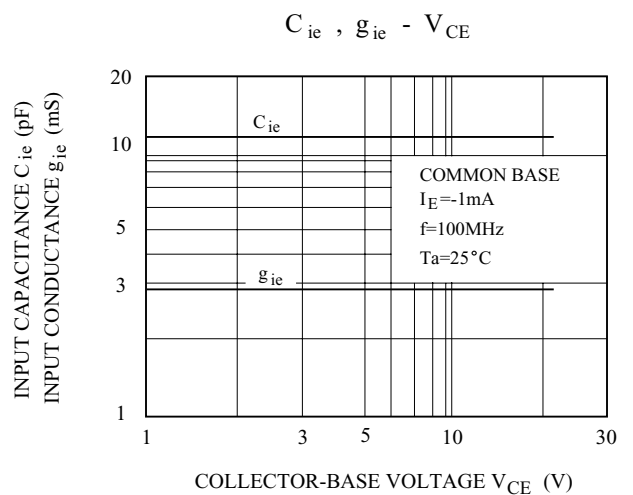
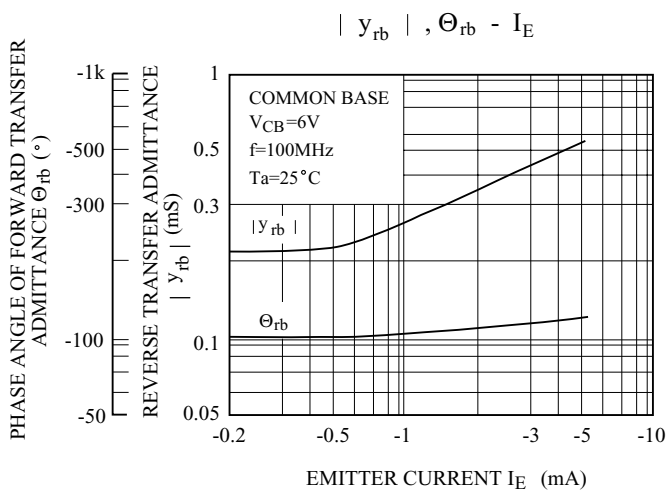
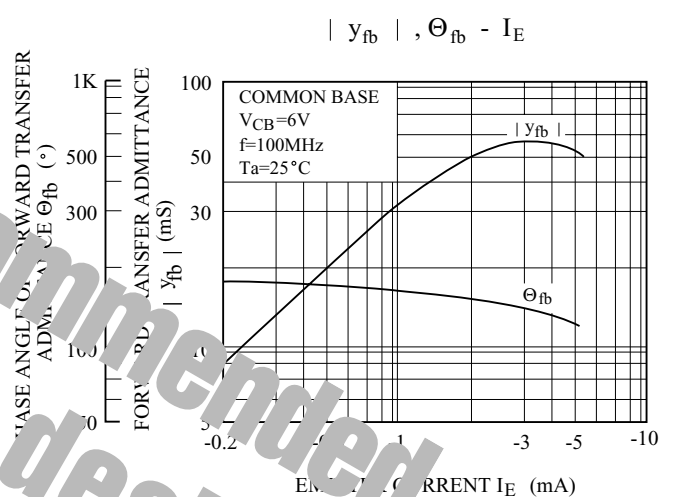
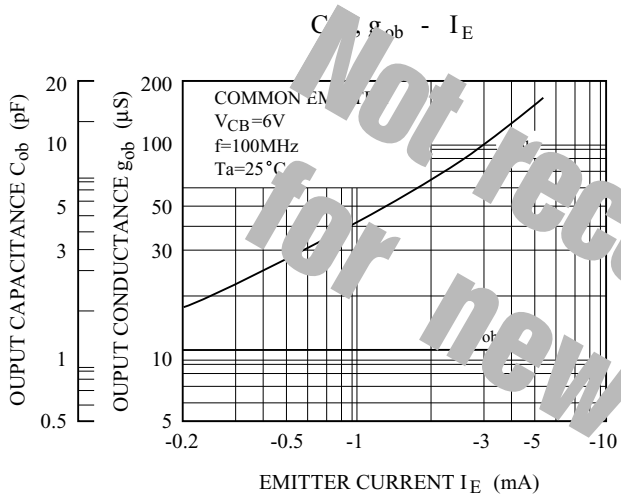
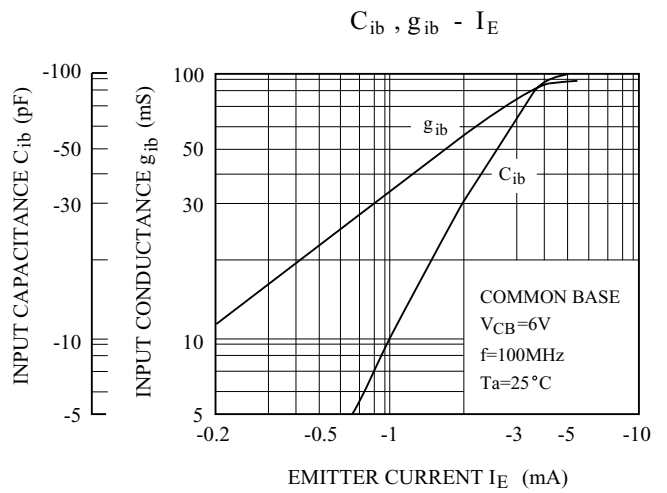
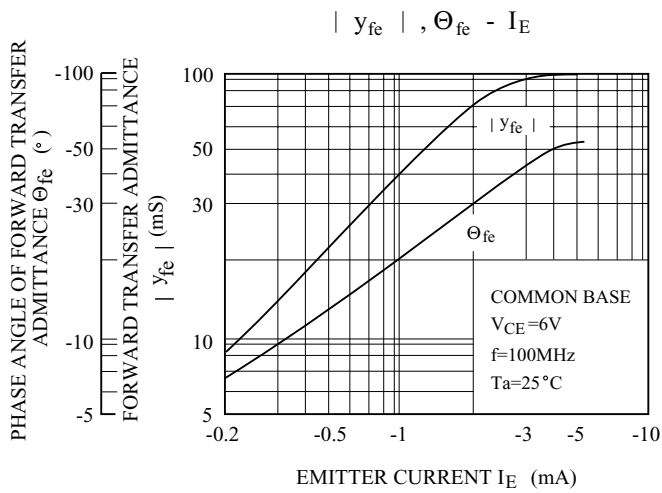

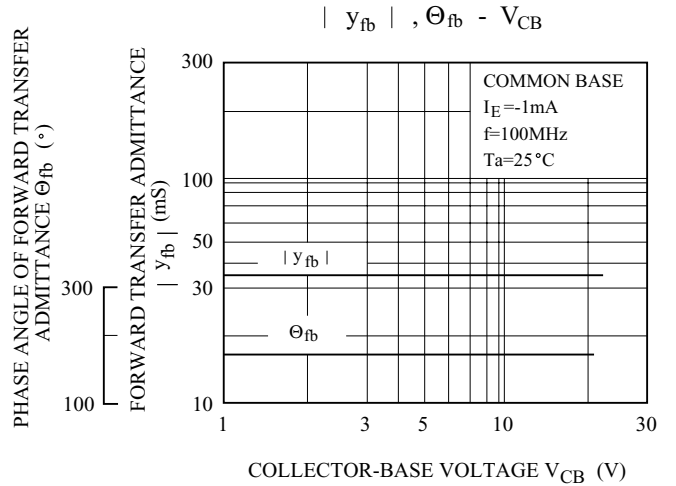
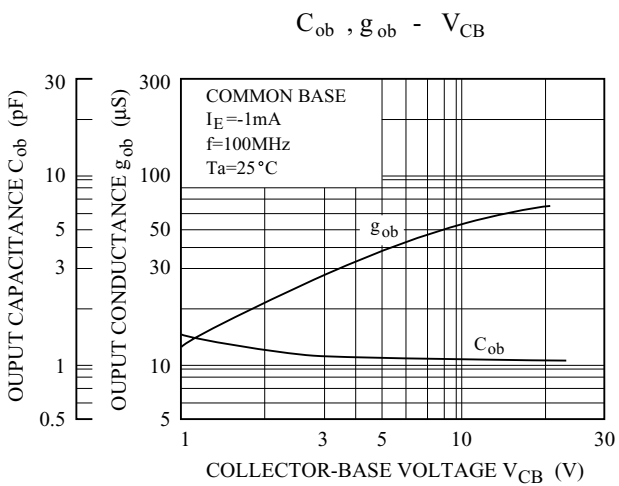
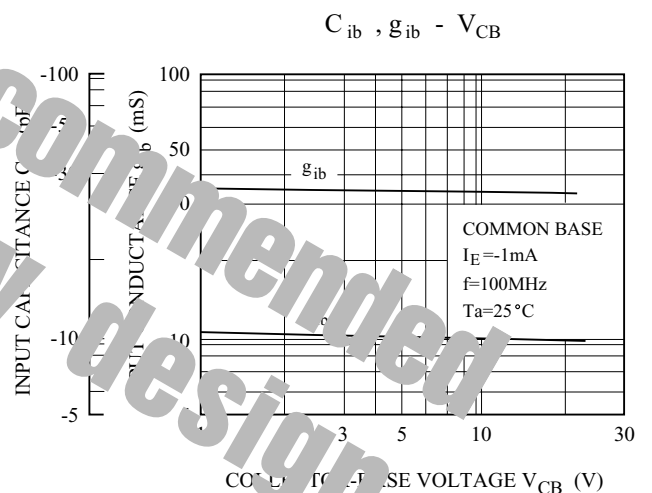
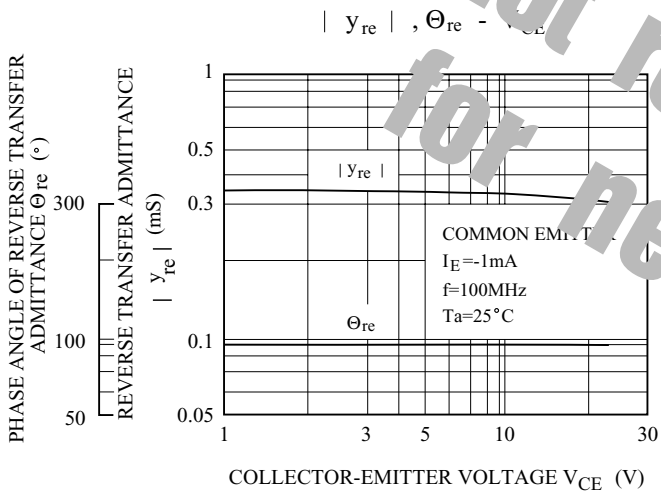
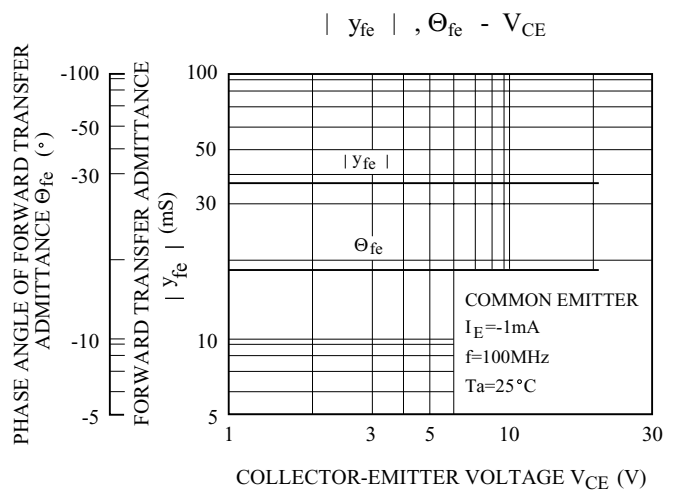
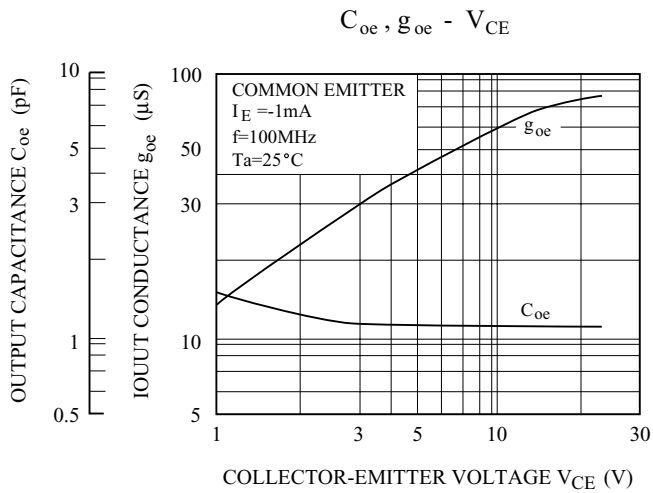

Not recommended for new design

