

C-MOS COMPARATOR WITH OPEN DRAIN OUTPUT

■ GENERAL DESCRIPTION

The NJU7112A and 14A dual and quad C-MOS Comparators performing wide operating voltage from 3 to 16V, low operating current and low offset voltage.

The NJU7112A and 14A operated on a single-power-supply can interface with most of TTL and C-MOS type standard logic ICs.

■ FEATURES

- Single-Power-Supply
- Wide Operating Voltage ($V_{DD}=3 \sim 16V$)
- Low Operating Current ($11 \mu A$ / circuit typ.)
- Wide Common Mode Input Voltage ($0 \sim 3.8V$ at $V_{DD}=5V$)
- High Input Impedance
- Low Bias Current ($I_{in}=1pA$)
- Low Offset Voltage
- Open Drain Output
- Package Outline
DIP/DMP 8 (NJU7112A)
DIP/DMP 14 (NJU7114A)
- C-MOS Technology

■ PACKAGE OUTLINE

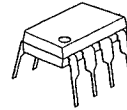

NJU7112AD



NJU7112AM

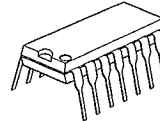

NJU7114AD

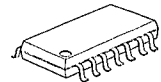

NJU7114AM

■ EQUIVALENT CIRCUIT

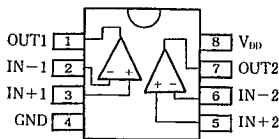

NJU7112AD/AM

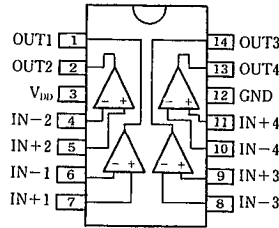

NJU7114AD/AM

■ PIN CONFIGURATION

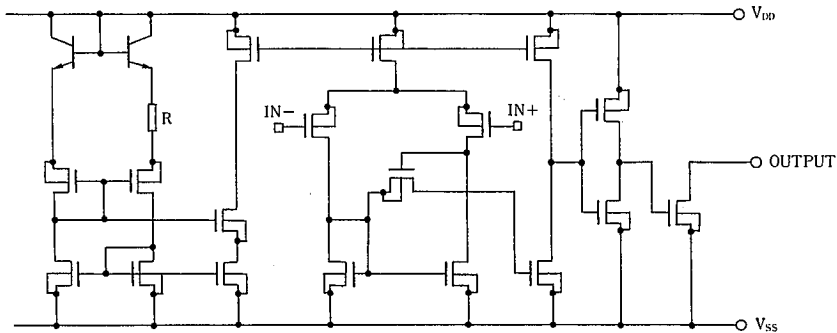

■ ABSOLUTE MAXIMUM RATINGS

(Ta=25°C)

PARAMETER	SYMBOL	RATINGS	UNIT
Supply Voltage	V _{DD}	18	V
Differential Input Voltage	V _{ID}	± 18 (Note1)	V
Input Voltage	V _I	18	V
Output Voltage	V _O	18	V
Output Current	I _O	20	mA
Power Dissipation	P _D	(DIP8) 500 (DIP14) 700 (DMP8) 300 (DMP14) 300	mW
Operating Temperature	T _{opr}	0~+70	°C
Storage Temperature	T _{stg}	-40~+125	°C

(Note1) If the supply voltage (V_{DD}) is less than 18V, the input voltage must not over the V_{DD} level though 18V is limit specified.

■ ELECTRICAL CHARACTERISTICS

(Ta=25°C, V_{DD}=5V)

PARAMETER	SYMBOL	CONDITIONS	NJU7112A			NJU7114A			UNIT
			MIN	TYP	MAX	MIN	TYP	MAX	
Operating Voltage	V _{DD}		3	—	16	3	—	16	V
Input Offset Voltage	V _{IO}	V _{IC} =V _{ICmin} (Note2)	—	1.4	12	—	1.4	12	mV
Input Offset Current	I _{IO}		—	1	—	—	1	—	pA
Input Bias Current	I _{IB}		—	1	—	—	1	—	pA
Input Common Mode Voltage Range	V _{ICM}		0	—	3.8	0	—	3.8	V
High Level Output Current	I _{OH}	V _{ID} =+1V, V _{OH} =+5V	—	2	40	—	2	40	nA
Low Level Output Voltage	V _{OL}	V _{ID} =+1V, I _{OL} =+6mA	—	0.35	0.40	—	0.35	0.40	V
Common Mode Rejection Ratio	CMR	V _{IC} =V _{ICmin}	—	71	—	—	75	—	dB
Supply Voltage Rejection Ratio	SVR	V _{DD} =5~10V	—	80	—	—	85	—	dB
Operating Current	I _{DD}	No Load, V _O =0V	—	22	40	—	44	80	μA

(Note2) This condition is available for operating voltage V_{DD}=5~10V and driving voltage is over 4.5V or under 0.3V.

■ SWITCHING CHARACTERISTICS

(Ta=25°C, V_{DD}=5V f=10kHz, C_L=15pF)

PARAMETER	SYMBOL	CONDITIONS	NJU7112A			NJU7114A			UNIT	
			MIN	TYP	MAX	MIN	TYP	MAX		
Propagation Delay High to Low	t _{PHL}	V _{IC} =0V	Over Drive=5mV	—	2.7	—	—	2.9	—	μs
			TTL level step	—	0.16	—	—	0.16	—	
Propagation Delay Low to High	t _{PLH}	V _{IC} =0V	Over Drive=5mV	—	1.5	—	—	1.5	—	μs
			TTL level step	—	0.7	—	—	0.8	—	
Output Signal Falling Time	t _{THL}	Over Drive=50mV	—	20	—	—	20	—	ns	

■ MEASUREMENT CIRCUIT

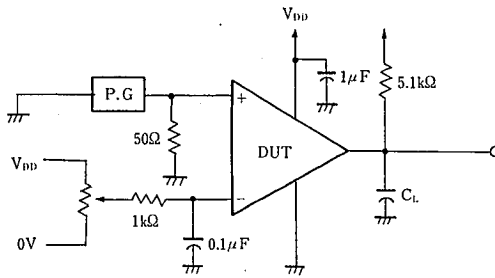

■ TIMING WAVEFORM

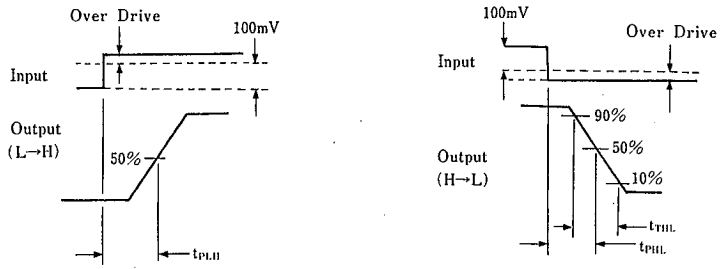

MEMO

[CAUTION]

The specifications on this databook are only given for information, without any guarantee as regards either mistakes or omissions. The application circuits in this databook are described only to show representative usages of the product and not intended for the guarantee or permission of any right including the industrial rights.