

2-INPUT 3CHANNEL VIDEO SWITCH

■ GENERAL DESCRIPTION

NJM2286 is a switching IC for switching over from one audio or video input signal to another. Internalizing 2 inputs, 1 output, and then each set of 3 can be operated independently. They are a "Clamp type" and it can be operated while DC level fixed in position of the video signal. It is a higher efficiency video switch, featuring the operating supply voltage 4.75 to 13.0V, the frequency feature 10MHz, and then the Crosstalk 75dB (at 4.43MHz).

■ PACKAGE OUTLINE

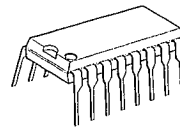

NJM2286D

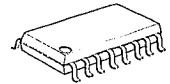

NJM2286M

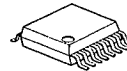

NJM2286V

■ FEATURES

- 2 Input-1 Output Internalizing 3 Circuits (Clamp type).
- Wide Operating Voltage (4.75 ~ 13.0V)
- Crosstalk 75dB (at 4.43MHz)
- Wide Bandwidth Frequency Feature 10MHz (2V<sub>pp</sub> Input)
- Package Outline DIP16, DMP16, SSOP16
- Bipolar Technology

■ APPLICATIONS

- VCR, Video Camera, AV-TV, Video Disk Player.

■ BLOCK DIAGRAM

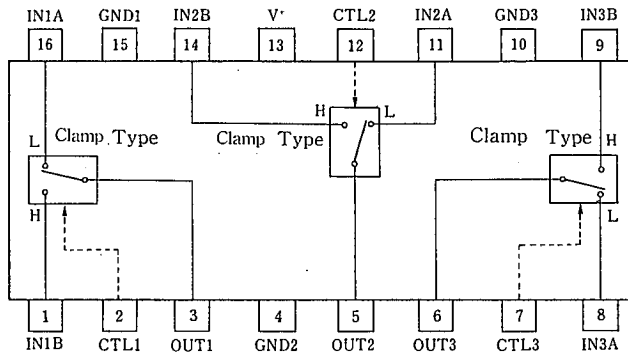

NJM2286D  
NJM2286M

## ■ MAXIMUM RATINGS

(Ta=25°C)

PARAMETER	SYMBOL	RATINGS	UNIT
Supply Voltage	V <sup>+</sup>	14	V
Power Dissipation	P <sub>D</sub>	(DIP16) 700 (DMP16) 350	mW
Operating Temperature Range	T <sub>opr</sub>	-40~+85	°C
Storage Temperature Range	T <sub>stg</sub>	-40~+125	°C

## ■ ELECTRICAL CHARACTERISTICS

(V<sup>+</sup>=5V, Ta=25°C)

PARAMETER	SYMBOL	TEST CONDITION	MIN.	TYP.	MAX.	UNIT
Operating Current (1)	I <sub>CC1</sub>	V <sup>+</sup> =5V (Note1)	7.9	11.3	14.7	mA
Operating Current (2)	I <sub>CC2</sub>	V <sup>+</sup> =9V (Note1)	9.8	14.1	18.4	mA
Voltage Gain	G <sub>V</sub>	V <sub>I</sub> = 100kHz, 2V <sub>P-P</sub> , V <sub>O</sub> /V <sub>I</sub>	-0.6	-0.1	+0.4	dB
Frequency Gain	G <sub>F</sub>	V <sub>I</sub> = 2V <sub>P-P</sub> , V <sub>O</sub> (10MHz)/V <sub>O</sub> (100kHz)	-1.0	0	+1.0	dB
Differential Gain	DG	V <sub>I</sub> = 2V <sub>P-P</sub> , Standard Staircase Signal	—	0.3	—	%
Differential Phase	DP	V <sub>I</sub> = 2V <sub>P-P</sub> , Standard Staircase Signal	—	0.3	—	deg
Output Offset Voltage	V <sub>OS</sub>	(Note2)	-15	0	+15	mV
Crosstalk	CT	V <sub>I</sub> = 2V <sub>P-P</sub> , 4.43MHz, V <sub>O</sub> /V <sub>I</sub>	—	-75	—	dB
Switch Change Over Voltage	V <sub>CH</sub>	All inside Switch ON	2.5	—	—	V
Switch Change Over Voltage	V <sub>CL</sub>	All inside Switch OFF	—	—	1.0	V

(Note1) S1=S2=S3=S4=S5=S6=S7=1

(Note2) S1=S2=S3=S4=S5=S6=1, S7=1→2 Measure the output DC voltage difference

■ TEST CIRCUIT

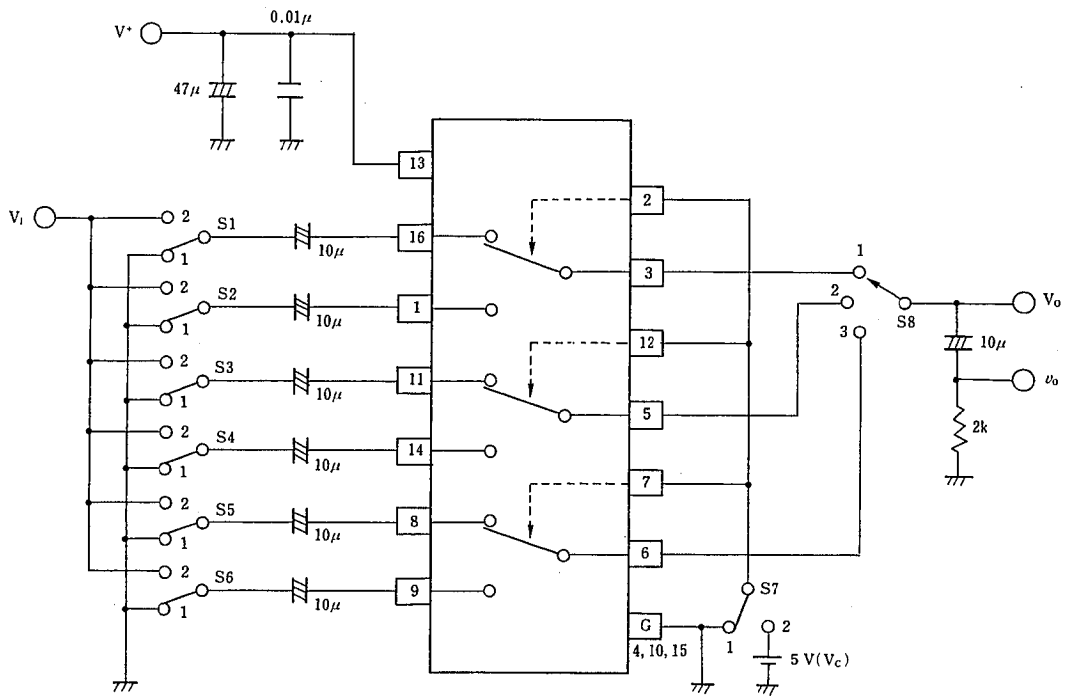

This IC requires 1MΩ resistance between INPUT and GND pin for clamp type input since the minute current causes an unstable pin voltage.

PARAMETER	S 1	S 2	S 3	S 4	S 5	S 6	S 7	S 8	TEST PART
Icc1	1	1	1	1	1	1	1	1	V+
Icc2	1	1	1	1	1	1	1	1	
Gv1	2	1	1	1	1	1	1	1	vo
Gf1	2	1	1	1	1	1	1	1	
DG1	2	1	1	1	1	1	1	1	
DP1	2	1	1	1	1	1	1	1	
CT 1	2	1	1	1	1	1	2	1	vo
CT 2	1	2	1	1	1	1	1	1	
CT 3	1	1	2	1	1	1	2	2	
CT 4	1	1	1	2	1	1	1	2	
CT 5	1	1	1	1	2	1	2	3	
CT 6	1	1	1	1	1	2	1	3	
Vos1	1	1	1	1	1	1	1/2	1	Vo
Vc1	1/2	2/1	1	1	1	1	Vc	1	Vc
THD	2	1	1	1	1	1	1	1	vo

## ■ TERMINAL EXPLANATION

PIN No.	PIN NAME	VOLTAGE	INSIDE EQUIVALENT CIRCUIT
16 1 11 14 8 9	IN 1 A IN 1 B IN 2 A IN 2 B IN 3 A IN 3 B (Input)	1.5V	
2 12 7	CTL 1 CTL 2 CTL 3 (Switching)		
3 5 6	OUT 1 OUT 2 OUT 3 (Output)	0.8V	
13	V+	5V	
15 4 10	GND 1 GND 2 GND 3		

■ TYPICAL CHARACTERISTICS

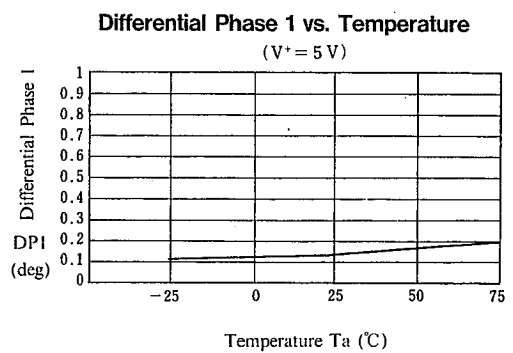
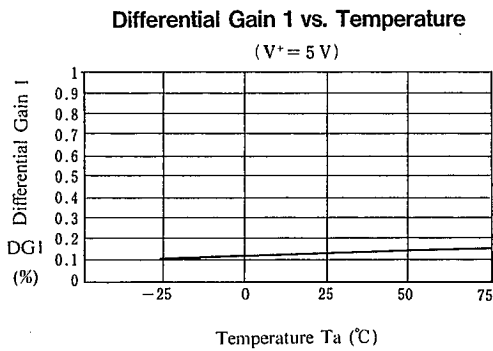
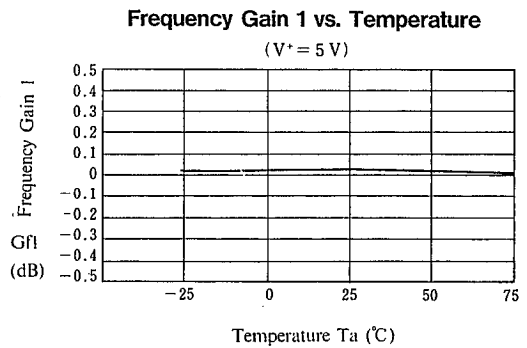
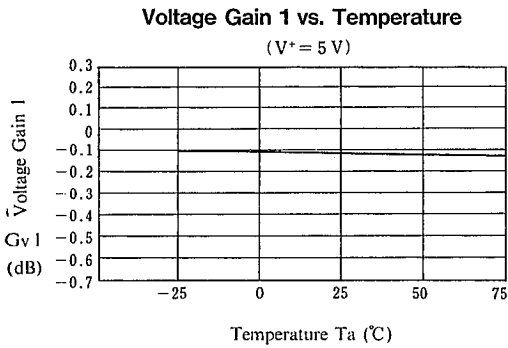
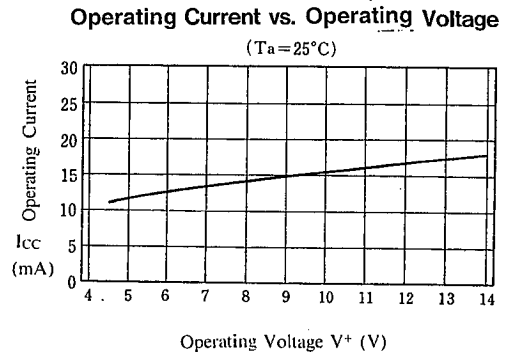
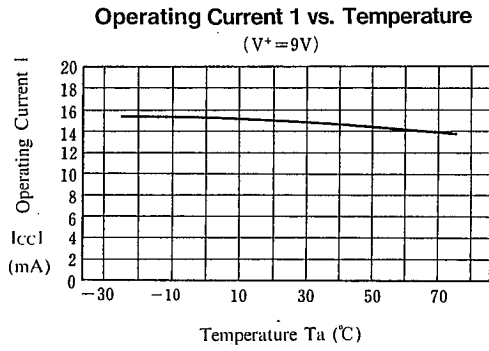

5

## TYPICAL CHARACTERISTICS

Offset Voltage vs. Temperature

( $V^+ = 5\text{ V}$ )

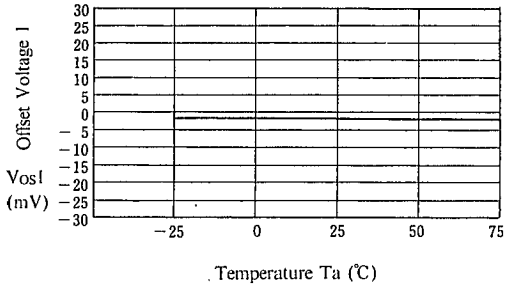

Crosstalk 1 vs. Temperature

( $V^+ = 5\text{ V}$ )

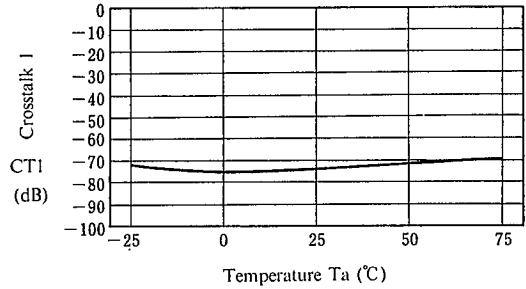

Crosstalk 2 vs. Temperature

( $V^+ = 5\text{ V}$ )

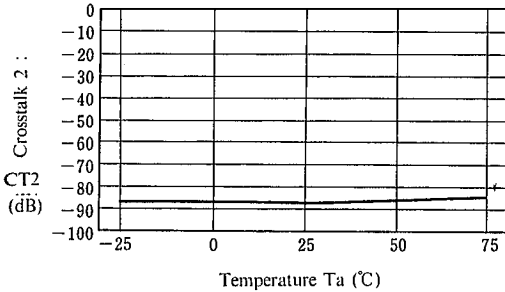

Crosstalk 3 vs. Temperature

( $V^+ = 5\text{ V}$ )

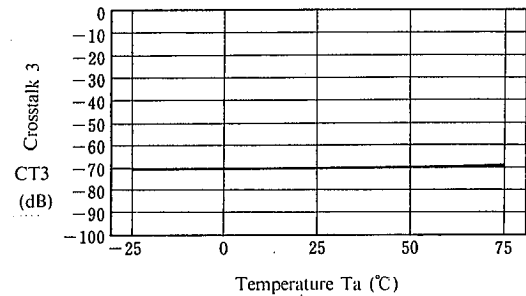

Crosstalk 4 vs. Temperature

( $V^+ = 5\text{ V}$ )

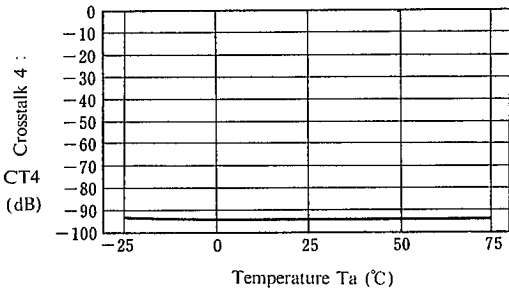

Crosstalk 5 vs. Temperature

( $V^+ = 5\text{ V}$ )

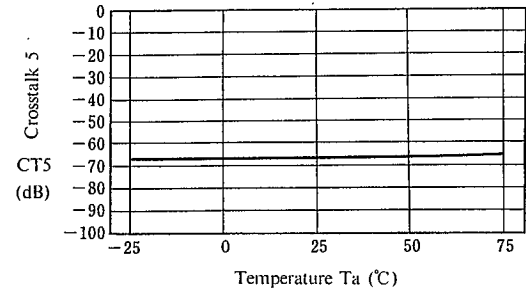

■ TYPICAL CHARACTERISTICS

Crosstalk 6 vs. Temperature

( $V^+ = 5\text{ V}$ )

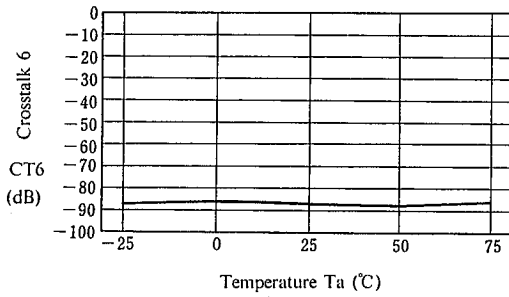

Switch Change Over 1 vs. Temperature

( $V^+ = 5\text{ V}$ )

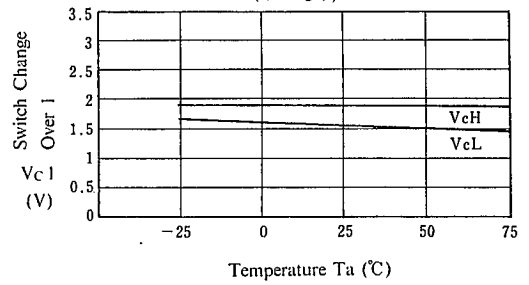

Supply Current 2 vs. Temperature

( $V^+ = 5\text{ V}$ )

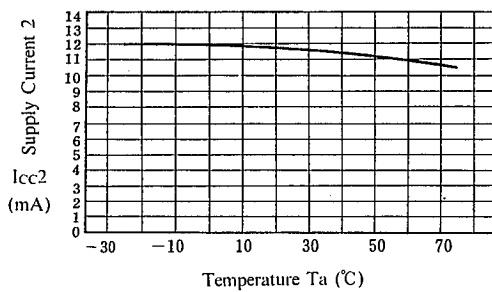

Voltage Gain 1 vs. Operating Voltage

( $T_a = 25^\circ\text{C}$ )

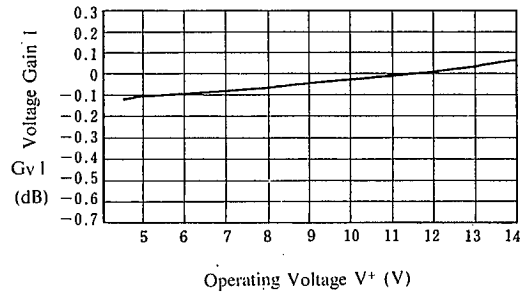

Frequency Gain 1 vs. Operating Voltage

( $T_a = 25^\circ\text{C}$ )

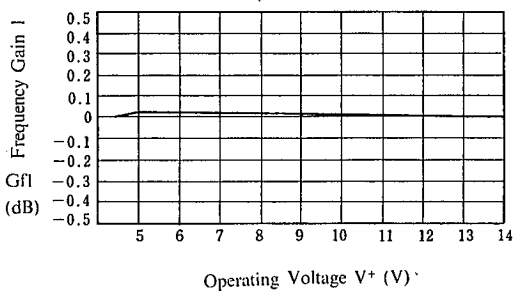

Differential Gain 1 vs. Operating Voltage

( $T_a = 25^\circ\text{C}$ )

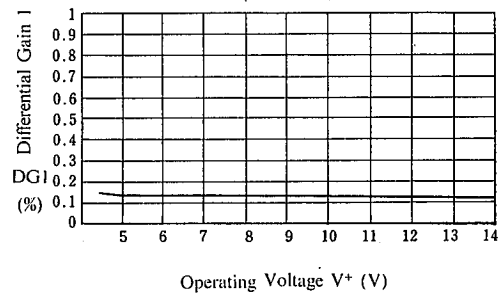

## ■ TYPICAL CHARACTERISTICS

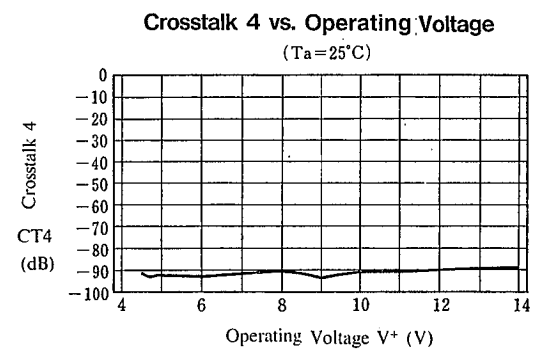
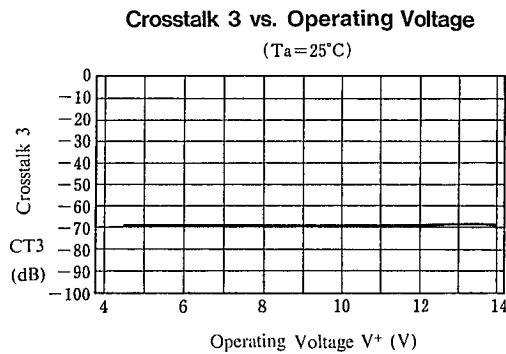
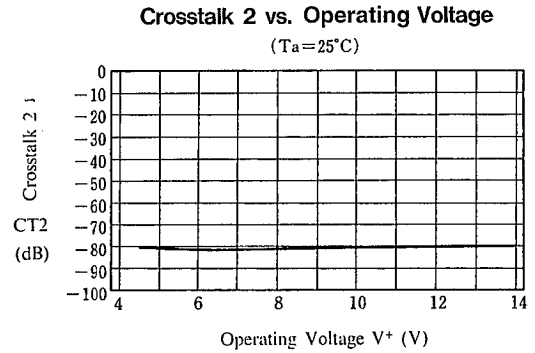
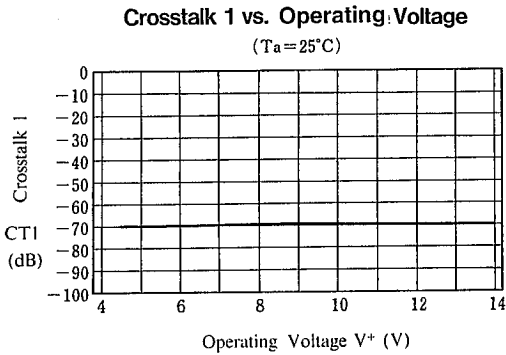
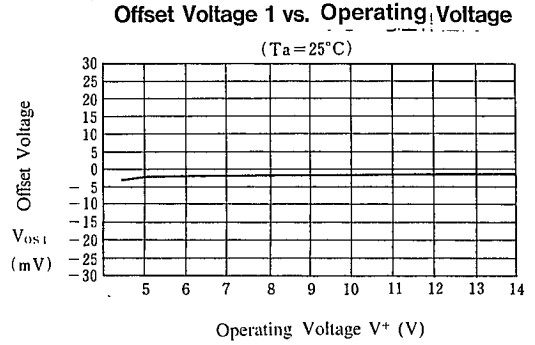
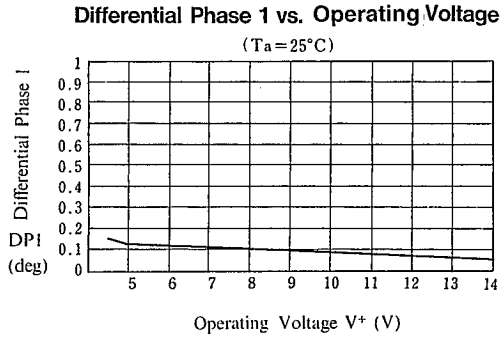



■ TYPICAL CHARACTERISTICS

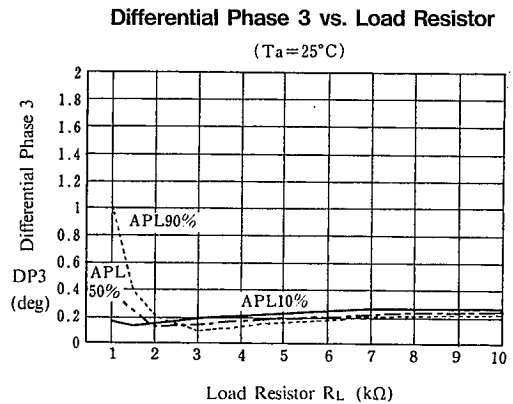
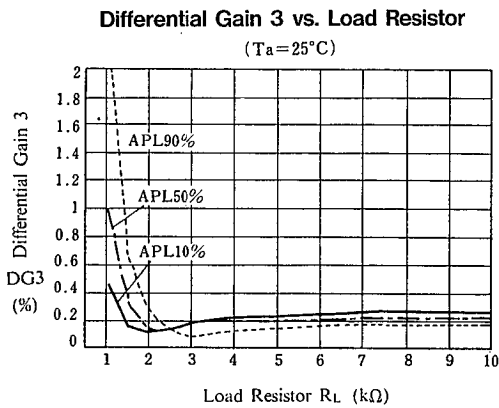
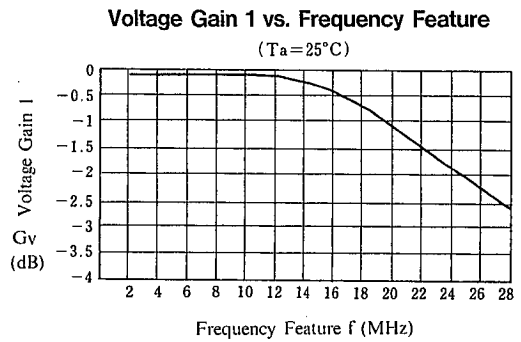
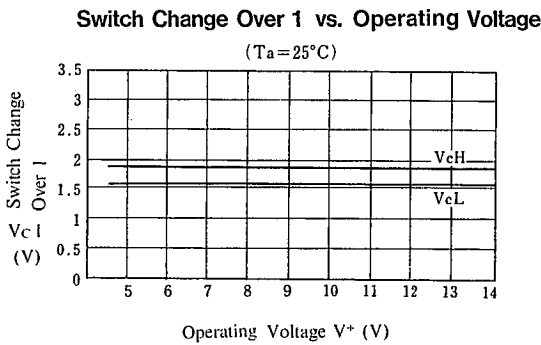
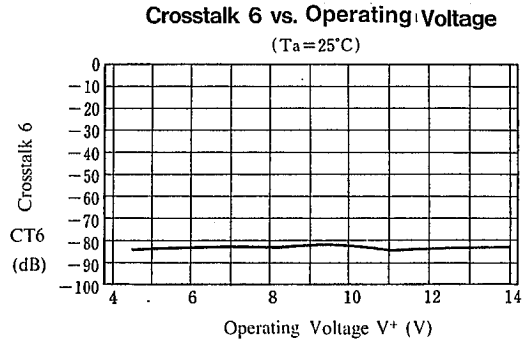
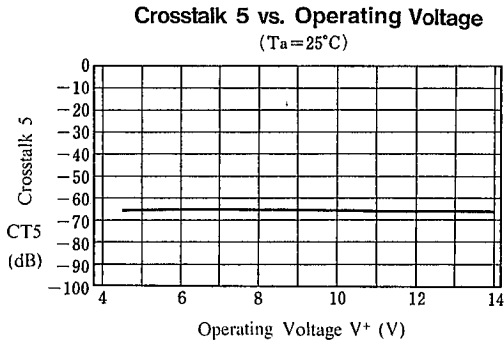

## ■ TYPICAL CHARACTERISTICS

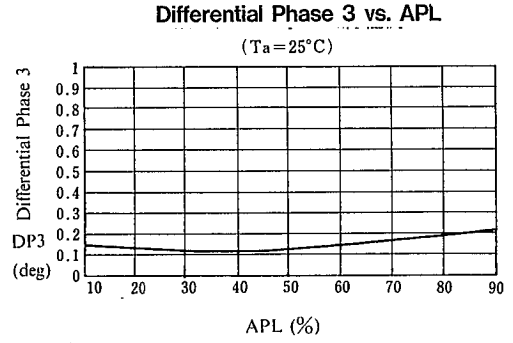
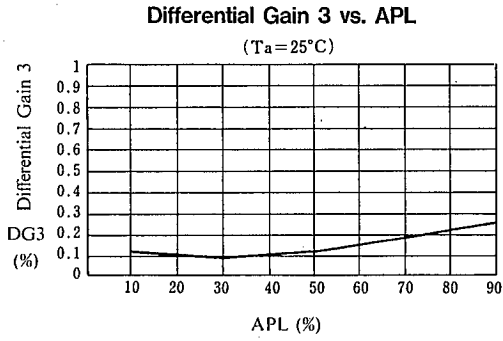

## MEMO

[CAUTION]

The specifications on this databook are only given for information, without any guarantee as regards either mistakes or omissions. The application circuits in this databook are described only to show representative usages of the product and not intended for the guarantee or permission of any right including the industrial rights.