

3-INPUT/2-INPUT VIDEO SWITCH

■ GENERAL DESCRIPTION

The NJM2506 is video switch for video and audio signal. It contains 3 input-1 output and 2 input-1 output video switch. 3 input-1 output switch has clamp function and so is applied to fixed DC level of video signal. Its operating voltage is 4.75 to 13V and bandwidth is 10MHz. Crosstalk is 75dB (at f=4.43MHz).

■ FEATURES

- Wide Operating Supply Range (+4.75V ~ +13V)
- 3 Input-1 Output and 2 Input-1 Output
- Internal Clamp Function
- Crosstalk 75dB(at 4.43MHz)
- Wide Frequency Range 10MHz(2V_{P-P} Input)
- Package Outline DIP16, DMP16, SSOP16
- Bipolar Technology

■ RECOMMENDED OPERATING CONDITION

- Operating Voltage V⁺ 4.75~13.0V

■ APPLICATION

- VCR, Video Camera, AV-TV, Video Disk Player.

■ BLOCK DIAGRAM

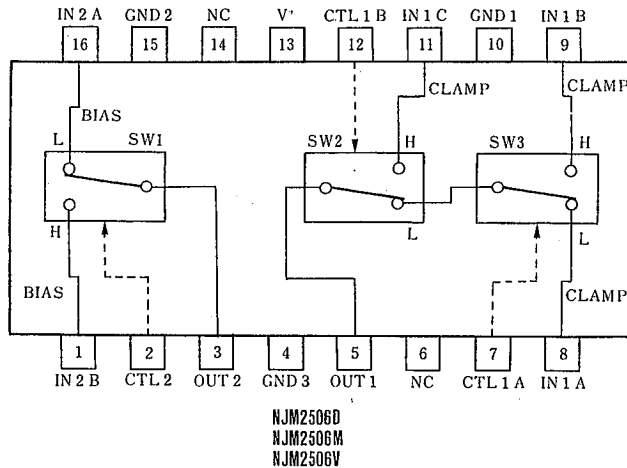

■ PACKAGE OUTLINE

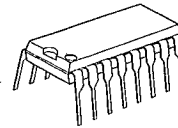

NJM2506D

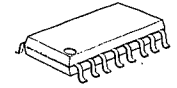

NJM2506M



NJM2506V

5

■ ABSOLUTE MAXIMUM RATINGS

(Ta=25°C)

PARAMETER	SYMBOL	RATINGS	UNIT
Supply Voltage	V*	14	V
Power Dissipation	Pd	(DIP16) 700	mW
		(DMP16) 350	mW
		(SSOP16) 300	mW
Operating Temperature Range	T _{opr}	-20~+75	°C
Storage Temperature Range	T _{stg}	-40~+125	°C

■ ELECTRICAL CHARACTERISTICS

(V*=5V, Ta=25°C)

PARAMETER	SYMBOL	TEST CONDITION	MIN.	TYP.	MAX.	UNIT
Operating Current (1)	I _{CC1}	V*=5V (Note1)	6.7	9.7	12.7	mA
Operating Current (2)	I _{CC2}	V*=9V (Note1)	8.6	12.3	16.0	mA
Voltage Gain	G _v	V _i = 2V _{p,p} /100kHz, V _O /V _i	-0.6	-0.1	+0.4	dB
Frequency Response	G _f	V _i = 2V _{p,p} , V _O (10MHz/100kHz)	-1.0	0	+1.0	dB
Differential Gain	DG	V _i = 2V _{p,p} , Staircase Signal	—	0.3	—	%
Differential Phase	DP	V _i = 2V _{p,p} , Staircase Signal	—	0.3	—	deg
Output Offset Voltage (1)	V _{OS1}	(Note2)	-10	0	+10	mV
Output Offset Voltage (2)	V _{OS2}	(Note3)	-30	0	+30	mV
Crosstalk	CT	V _i = 2V _{p,p} , 4.43MHz, V _O /V _i	—	-75	—	dB
Switch Change Voltage	V _{CH}	All inside SW: ON	2.5	—	—	V
Switch Change Voltage	V _{CL}	All inside SW: OFF	—	—	1.0	V

(Note 1): S1=S2=S3=S4=S5=S6=S7=1

(Note 2): Output DC Voltage Difference is tested on S6=1→2, S1=S2=S3=S4=S5=1, S8=2 and S7=1

(Note 3): Output DC Voltage Difference is tested on S6=1→2, S7=1(or S6=1, S7=1→2.), S1=S2=S3=S4=S5=1 and S8=1

■ TEST CIRCUIT

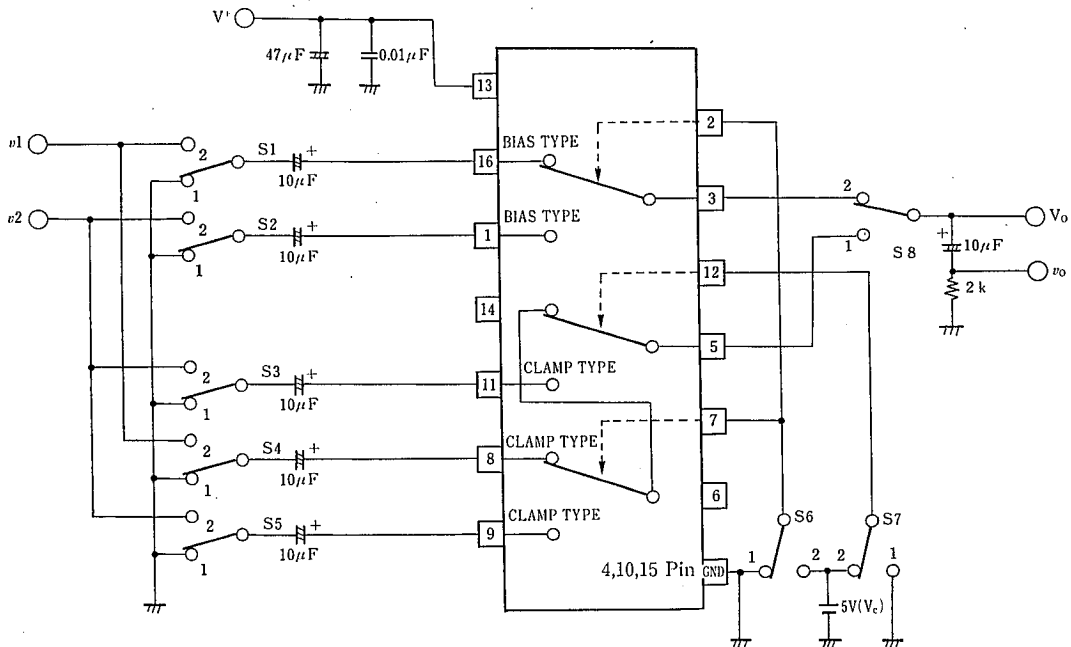

This IC requires 1MΩ resistance between INPUT and GND pin for clamp type input since the minute current causes an unstable pin voltage.

■ PIN FUNCTION

PIN No.	PIN NAME	DC VOLTAGE	INSIDE EQUIVALENT CIRCUIT
16 1	IN 2 A IN 2 B (Input)	2.5V	
8 9 11	IN 1 A IN 1 B IN 1 C (Input)	1.5V	
7 12 2	CTL 1 A CTL 1 B CTL 2 (Control)		
5	OUT 1 (Output)	1.8V	
3	OUT 2 (Output)	0.8V	
13	V+	5V	
15 4 10	GND 1 GND 2 GND 3		

5

■ TYPICAL CHARACTERISTICS ($T_a = +25^\circ\text{C}$)

Operating Current vs. Operating Voltage

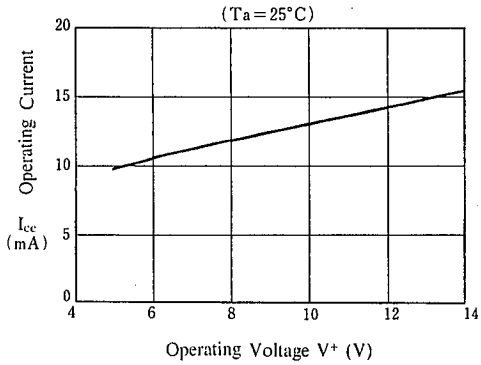

Operating Current vs. Ambient Temperature

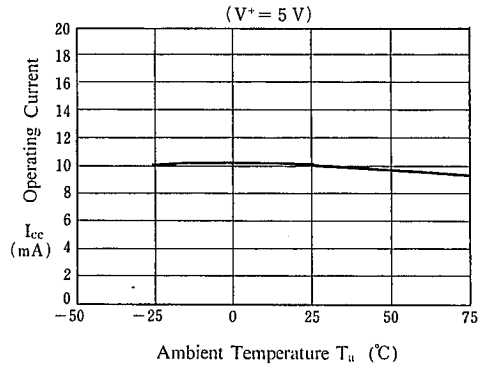

Operating Current vs. Ambient Temperature

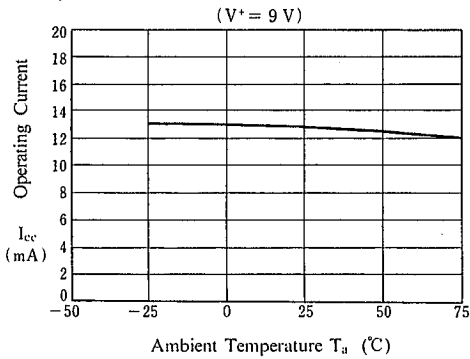

Voltage Gain vs. Operating Voltage

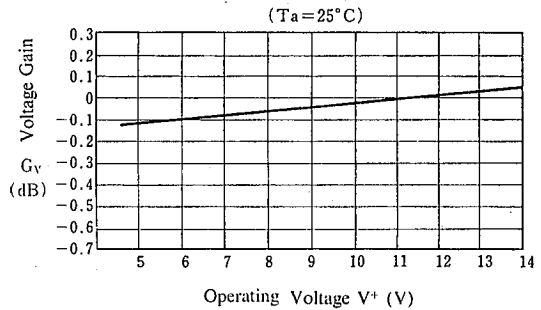

Voltage Gain vs. Frequency

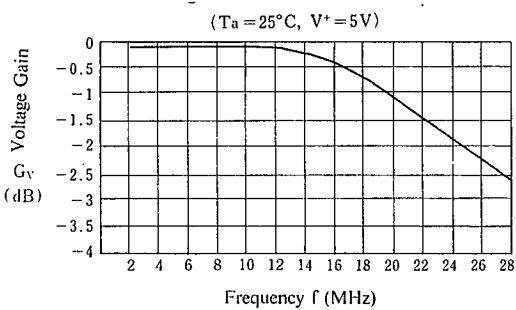

Voltage Gain vs. Ambient Temperature

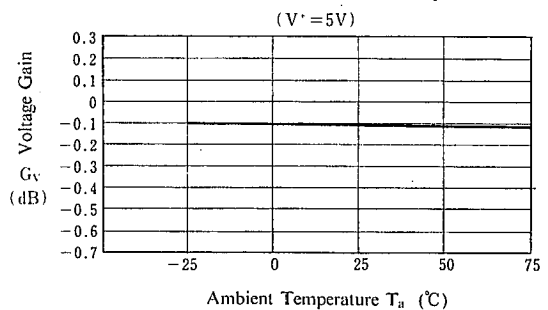

■ TYPICAL CHARACTERISTICS (Ta=+25°C)

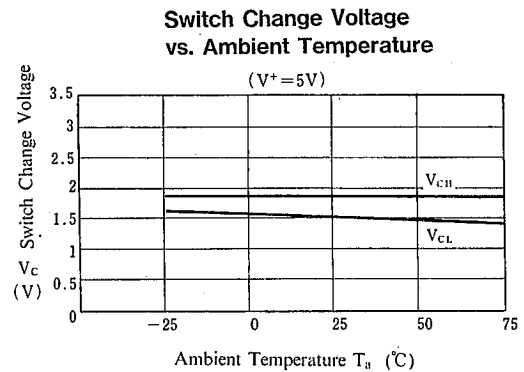
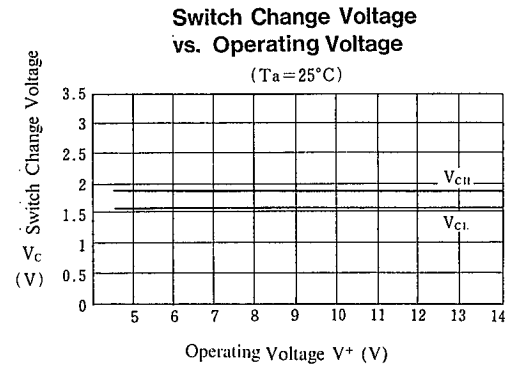
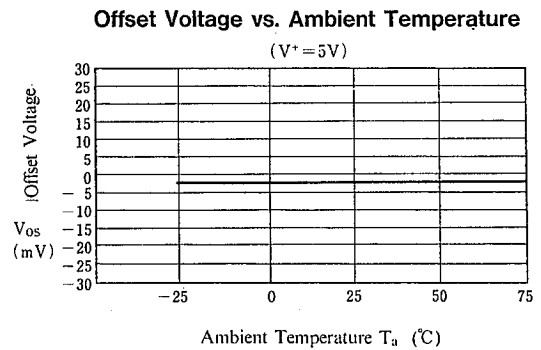
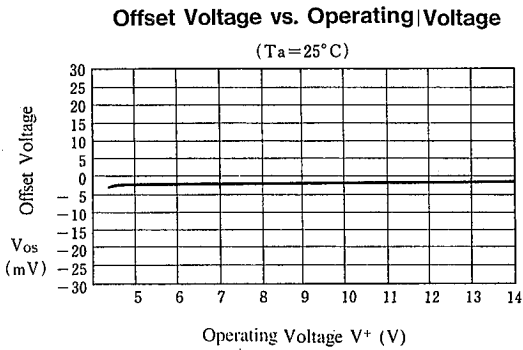
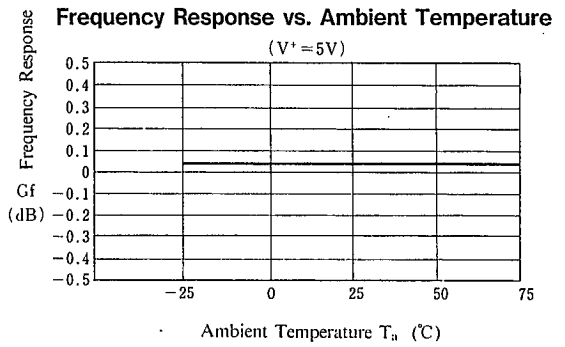
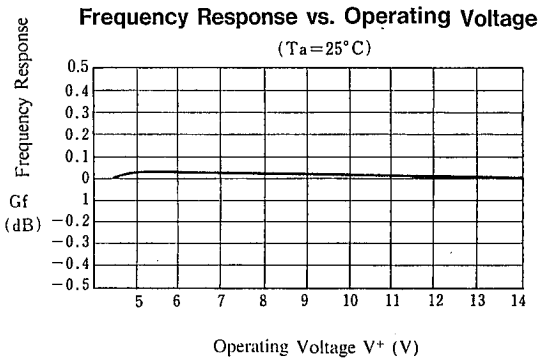

5

■ TYPICAL CHARACTERISTICS (Ta=+25°C)

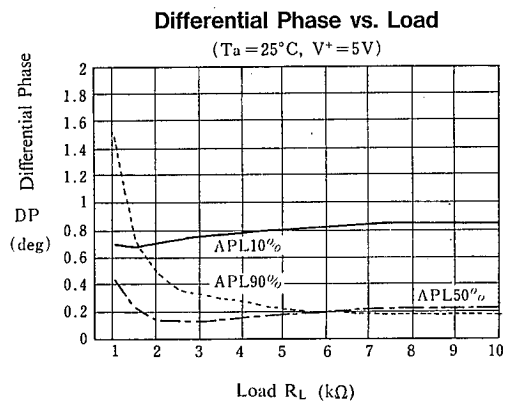
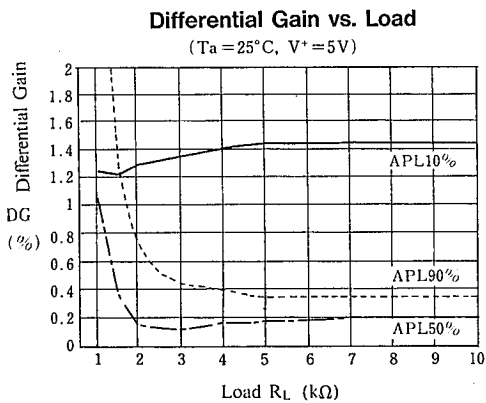
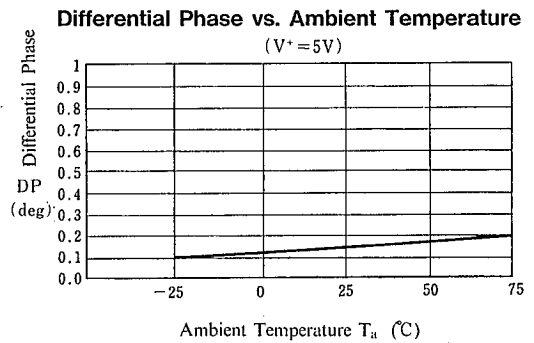
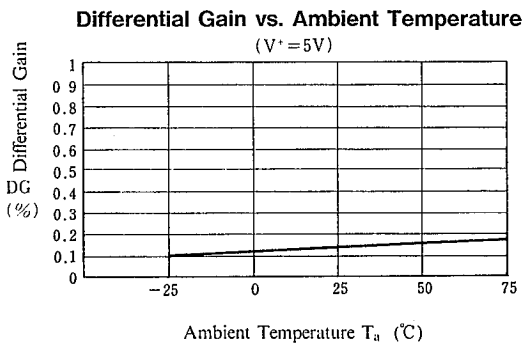
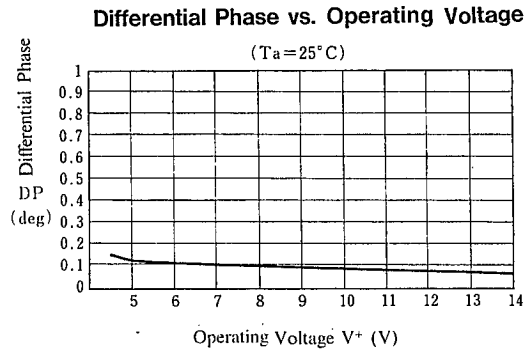
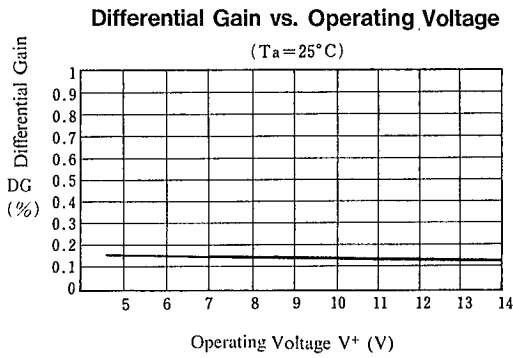

■ TYPICAL CHARACTERISTICS (Ta=+25°C)

Differential Gain vs. APL

(Ta=25°C, V+=5V)

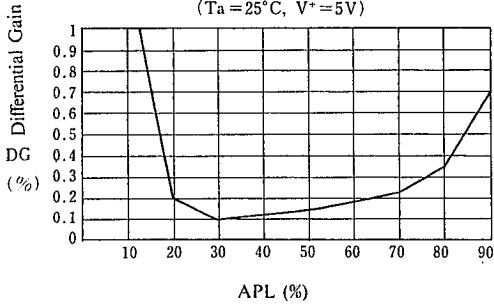

Differential Phase vs. APL

(Ta=25°C, V+=5V)

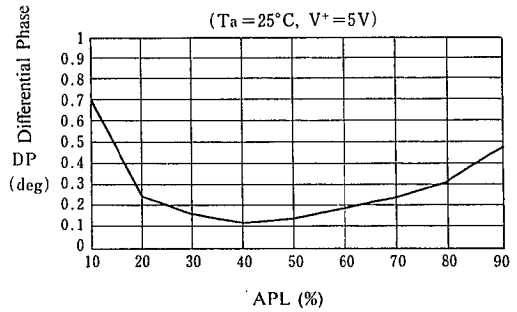

Differential Gain vs. Load

(Ta=25°C, V+=5V)

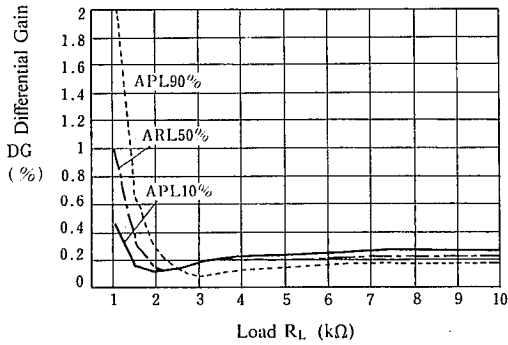

Differential Phase vs. Load

(Ta=25°C, V+=5V)

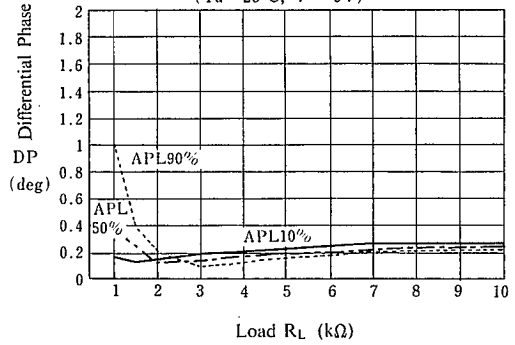

Differential Gain vs. APL

(Ta=25°C, V+=5V)

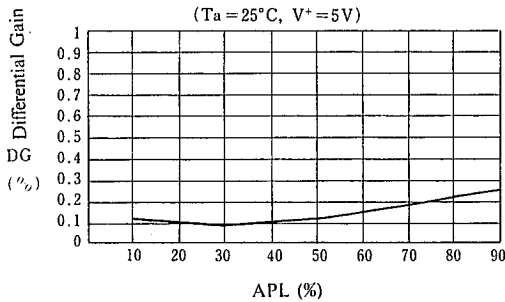

Differential Phase vs. APL

(Ta=25°C, V+=5V)

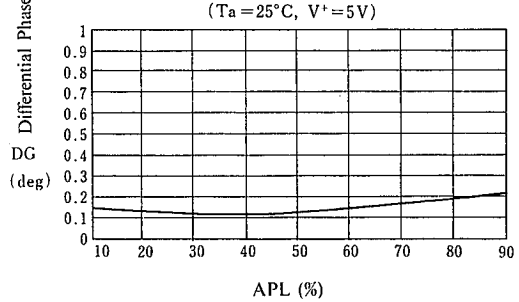

■ TYPICAL CHARACTERISTICS ($T_a = +25^\circ\text{C}$)

Crosstalk(IN2A to OUT2)vs. Operating Voltage
($T_a = 25^\circ\text{C}$)

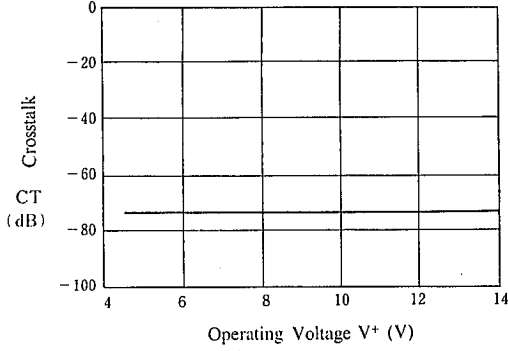

Crosstalk(IN2A to OUT2)vs. Ambient Temperature
($V^+ = 5\text{V}$)

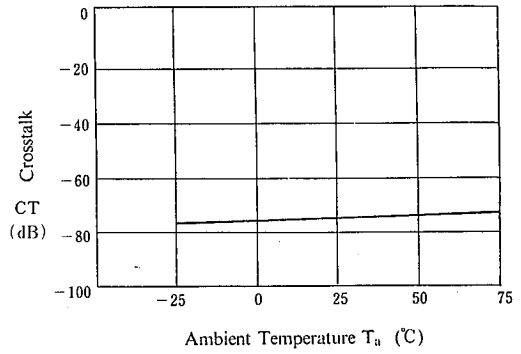

Crosstalk(IN1B to OUT1)vs. Operating Voltage
($T_a = 25^\circ\text{C}$)

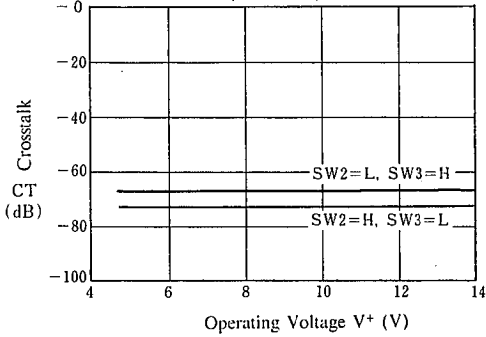

Crosstalk(IN1B to OUT1)vs. Ambient Temperature
($V^+ = 5\text{V}$)

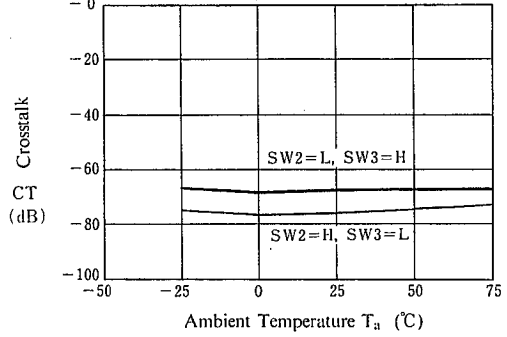

Crosstalk(IN1B to OUT1)vs. Operating Voltage
($T_a = 25^\circ\text{C}$)

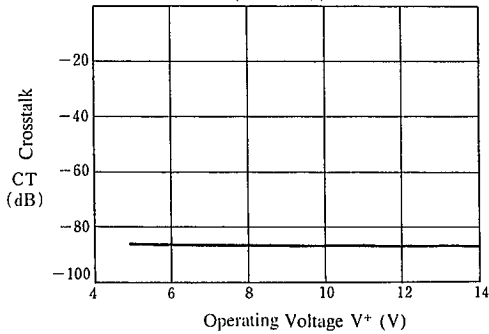

Crosstalk(IN1B to OUT1)vs. Ambient Temperature
($V^+ = 5\text{V}$)

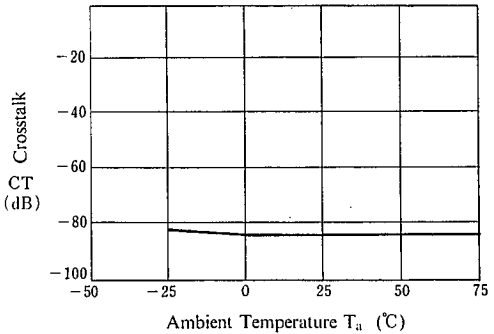

■ TYPICAL CHARACTERISTICS (T_a=+25°C)

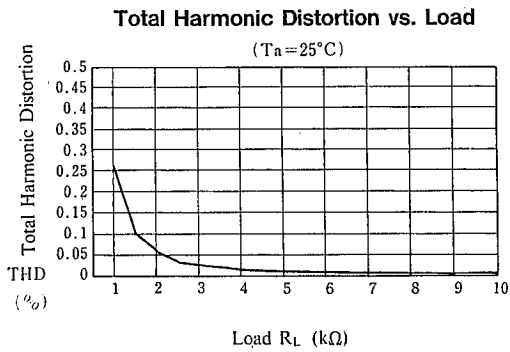

5

MEMO

[CAUTION]

The specifications on this databook are only given for information, without any guarantee as regards either mistakes or omissions. The application circuits in this databook are described only to show representative usages of the product and not intended for the guarantee or permission of any right including the industrial rights.