

ESD Protected to ±15kV, 5V, Low Power, High Speed or Slew Rate Limited, RS-485/RS-422 Transceivers

These Intersil RS-485, RS-422 devices are ESD protected, BiCMOS 5V powered, single transceivers that meet both the RS-485 and RS-422 standards for balanced communication. Each driver output/receiver input is protected against ±15kV ESD strikes, without latch-up. Unlike competitive devices, this Intersil family is specified for 10% tolerance supplies (4.5V to 5.5V).

The ISL8483E utilizes slew rate limited drivers which reduce EMI, and minimize reflections from improperly terminated transmission lines, or un-terminated stubs in multidrop and multipoint applications.

Data rates up to 10Mbps are achievable by using the ISL8485E which features higher slew rates.

Both devices present a “single unit load” to the RS-485 bus, which allows up to 32 transceivers on the network.

Receiver (Rx) inputs feature a “fail-safe if open” design, which ensures a logic high Rx output, if Rx inputs are floating.

Driver (Tx) outputs are short circuit protected, even for voltages exceeding the power supply voltage. Additionally, on-chip thermal shutdown circuitry disables the Tx outputs to prevent damage if power dissipation becomes excessive.

These half duplex configurations multiplex the Rx inputs and Tx outputs to allow transceivers with Rx and Tx disable functions in 8 lead packages.

Features

- Pb-Free Available (RoHS Compliant)
- Military and Extended Industrial Temperature Options (+125°C)
- RS-485 I/O Pin ESD Protection ±15kV HBM
 - Class 3 ESD Level on all Other Pins >7kV HBM
- Specified for 10% Tolerance Supplies
- High Data Rate Version (ISL8485E) up to 10Mbps
- Slew Rate Limited Version for Error Free Data Transmission (ISL8483E) up to 250kbps
- Single Unit Load Allows up to 32 Devices on the Bus
- 1nA Low Current Shutdown Mode (ISL8483E)
- Low Quiescent Current:
 - 160µA (ISL8483E)
 - 500µA (ISL8485E)
- -7V to +12V Common Mode Input Voltage Range
- Three State Rx and Tx Outputs
- 30ns Propagation Delays, 5ns Skew (ISL8485E)
- Operate from a Single +5V Supply (10% Tolerance)
- Current Limiting and Thermal Shutdown for driver Overload Protection

Applications

- Factory Automation
- Security Networks
- Building Environmental Control Systems
- Industrial/Process Control Networks
- Level Translators (e.g., RS-232 to RS-422)
- RS-232 “Extension Cords”

TABLE 1. SUMMARY OF FEATURES

PART NUMBER	HALF/FULL DUPLEX	MIL TEMP?	NO. OF DEVICES ALLOWED ON BUS	DATA RATE (Mbps)	SLEW-RATE LIMITED?	RECEIVER/DRIVER ENABLE?	QUIESCENT I _{CC} (µA)	LOW POWER SHUTDOWN?	PIN COUNT
ISL8483E	Half	No	32	0.25	Yes	Yes	160	Yes	8
ISL8485E	Half	Yes	32	10	No	Yes	500	No	8

Pinout

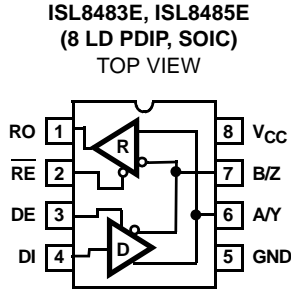

Truth Tables

TRANSMITTING

INPUTS			OUTPUTS	
\overline{RE}	DE	DI	Z	Y
X	1	1	0	1
X	1	0	1	0
0	0	X	High-Z	High-Z
1	0	X	High-Z *	High-Z *

*Shutdown Mode for ISL8483E (see Note 7)

RECEIVING

INPUTS			OUTPUT
\overline{RE}	DE	A-B	RO
0	0	$\geq +0.2V$	1
0	0	$\leq -0.2V$	0
0	0	Inputs Open	1
1	0	X	High-Z*
1	1	X	High-Z

*Shutdown Mode for ISL8483E (see Note 7)

Ordering Information

PART NUMBER	PART MARKING	TEMP. RANGE (°C)	PACKAGE	PKG. DWG. #
ISL8483ECPZ (Note)	ISL8483ECPZ	-0 to +70	8 Ld PDIP* (Pb-free)	E8.3
ISL8483EIB**	8483EIB	-40 to +85	8 Ld SOIC	M8.15
ISL8483EIBZ** (Note)	8483EIBZ	-40 to +85	8 Ld SOIC (Pb-free)	M8.15
ISL8483EIP	ISL8483EIP	-40 to +85	8 Ld PDIP	E8.3
ISL8483EIPZ (Note)	ISL8483EIPZ	-40 to +85	8 Ld PDIP* (Pb-free)	E8.3
ISL8485EABZ** (Note)	8485EABZ	-40 to +125	8 Ld SOIC (Pb-free)	M8.15
ISL8485ECB**	8485ECB	0 to +70	8 Ld SOIC	M8.15
ISL8485ECBZ** (Note)	8485ECBZ	0 to +70	8 Ld SOIC (Pb-free)	M8.15
ISL8485ECP	ISL8485ECP	0 to +70	8 Ld PDIP	E8.3
ISL8485ECPZ (Note)	ISL8485ECPZ	0 to +70	8 Ld PDIP* (Pb-free)	E8.3
ISL8485EIB**	8485EIB	-40 to +85	8 Ld SOIC	M8.15
ISL8485EIBZ** (Note)	8485EIBZ	-40 to +85	8 Ld SOIC (Pb-free)	M8.15
ISL8485EIP	ISL8485EIP	-40 to +85	8 Ld PDIP	E8.3
ISL8485EIPZ (Note)	ISL8485EIPZ	-40 to +85	8 Ld PDIP* (Pb-free)	E8.3
ISL8485EMPZ (Note)	ISL8485EMPZ	-55 to +125	8 Ld PDIP* (Pb-free)	E8.3

*Pb-free PDIPs can be used for through hole wave solder processing only. They are not intended for use in Reflow solder processing applications.

**Add "-T" suffix for tape and reel. Please refer to TB347 for details on reel specifications

NOTE: These Intersil Pb-free plastic packaged products employ special Pb-free material sets; molding compounds/die attach materials and 100% matte tin plate plus anneal- (e3 termination finish, which is RoHS compliant and compatible with both SnPb and Pb-free soldering operations). Intersil Pb-free products are MSL classified at Pb-free peak reflow temperatures that meet or exceed the Pb-free requirements of IPC/JEDEC J STD-020.

Pin Descriptions

PIN	FUNCTION
RO	Receiver output: If $A > B$ by at least 0.2V, RO is high; If $A < B$ by 0.2V or more, RO is low; RO = High if A and B are unconnected (floating).
\overline{RE}	Receiver output enable. RO is enabled when \overline{RE} is low; RO is high impedance when \overline{RE} is high.
DE	Driver output enable. The driver outputs, Y and Z, are enabled by bringing DE high. They are high impedance when DE is low.
DI	Driver input. A low on DI forces output Y low and output Z high. Similarly, a high on DI forces output Y high and output Z low.
GND	Ground connection.
A/Y	$\pm 15kV$ HBM ESD Protected, RS485, RS4-422 level noninverting receiver input and noninverting driver output. Pin is an input (A) if $DE = 0$; pin is an output (Y) if $DE = 1$.
B/Z	$\pm 15kV$ HBM ESD Protected, RS485, RS4-422 level inverting receiver input and inverting driver output. Pin is an input (B) if $DE = 0$; pin is an output (Z) if $DE = 1$.
VCC	System power supply input (4.5V to 5.5V).

Typical Operating Circuits

ISL8483E, ISL8485E

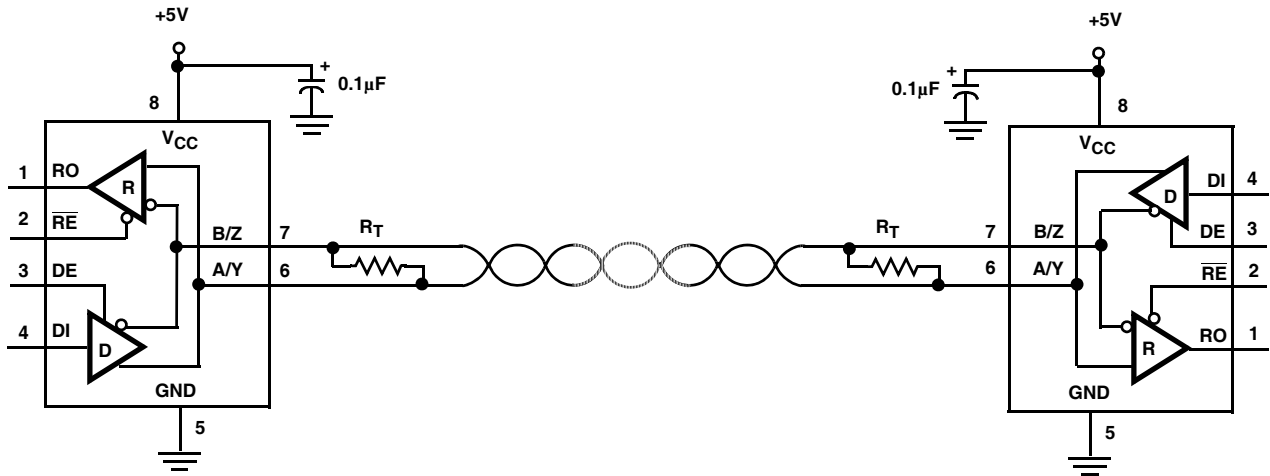

ISL8483E, ISL8485E

Absolute Maximum Ratings

V _{CC} to Ground	7V
Input Voltages	
DI, DE, RE	-0.5V to (V _{CC} +0.5V)
Input/Output Voltages	
A/Y, B/Z	-8V to +12.5V
RO	-0.5V to (V _{CC} +0.5V)
Short Circuit Duration	
Y, Z	Continuous
ESD Rating	See Specification Table

Operating Conditions

Temperature Range	
ISL8485ECx	0°C to +70°C
ISL848xElx	-40°C to +85°C
ISL8485EAx	-40°C to +125°C
ISL8485EMx	-55°C to +125°C

CAUTION: Do not operate at or near the maximum ratings listed for extended periods of time. Exposure to such conditions may adversely impact product reliability and result in failures not covered by warranty.

NOTE:

1. θ_{JA} is measured with the component mounted on a low effective thermal conductivity test board in free air. See Tech Brief TB379 for details.

Thermal Information

Thermal Resistance (Typical, Note 1)	θ_{JA} (°C/W)
8 Ld SOIC Package	170
8 Ld PDIP Package*	140
Maximum Junction Temperature (Plastic Package)	+150°C
Maximum Storage Temperature Range	-65°C to +150°C
Pb-free reflow profile	see link below
http://www.intersil.com/pbfree/Pb-FreeReflow.asp	
*Pb-free PDIPs can be used for through hole wave solder processing only. They are not intended for use in reflow solder processing applications.	

Electrical Specifications

Test Conditions: V_{CC} = 4.5V to 5.5V; Unless Otherwise Specified.
Typicals are at V_{CC} = 5V, T_A = +25°C, (Note 2)

PARAMETER	SYMBOL	TEST CONDITIONS	TEMP (°C)	MIN (Note 12)	TYP	MAX (Note 12)	UNITS	
DC CHARACTERISTICS								
Driver Differential V _{OUT} (no load)	V _{OD1}		Full	-	-	V _{CC}	V	
Driver Differential V _{OUT} (with load)	V _{OD2}	R = 50Ω (RS-422), (Figure 1)	Full	2	3	-	V	
		R = 27Ω (RS-485), (Figure 1)	Full	1.5	2.3	5	V	
Change in Magnitude of Driver Differential V _{OUT} for Complementary Output States	ΔV _{OD}	R = 27Ω or 50Ω, (Figure 1)	Full	-	0.01	0.2	V	
Driver Common-Mode V _{OUT}	V _{OC}	R = 27Ω or 50Ω, (Figure 1)	Full	-	-	3	V	
Change in Magnitude of Driver Common-Mode V _{OUT} for Complementary Output States	ΔV _{OC}	R = 27Ω or 50Ω, (Figure 1)	Full	-	0.01	0.2	V	
Logic Input High Voltage	V _{IH}	DE, DI, RE	Full	2	-	-	V	
Logic Input Low Voltage	V _{IL}	DE, DI, RE	Full	-	-	0.8	V	
Logic Input Current	I _{IN1}	DE, DI, RE (ISL8483E)	Full	-2	-	2	μA	
	I _{IN1}	DI (ISL8485E)	Full	-2	-	2	μA	
	I _{IN1}	DE, RE (ISL8485E)	Full	-25	-	25	μA	
Input Current (A, B), (Note 10)	I _{IN2}	DE = 0V, V _{CC} = 0V or 4.5 to 5.5V	V _{IN} = 12V	Full	-	-	1	mA
			V _{IN} = -7V	Full	-	-	-0.8	mA
Receiver Differential Threshold Voltage	V _{TH}	-7V ≤ V _{CM} ≤ 12V	Full	-0.2	-	0.2	V	
Receiver Input Hysteresis	ΔV _{TH}	V _{CM} = 0V	25	-	70	-	mV	
Receiver Output High Voltage	V _{OH}	I _O = -4mA, V _{ID} = 200mV	Full	3.5	-	-	V	
Receiver Output Low Voltage	V _{OL}	I _O = -4mA, V _{ID} = 200mV	Full	-	-	0.4	V	
Three-State (high impedance) Receiver Output Current	I _{OZR}	0.4V ≤ V _O ≤ 2.4V	Full	-	-	±1	μA	
Receiver Input Resistance	R _{IN}	-7V ≤ V _{CM} ≤ 12V	Full	12	-	-	kΩ	

ISL8483E, ISL8485E

Electrical Specifications Test Conditions: $V_{CC} = 4.5V$ to $5.5V$; Unless Otherwise Specified.
Typicals are at $V_{CC} = 5V$, $T_A = +25^\circ C$, (Note 2) (Continued)

PARAMETER	SYMBOL	TEST CONDITIONS	TEMP (°C)	MIN (Note 12)	TYP	MAX (Note 12)	UNITS	
No-Load Supply Current, (Note 3)	I_{CC}	ISL8485E, DI, $\overline{RE} = 0V$ or V_{CC}	DE = V_{CC}	Full	-	700	900	μA
			DE = 0V	Full	-	500	565	μA
		ISL8483E, DI, $\overline{RE} = 0V$ or V_{CC}	DE = V_{CC}	Full	-	470	650	μA
			DE = 0V	Full	-	160	250	μA
Shutdown Supply Current	I_{SHDN}	ISL8483E, DE = 0V, $\overline{RE} = V_{CC}$, DI = 0V or V_{CC}	Full	-	1	50	nA	
Driver Short-Circuit Current, $V_O =$ High or Low	I_{OSD1}	DE = V_{CC} , $-7V \leq V_Y$ or $V_Z \leq 12V$, (Note 4)	Full	35	-	250	mA	
Receiver Short-Circuit Current	I_{OSR}	$0V \leq V_O \leq V_{CC}$	Full	7	-	85	mA	
SWITCHING CHARACTERISTICS (ISL8485E)								
Driver Input to Output Delay	t_{PLH} , t_{PHL}	$R_{DIFF} = 54\Omega$, $C_L = 100pF$, (Figure 2)	Full	18	30	50	ns	
Driver Output Skew	t_{SKEW}	$R_{DIFF} = 54\Omega$, $C_L = 100pF$, (Figure 2)	Full	-	2	10	ns	
Driver Differential Rise or Fall Time	t_R , t_F	$R_{DIFF} = 54\Omega$, $C_L = 100pF$, (Figure 2)	Full	3	11	25	ns	
Driver Enable to Output High	t_{ZH}	$C_L = 100pF$, SW = GND, (Figure 3)	Full	-	17	70	ns	
Driver Enable to Output Low	t_{ZL}	$C_L = 100pF$, SW = V_{CC} , (Figure 3)	Full	-	14	70	ns	
Driver Disable from Output High	t_{HZ}	$C_L = 15pF$, SW = GND, (Figure 3)	Full	-	19	70	ns	
Driver Disable from Output Low	t_{LZ}	$C_L = 15pF$, SW = V_{CC} , (Figure 3)	Full	-	13	70	ns	
Receiver Input to Output Delay	t_{PLH} , t_{PHL}	(Figure 4)	Full	30	40	150	ns	
Receiver Skew $t_{PLH} - t_{PHL}$	t_{SKD}	(Figure 4)	25	-	5	-	ns	
Receiver Enable to Output High	t_{ZH}	$C_L = 15pF$, SW = GND, (Figure 5)	Full	-	9	50	ns	
Receiver Enable to Output Low	t_{ZL}	$C_L = 15pF$, SW = V_{CC} , (Figure 5)	Full	-	9	50	ns	
Receiver Disable from Output High	t_{HZ}	$C_L = 15pF$, SW = GND, (Figure 5)	Full	-	9	50	ns	
Receiver Disable from Output Low	t_{LZ}	$C_L = 15pF$, SW = V_{CC} , (Figure 5)	Full	-	9	50	ns	
Maximum Data Rate	f_{MAX}	(Note 11)	Full	10	-	-	Mbps	
SWITCHING CHARACTERISTICS (ISL8483E)								
Driver Input to Output Delay	t_{PLH} , t_{PHL}	$R_{DIFF} = 54\Omega$, $C_L = 100pF$, (Figure 2)	Full	250	800	2000	ns	
Driver Output Skew	t_{SKEW}	$R_{DIFF} = 54\Omega$, $C_L = 100pF$, (Figure 2)	Full	-	160	800	ns	
Driver Differential Rise or Fall Time	t_R , t_F	$R_{DIFF} = 54\Omega$, $C_L = 100pF$, (Figure 2)	Full	250	800	2000	ns	
Driver Enable to Output High	t_{ZH}	$C_L = 100pF$, SW = GND, (Figure 3), (Note 5)	Full	250	-	2000	ns	
Driver Enable to Output Low	t_{ZL}	$C_L = 100pF$, SW = V_{CC} , (Figure 3), (Note 5)	Full	250	-	2000	ns	
Driver Disable from Output High	t_{HZ}	$C_L = 15pF$, SW = GND, (Figure 3)	Full	300	-	3000	ns	
Driver Disable from Output Low	t_{LZ}	$C_L = 15pF$, SW = V_{CC} , (Figure 3)	Full	300	-	3000	ns	
Receiver Input to Output Delay	t_{PLH} , t_{PHL}	(Figure 4)	Full	250	350	2000	ns	
Receiver Skew $t_{PLH} - t_{PHL}$	t_{SKD}	(Figure 4)	25	-	25	-	ns	
Receiver Enable to Output High	t_{ZH}	$C_L = 15pF$, SW = GND, (Figure 5), (Note 6)	Full	-	10	50	ns	
Receiver Enable to Output Low	t_{ZL}	$C_L = 15pF$, SW = V_{CC} , (Figure 5), (Note 6)	Full	-	10	50	ns	
Receiver Disable from Output High	t_{HZ}	$C_L = 15pF$, SW = GND, (Figure 5)	Full	-	10	50	ns	
Receiver Disable from Output Low	t_{LZ}	$C_L = 15pF$, SW = V_{CC} , (Figure 5)	Full	-	10	50	ns	
Maximum Data Rate	f_{MAX}	(Note 11)	Full	250	-	-	kbps	
Time to Shutdown	t_{SHDN}	(Note 7)	Full	50	200	600	ns	
Driver Enable from Shutdown to Output High	$t_{ZH}(SHDN)$	$C_L = 100pF$, SW = GND, (Figure 3), (Notes 7, 8)	Full	-	-	2000	ns	

ISL8483E, ISL8485E

Electrical Specifications Test Conditions: $V_{CC} = 4.5V$ to $5.5V$; Unless Otherwise Specified.
Typicals are at $V_{CC} = 5V$, $T_A = +25^\circ C$, (Note 2) (Continued)

PARAMETER	SYMBOL	TEST CONDITIONS	TEMP (°C)	MIN (Note 12)	TYP	MAX (Note 12)	UNITS
Driver Enable from Shutdown to Output Low	$t_{ZL}(SHDN)$	$C_L = 100pF$, $SW = V_{CC}$, (Figure 5), (Notes 7, 8)	Full	-	-	2000	ns
Receiver Enable from Shutdown to Output High	$t_{ZH}(SHDN)$	$C_L = 15pF$, $SW = GND$, (Figure 5), (Notes 7, 9)	Full	-	-	2500	ns
Receiver Enable from Shutdown to Output Low	$t_{ZL}(SHDN)$	$C_L = 15pF$, $SW = V_{CC}$, (Figure 5), (Notes 7, 9)	Full	-	-	2500	ns
ESD PERFORMANCE							
RS-485 Pins (A/Y, B/Z)		Human Body Model	25	-	± 15	-	kV
All Other Pins			25	-	$>\pm 7$	-	kV

NOTES:

- All currents into device pins are positive; all currents out of device pins are negative. All voltages are referenced to device ground unless otherwise specified.
- Supply current specification is valid for loaded drivers when $DE = 0V$.
- Applies to peak current. See "Typical Performance Curves" on page 10 for more information.
- When testing the ISL8483E, keep $\overline{RE} = 0$ to prevent the device from entering SHDN.
- When testing the ISL8483E, the \overline{RE} signal high time must be short enough (typically $<200ns$) to prevent the device from entering SHDN.
- The ISL8483E is put into shutdown by bringing \overline{RE} high and DE low. If the inputs are in this state for less than 50ns, the parts are guaranteed not to enter shutdown. If the inputs are in this state for at least 600ns, the parts are guaranteed to have entered shutdown. See "Low Power Shutdown Mode (ISL8483E Only)" on page 9.
- Keep $\overline{RE} = V_{CC}$, and set the DE signal low time $>600ns$ to ensure that the device enters SHDN.
- Set the \overline{RE} signal high time $>600ns$ to ensure that the device enters SHDN.
- Devices meeting these limits are denoted as "single unit load (1 UL)" transceivers. The RS-485 standard allows up to 32 Unit Loads on the bus.
- Limits established by characterization and are not production tested.
- Parameters with MIN and/or MAX limits are 100% tested at $+25^\circ C$, unless otherwise specified. Temperature limits established by characterization and are not production tested.

Test Circuits and Waveforms

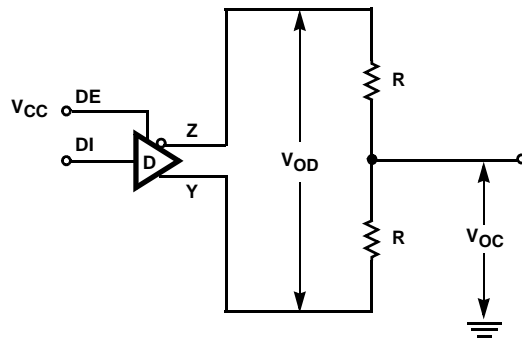

FIGURE 1. DRIVER V_{OD} AND V_{OC}

Test Circuits and Waveforms (Continued)

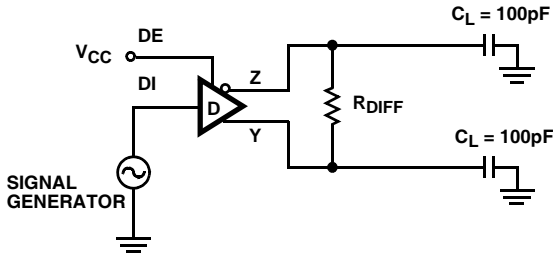
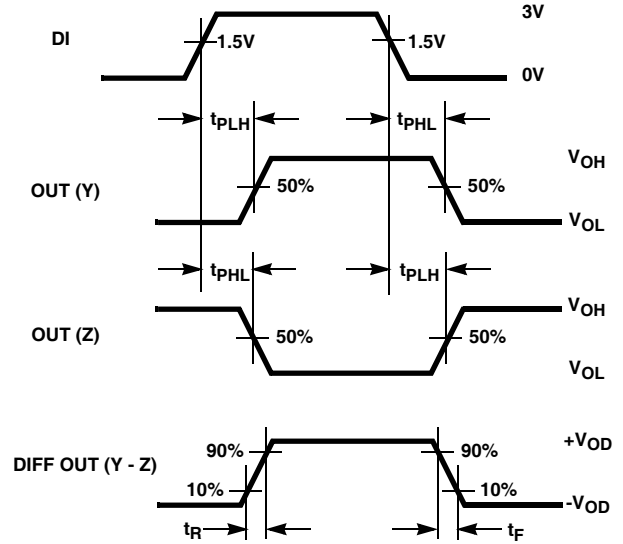

FIGURE 2A. TEST CIRCUIT



$$\text{SKEW} = |t_{PLH}(Y \text{ or } Z) - t_{PHL}(Z \text{ or } Y)|$$

FIGURE 2B. MEASUREMENT POINTS

FIGURE 2. DRIVER PROPAGATION DELAY AND DIFFERENTIAL TRANSITION TIMES

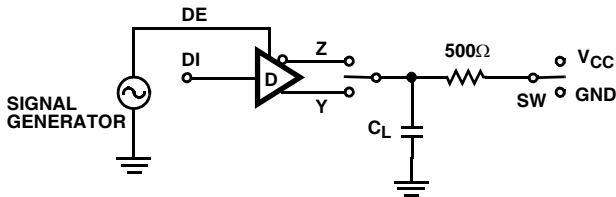

(SHDN) FOR ISL8483E ONLY

PARAMETER	OUTPUT	$\overline{\text{RE}}$	DI	SW	C_L (pF)
t_{HZ}	Y/Z	X	1 / 0	GND	15
t_{LZ}	Y/Z	X	0 / 1	V_{CC}	15
t_{ZH}	Y/Z	0 (Note 5)	1 / 0	GND	100
t_{ZL}	Y/Z	0 (Note 5)	0 / 1	V_{CC}	100
$t_{ZH}(\text{SHDN})$	Y/Z	1 (Note 8)	1 / 0	GND	100
$t_{ZL}(\text{SHDN})$	Y/Z	1 (Note 8)	0 / 1	V_{CC}	100

FIGURE 3A. TEST CIRCUIT

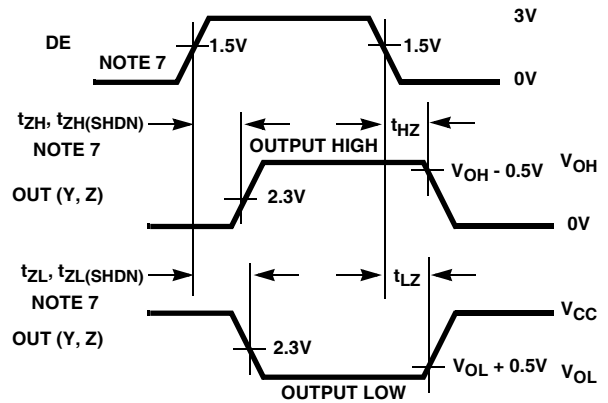

FIGURE 3B. MEASUREMENT POINTS

FIGURE 3. DRIVER ENABLE AND DISABLE TIMES

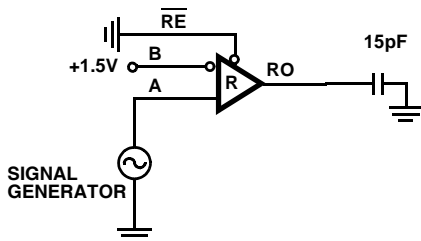

FIGURE 4A. TEST CIRCUIT

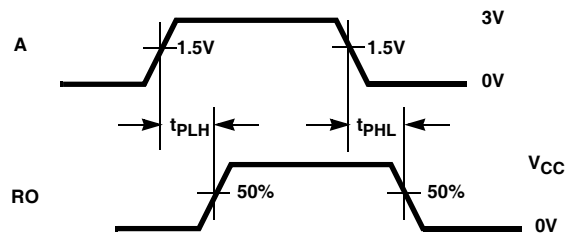
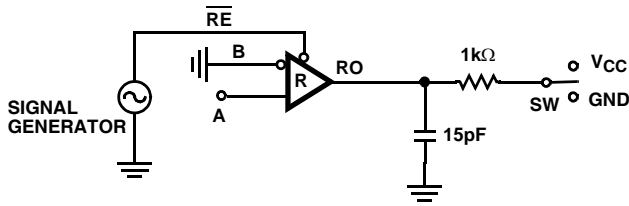

FIGURE 4B. MEASUREMENT POINTS

FIGURE 4. RECEIVER PROPAGATION DELAY

Test Circuits and Waveforms (Continued)



(SHDN) FOR ISL8483E ONLY

PARAMETER	DE	A	SW
t_{HZ}	0	+1.5V	GND
t_{LZ}	0	-1.5V	V_{CC}
t_{ZH} (Note 6)	0	+1.5V	GND
t_{ZL} (Note 6)	0	-1.5V	V_{CC}
$t_{ZH(SHDN)}$ (Note 9)	0	+1.5V	GND
$t_{ZL(SHDN)}$ (Note 9)	0	-1.5V	V_{CC}

FIGURE 5A. TEST CIRCUIT

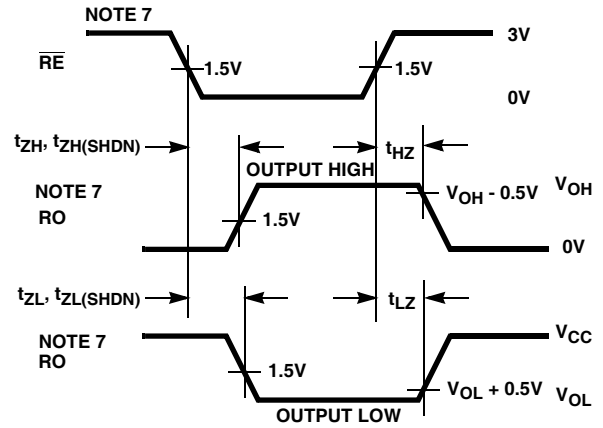

FIGURE 5B. MEASUREMENT POINTS

FIGURE 5. RECEIVER ENABLE AND DISABLE TIMES

Application Information

RS-485 and RS-422 are differential (balanced) data transmission standards for use in long haul or noisy environments. RS-422 is a subset of RS-485, so RS-485 transceivers are also RS-422 compliant. RS-422 is a point-to-multipoint (multidrop) standard, which allows only one driver and up to 10 (assuming one unit load devices) receivers on each bus. RS-485 is a true multipoint standard, which allows up to 32 one unit load devices (any combination of drivers and receivers) on each bus. To allow for multipoint operation, the RS-485 specification requires that drivers must handle bus contention without sustaining any damage.

Another important advantage of RS-485 is the extended common mode range (CMR), which specifies that the driver outputs and receiver inputs withstand signals that range from +12V to -7V. RS-422 and RS-485 are intended for runs as long as 4000 feet, so the wide CMR is necessary to handle ground potential differences, as well as voltages induced in the cable by external fields.

Receiver Features

These devices utilize a differential input receiver for maximum noise immunity and common mode rejection. Input sensitivity is $\pm 200\text{mV}$, as required by the RS422 and RS-485 specifications.

Receiver input impedance surpasses the RS-422 spec of $4\text{k}\Omega$, and meets the RS-485 "Unit Load" requirement of $12\text{k}\Omega$ minimum.

Receiver inputs function with common mode voltages as great as $\pm 7\text{V}$ outside the power supplies (i.e., +12V and -7V), making them ideal for long networks where induced voltages are a realistic concern.

All the receivers include a "fail-safe if open" function that guarantees a high level receiver output if the receiver inputs are unconnected (floating).

Receivers easily meet the data rates supported by the corresponding driver.

ISL8483E, ISL8485E receiver outputs are three-stateable via the active low $\overline{\text{RE}}$ input.

Driver Features

The RS485, RS-422 driver is a differential output device that delivers at least 1.5V across a 54Ω load (RS-485), and at least 2V across a 100Ω load (RS-422). The drivers feature low propagation delay skew to maximize bit width, and to minimize EMI.

Drivers of the ISL8483E, ISL8485E are tri-stateable via the active high DE input.

The ISL8483E driver outputs are slew rate limited to minimize EMI, and to minimize reflections in un-terminated or improperly terminated networks. Data rate on these slew rate limited versions is a maximum of 250kbps. Outputs of the ISL8485E driver are not limited, so faster output transition times allow data rates of at least 10Mbps.

Data Rate, Cables, and Terminations

RS485, RS-422 are intended for network lengths up to 4000 feet, but the maximum system data rate decreases as the transmission length increases. Devices operating at 10Mbps are limited to lengths less than 100 feet, while the 250kbps versions can operate at full data rates with lengths in excess of 1000 feet.

Twisted pair is the cable of choice for RS485, RS-422 networks. Twisted pair cables tend to pick up noise and other electromagnetically induced voltages as common mode signals, which are effectively rejected by the differential receivers in these ICs.

Proper termination is imperative, when using the 10Mbps devices, to minimize reflections. Short networks using the 250kbps versions need not be terminated, but, terminations are recommended unless power dissipation is an overriding concern.

In point-to-point, or point-to-multipoint (single driver on bus) networks, the main cable should be terminated in its characteristic impedance (typically 120Ω) at the end farthest from the driver. In multi-receiver applications, stubs connecting receivers to the main cable should be kept as short as possible. Multipoint (multi-driver) systems require that the main cable be terminated in its characteristic impedance at both ends. Stubs connecting a transceiver to the main cable should be kept as short as possible.

Built-In Driver Overload Protection

As stated previously, the RS-485 specification requires that drivers survive worst case bus contentions undamaged. The ISL848xE devices meet this requirement via driver output short circuit current limits, and on-chip thermal shutdown circuitry.

The driver output stages incorporate short circuit current limiting circuitry which ensures that the output current never exceeds the RS-485 specification, even at the common mode voltage range extremes. Additionally, these devices utilize a foldback circuit which reduces the short circuit current, and thus the power dissipation, whenever the contending voltage exceeds either supply.

In the event of a major short circuit condition, ISL848xE devices also include a thermal shutdown feature that disables the drivers whenever the die temperature becomes excessive. This eliminates the power dissipation, allowing the die to cool. The drivers automatically re-enable after the die temperature drops about 15°. If the contention persists, the thermal shutdown/re-enable cycle repeats until the fault is cleared. Receivers stay operational during thermal shutdown.

Low Power Shutdown Mode (ISL8483E Only)

These CMOS transceivers all use a fraction of the power required by their bipolar counterparts, but the ISL8483E includes a shutdown feature that reduces the already low quiescent I_{CC} to a 1nA trickle. The ISL8483E enters shutdown whenever the receiver and driver are **simultaneously** disabled ($\overline{RE} = V_{CC}$ and $DE = GND$) for a period of at least 600ns. Disabling both the driver and the receiver for less than 50ns guarantees that the ISL8483E will not enter shutdown.

Note that receiver and driver enable times increase when the ISL8483E enables from shutdown. Refer to Notes 5-8, on page 6, at the end of the "Electrical Specifications" table, for more information.

ESD Protection

All pins on these interface devices include class 3 Human Body Model (HBM) ESD protection structures, but the RS-485 pins (driver outputs and receiver inputs) incorporate advanced structures allowing them to survive ESD events in excess of ±15kV HBM. The RS-485 pins are particularly vulnerable to ESD damage because they typically connect to an exposed port on the exterior of the finished product. Simply touching the port pins, or connecting a cable, can cause an ESD event that might destroy unprotected ICs. These new ESD structures protect the device whether or not it is powered up, protect without allowing any latchup mechanism to activate, and without degrading the RS-485 common mode range of -7V to +12V. This built-in ESD protection eliminates the need for board level protection structures (e.g., transient suppression diodes), and the associated, undesirable capacitive load they present.

Human Body Model Testing

As the name implies, this test method emulates the ESD event delivered to an IC during human handling. The tester delivers the charge stored on a 100pF capacitor through a 1.5kΩ current limiting resistor into the pin under test. The HBM method determines an IC's ability to withstand the ESD events typically present during handling and manufacturing.

The RS-485 pin survivability on this high ESD family has been characterized to be in excess of ±15kV, for discharges to GND.

Typical Performance Curves $V_{CC} = 5V$, $T_A = +25^\circ C$, ISL8483E and ISL8485E; Unless Otherwise Specified.

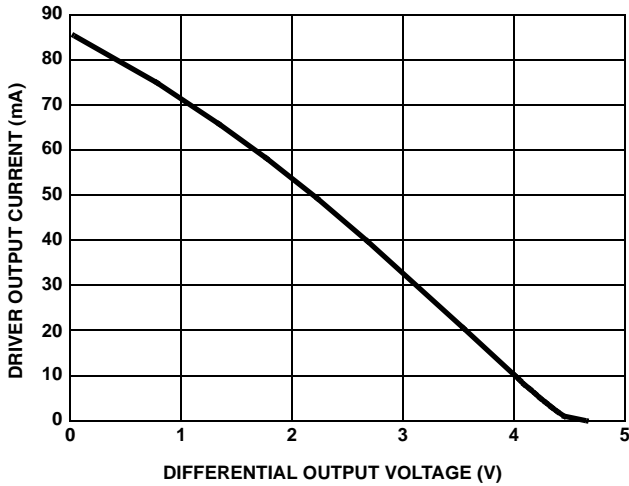

FIGURE 6. DRIVER OUTPUT CURRENT vs DIFFERENTIAL OUTPUT VOLTAGE

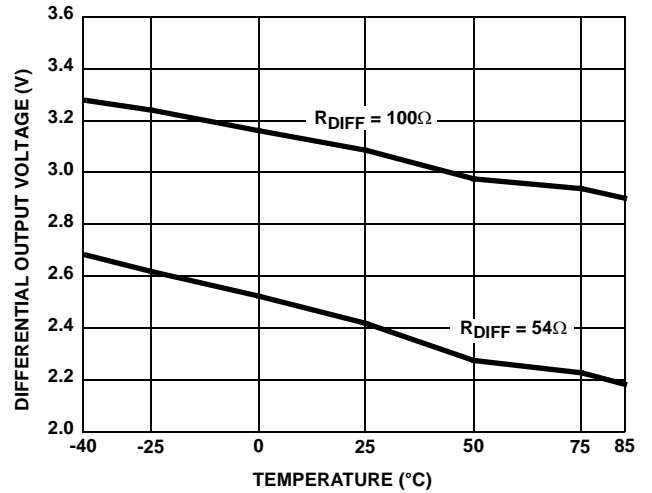

FIGURE 7. DRIVER DIFFERENTIAL OUTPUT VOLTAGE vs TEMPERATURE

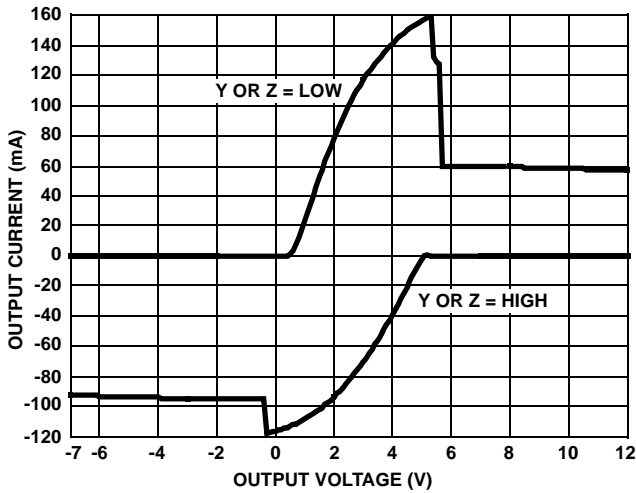

FIGURE 8. DRIVER OUTPUT CURRENT vs SHORT CIRCUIT VOLTAGE

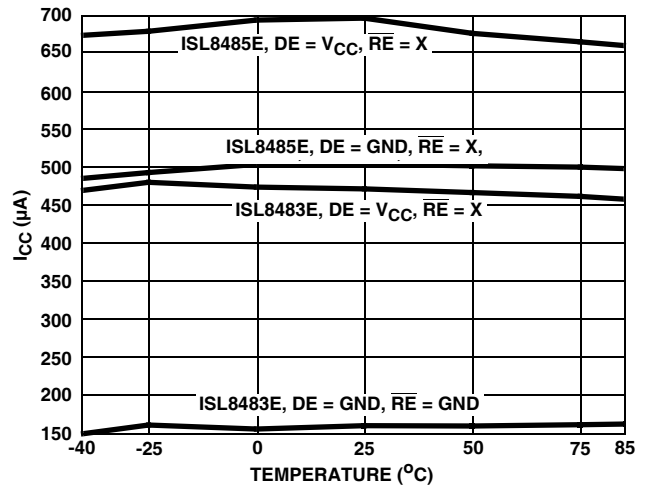

FIGURE 9. SUPPLY CURRENT vs TEMPERATURE

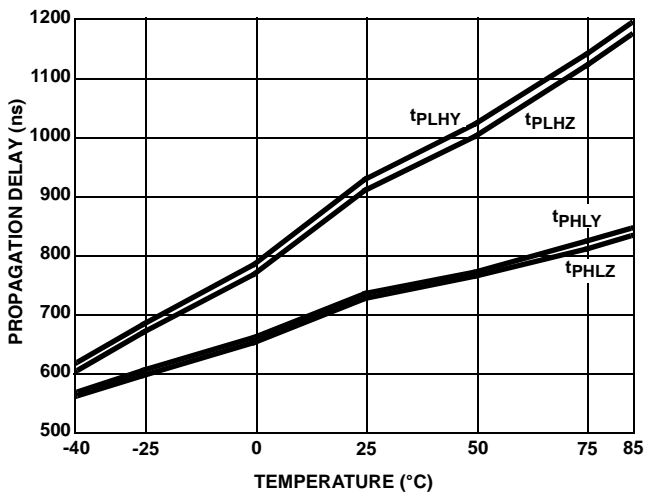

FIGURE 10. DRIVER PROPAGATION DELAY vs TEMPERATURE (ISL8483E)

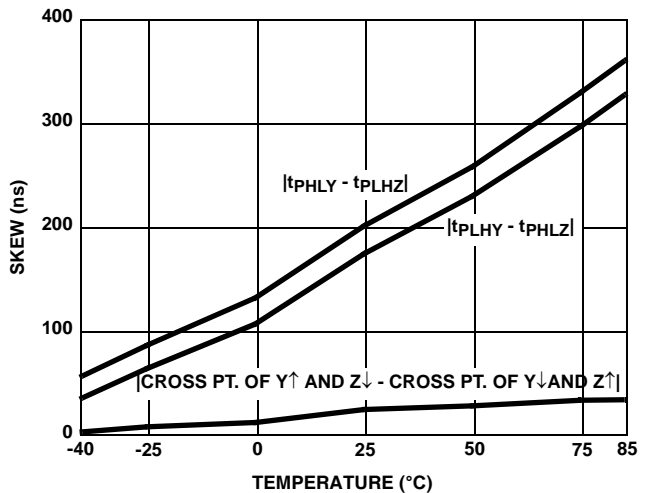

FIGURE 11. DRIVER SKEW vs TEMPERATURE (ISL8483E)

Typical Performance Curves $V_{CC} = 5V, T_A = +25^\circ C$, ISL8483E and ISL8485E; Unless Otherwise Specified. (Continued)

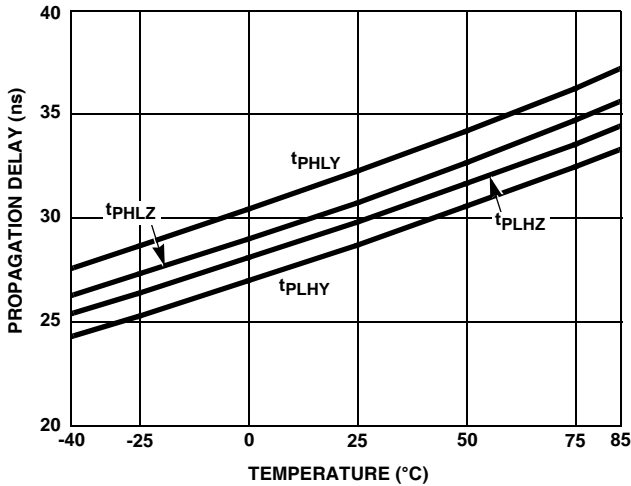

FIGURE 12. DRIVER PROPAGATION DELAY vs TEMPERATURE (ISL8485E)

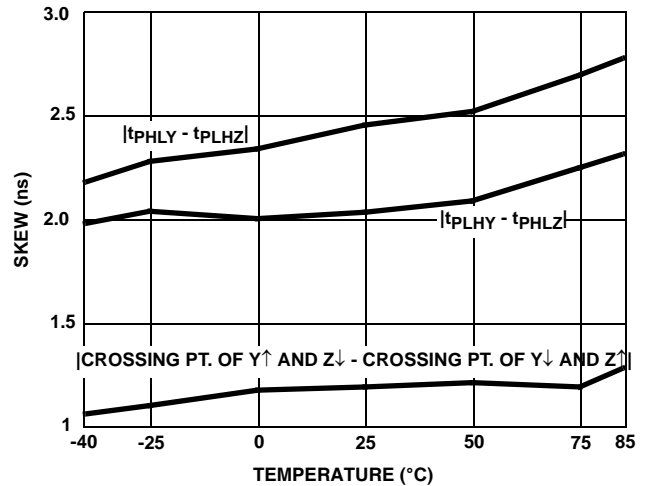

FIGURE 13. DRIVER SKEW vs TEMPERATURE (ISL8485E)

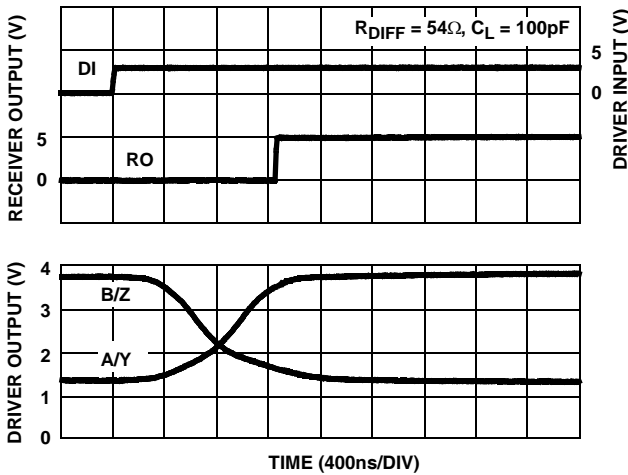

FIGURE 14. DRIVER AND RECEIVER WAVEFORMS, LOW TO HIGH (ISL8483E)

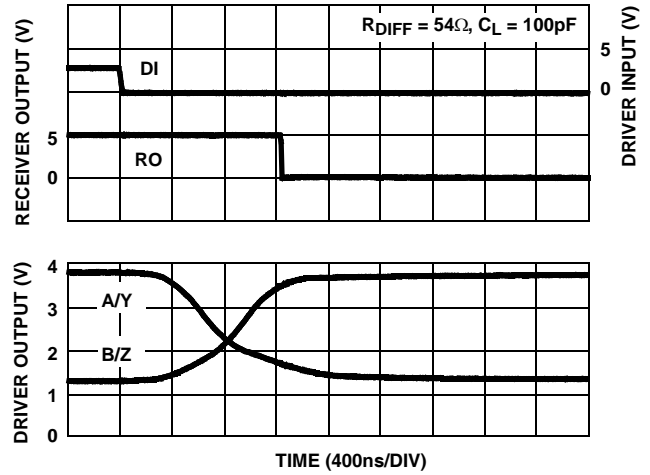

FIGURE 15. DRIVER AND RECEIVER WAVEFORMS, HIGH TO LOW (ISL8483E)

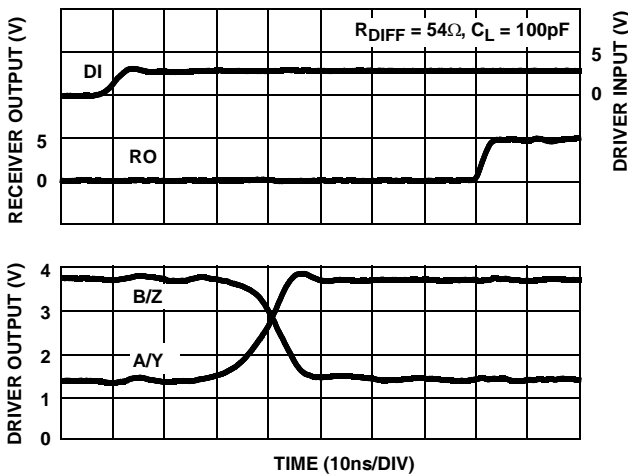

FIGURE 16. DRIVER AND RECEIVER WAVEFORMS, LOW TO HIGH (ISL8485E)

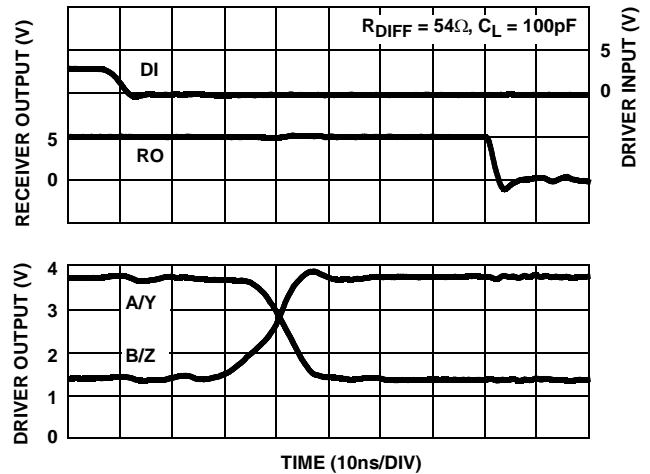

FIGURE 17. DRIVER AND RECEIVER WAVEFORMS, HIGH TO LOW (ISL8485E)

Die Characteristics

SUBSTRATE POTENTIAL (POWERED UP):

GND

TRANSISTOR COUNT:

518

PROCESS:

Si Gate CMOS

Dual-In-Line Plastic Packages (PDIP)

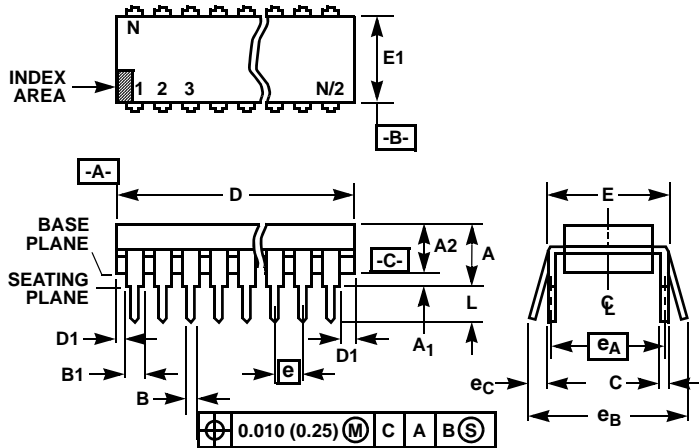

NOTES:

- Controlling Dimensions: INCH. In case of conflict between English and Metric dimensions, the inch dimensions control.
- Dimensioning and tolerancing per ANSI Y14.5M-1982.
- Symbols are defined in the "MO Series Symbol List" in Section 2.2 of Publication No. 95.
- Dimensions A, A1 and L are measured with the package seated in JEDEC seating plane gauge GS-3.
- D, D1, and E1 dimensions do not include mold flash or protrusions. Mold flash or protrusions shall not exceed 0.010 inch (0.25mm).
- E and e_A are measured with the leads constrained to be perpendicular to datum $-C-$.
- e_B and e_C are measured at the lead tips with the leads unconstrained. e_C must be zero or greater.
- B1 maximum dimensions do not include dambar protrusions. Dambar protrusions shall not exceed 0.010 inch (0.25mm).
- N is the maximum number of terminal positions.
- Corner leads (1, N, N/2 and N/2 + 1) for E8.3, E16.3, E18.3, E28.3, E42.6 will have a B1 dimension of 0.030 - 0.045 inch (0.76 - 1.14mm).

E8.3 (JEDEC MS-001-BA ISSUE D)
8 LEAD DUAL-IN-LINE PLASTIC PACKAGE

SYMBOL	INCHES		MILLIMETERS		NOTES
	MIN	MAX	MIN	MAX	
A	-	0.210	-	5.33	4
A1	0.015	-	0.39	-	4
A2	0.115	0.195	2.93	4.95	-
B	0.014	0.022	0.356	0.558	-
B1	0.045	0.070	1.15	1.77	8, 10
C	0.008	0.014	0.204	0.355	-
D	0.355	0.400	9.01	10.16	5
D1	0.005	-	0.13	-	5
E	0.300	0.325	7.62	8.25	6
E1	0.240	0.280	6.10	7.11	5
e	0.100 BSC		2.54 BSC		-
e_A	0.300 BSC		7.62 BSC		6
e_B	-	0.430	-	10.92	7
L	0.115	0.150	2.93	3.81	4
N	8		8		9

Rev. 0 12/93

Small Outline Plastic Packages (SOIC)

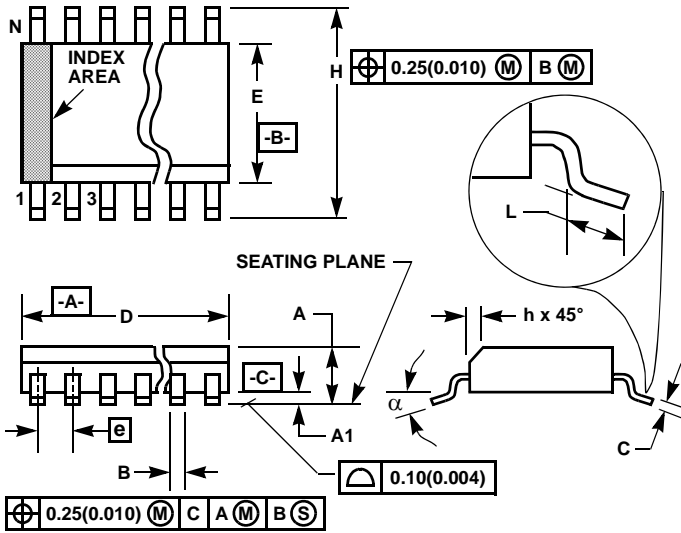

M8.15 (JEDEC MS-012-AA ISSUE C)
8 LEAD NARROW BODY SMALL OUTLINE PLASTIC PACKAGE

SYMBOL	INCHES		MILLIMETERS		NOTES
	MIN	MAX	MIN	MAX	
A	0.0532	0.0688	1.35	1.75	-
A1	0.0040	0.0098	0.10	0.25	-
B	0.013	0.020	0.33	0.51	9
C	0.0075	0.0098	0.19	0.25	-
D	0.1890	0.1968	4.80	5.00	3
E	0.1497	0.1574	3.80	4.00	4
e	0.050 BSC		1.27 BSC		-
H	0.2284	0.2440	5.80	6.20	-
h	0.0099	0.0196	0.25	0.50	5
L	0.016	0.050	0.40	1.27	6
N	8		8		7
α	0°	8°	0°	8°	-

NOTES:

1. Symbols are defined in the "MO Series Symbol List" in Section 2.2 of Publication Number 95.
2. Dimensioning and tolerancing per ANSI Y14.5M-1982.
3. Dimension "D" does not include mold flash, protrusions or gate burrs. Mold flash, protrusion and gate burrs shall not exceed 0.15mm (0.006 inch) per side.
4. Dimension "E" does not include interlead flash or protrusions. Interlead flash and protrusions shall not exceed 0.25mm (0.010 inch) per side.
5. The chamfer on the body is optional. If it is not present, a visual index feature must be located within the crosshatched area.
6. "L" is the length of terminal for soldering to a substrate.
7. "N" is the number of terminal positions.
8. Terminal numbers are shown for reference only.
9. The lead width "B", as measured 0.36mm (0.014 inch) or greater above the seating plane, shall not exceed a maximum value of 0.61mm (0.024 inch).
10. Controlling dimension: MILLIMETER. Converted inch dimensions are not necessarily exact.

Rev. 1 6/05

All Intersil U.S. products are manufactured, assembled and tested utilizing ISO9000 quality systems.
Intersil Corporation's quality certifications can be viewed at www.intersil.com/design/quality

Intersil products are sold by description only. Intersil Corporation reserves the right to make changes in circuit design, software and/or specifications at any time without notice. Accordingly, the reader is cautioned to verify that data sheets are current before placing orders. Information furnished by Intersil is believed to be accurate and reliable. However, no responsibility is assumed by Intersil or its subsidiaries for its use; nor for any infringements of patents or other rights of third parties which may result from its use. No license is granted by implication or otherwise under any patent or patent rights of Intersil or its subsidiaries.

For information regarding Intersil Corporation and its products, see www.intersil.com