

Low Loss DuoPack : IGBT in Trench and Fieldstop technology
with soft, fast recovery anti-parallel EmCon HE diode

- Approx. 1.0V reduced $V_{CE(sat)}$ and 0.5V reduced V_F compared to BUP313D
- Short circuit withstand time – 10 μ s
- Designed for :
 - Frequency Converters
 - Uninterrupted Power Supply
- Trench and Fieldstop technology for 1200 V applications offers :
 - very tight parameter distribution
 - high ruggedness, temperature stable behavior
- NPT technology offers easy parallel switching capability due to positive temperature coefficient in $V_{CE(sat)}$
- Low EMI
- Low Gate Charge
- Very soft, fast recovery anti-parallel EmCon HE diode
- Complete product spectrum and PSpice Models : <http://www.infineon.com/igbt/>

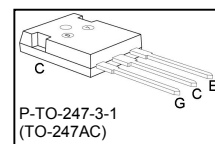
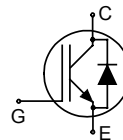

Type	V_{CE}	I_C	$V_{CE(sat), T_j=25^\circ C}$	$T_{j,max}$	Package	Ordering Code
IKW15T120	1200V	15A	1.7V	150°C	TO-247AC	Q67040-S4516

Maximum Ratings

Parameter	Symbol	Value	Unit
Collector-emitter voltage	V_{CE}	1200	V
DC collector current	I_C	30	A
$T_C = 25^\circ C$		15	
$T_C = 100^\circ C$			
Pulsed collector current, t_p limited by T_{jmax}	I_{Cpuls}	45	
Turn off safe operating area	-	45	
$V_{CE} \leq 1200V, T_j \leq 150^\circ C$			
Diode forward current	I_F	30	
$T_C = 25^\circ C$		15	
$T_C = 100^\circ C$			
Diode pulsed current, t_p limited by T_{jmax}	I_{Fpuls}	45	
Gate-emitter voltage	V_{GE}	± 20	V
Short circuit withstand time ¹⁾	t_{SC}	10	μ s
$V_{GE} = 15V, V_{CC} \leq 1200V, T_j \leq 150^\circ C$			
Power dissipation	P_{tot}	110	W
$T_C = 25^\circ C$			
Operating junction temperature	T_j	-40...+150	°C
Storage temperature	T_{stg}	-55...+150	
Soldering temperature, 1.6mm (0.063 in.) from case for 10s	-	260	

¹⁾ Allowed number of short circuits: <1000; time between short circuits: >1s.

Thermal Resistance

Parameter	Symbol	Conditions	Max. Value	Unit
Characteristic				
IGBT thermal resistance, junction – case	R_{thJC}		1.1	K/W
Diode thermal resistance, junction – case	R_{thJCD}		1.5	
Thermal resistance, junction – ambient	R_{thJA}	TO-247AC	40	

Electrical Characteristic, at $T_j = 25^\circ\text{C}$, unless otherwise specified

Parameter	Symbol	Conditions	Value			Unit
			min.	typ.	max.	
Static Characteristic						
Collector-emitter breakdown voltage	$V_{(BR)CES}$	$V_{GE}=0V, I_C=0.5mA$	1200	-	-	V
Collector-emitter saturation voltage	$V_{CE(sat)}$	$V_{GE} = 15V, I_C=15A$ $T_j=25^\circ\text{C}$ $T_j=125^\circ\text{C}$ $T_j=150^\circ\text{C}$	- - -	1.7 2.0 2.2	2.2 - -	
Diode forward voltage	V_F	$V_{GE}=0V, I_F=15A$ $T_j=25^\circ\text{C}$ $T_j=125^\circ\text{C}$ $T_j=150^\circ\text{C}$	- - -	1.7 1.7 1.7	2.2 - -	
Gate-emitter threshold voltage	$V_{GE(th)}$	$I_C=0.6mA, V_{CE}=V_{GE}$	5.0	5.8	6.5	
Zero gate voltage collector current	I_{CES}	$V_{CE}=1200V, V_{GE}=0V$ $T_j=25^\circ\text{C}$ $T_j=150^\circ\text{C}$	- -	- -	0.2 2.0	mA
Gate-emitter leakage current	I_{GES}	$V_{CE}=0V, V_{GE}=20V$	-	-	100	
Transconductance	g_{fs}	$V_{CE}=20V, I_C=15A$	-	10	-	S
Integrated gate resistor	R_{Gint}		none			Ω

Dynamic Characteristic

Input capacitance	C_{iss}	$V_{CE}=25V,$	-	1100	-	pF
Output capacitance	C_{oss}	$V_{GE}=0V,$	-	100	-	
Reverse transfer capacitance	C_{rss}	$f=1MHz$	-	50	-	
Gate charge	Q_{Gate}	$V_{CC}=960V, I_C=15A$ $V_{GE}=15V$	-	85	-	nC
Internal emitter inductance measured 5mm (0.197 in.) from case	L_E	TO-247AC	-	-	13	nH
Short circuit collector current ¹⁾	$I_{C(SC)}$	$V_{GE}=15V, t_{SC} \leq 10\mu s$ $V_{CC} = 600V,$ $T_j = 25^\circ C$	-	90	-	A

Switching Characteristic, Inductive Load, at $T_j=25^\circ C$

Parameter	Symbol	Conditions	Value			Unit
			min.	typ.	max.	

IGBT Characteristic

Turn-on delay time	$t_{d(on)}$	$T_j=25^\circ C,$ $V_{CC}=600V, I_C=15A,$ $V_{GE}=-15/15V,$ $R_G=56\Omega,$ $L_\sigma^{2)}=180nH,$ $C_\sigma^{2)}=39pF$ Energy losses include "tail" and diode reverse recovery.	-	50	-	ns
Rise time	t_r		-	30	-	
Turn-off delay time	$t_{d(off)}$		-	520	-	
Fall time	t_f		-	60	-	
Turn-on energy	E_{on}		-	1.3	-	mJ
Turn-off energy	E_{off}		-	1.4	-	
Total switching energy	E_{ts}		-	2.7	-	

Anti-Parallel Diode Characteristic

Diode reverse recovery time	t_{rr}	$T_j=25^\circ C,$	-	140	-	ns
Diode reverse recovery charge	Q_{rr}	$V_R=600V, I_F=15A,$	-	1.9	-	μC
Diode peak reverse recovery current	I_{rrm}	$di_F/dt=600A/\mu s$	-	17	-	A
Diode peak rate of fall of reverse recovery current during t_b	di_{rr}/dt		-	230	-	$A/\mu s$

¹⁾ Allowed number of short circuits: <1000; time between short circuits: >1s.

²⁾ Leakage inductance L_σ and Stray capacity C_σ due to dynamic test circuit in Figure E.

Switching Characteristic, Inductive Load, at $T_j=150^\circ\text{C}$

Parameter	Symbol	Conditions	Value			Unit	
			min.	typ.	max.		
IGBT Characteristic							
Turn-on delay time	$t_{d(on)}$	$T_j=150^\circ\text{C}$, $V_{CC}=600\text{V}$, $I_C=15\text{A}$, $V_{GE}=-15/15\text{V}$, $R_G=56\Omega$ $L_{\sigma}^{(1)}=180\text{nH}$, $C_{\sigma}^{(1)}=39\text{pF}$ Energy losses include "tail" and diode reverse recovery.	-	50	-	ns	
Rise time	t_r		-	35	-		
Turn-off delay time	$t_{d(off)}$		-	600	-		
Fall time	t_f		-	120	-		
Turn-on energy	E_{on}			-	2.0	-	mJ
Turn-off energy	E_{off}			-	2.1	-	
Total switching energy	E_{ts}			-	4.1	-	
Anti-Parallel Diode Characteristic							
Diode reverse recovery time	t_{rr}	$T_j=150^\circ\text{C}$ $V_R=600\text{V}$, $I_F=15\text{A}$, $di_F/dt=600\text{A}/\mu\text{s}$	-	330	-	ns	
Diode reverse recovery charge	Q_{rr}		-	3.4	-	μC	
Diode peak reverse recovery current	I_{rrm}		-	21	-	A	
Diode peak rate of fall of reverse recovery current during t_b	di_{rr}/dt		-	190	-	$\text{A}/\mu\text{s}$	

¹⁾ Leakage inductance L_{σ} and Stray capacity C_{σ} due to dynamic test circuit in Figure E.

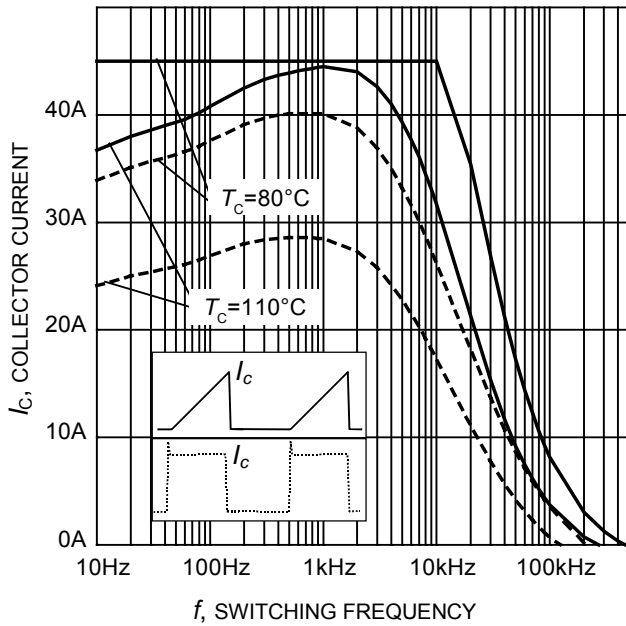

Figure 1. Collector current as a function of switching frequency
 ($T_j \leq 150^\circ\text{C}$, $D = 0.5$, $V_{CE} = 600\text{V}$,
 $V_{GE} = 0/+15\text{V}$, $R_G = 56\Omega$)

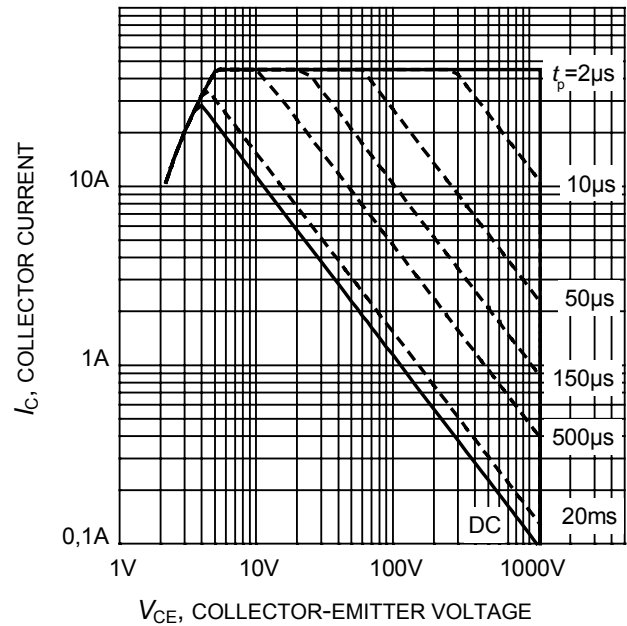

Figure 2. Safe operating area
 ($D = 0$, $T_C = 25^\circ\text{C}$,
 $T_j \leq 150^\circ\text{C}$; $V_{GE} = 15\text{V}$)

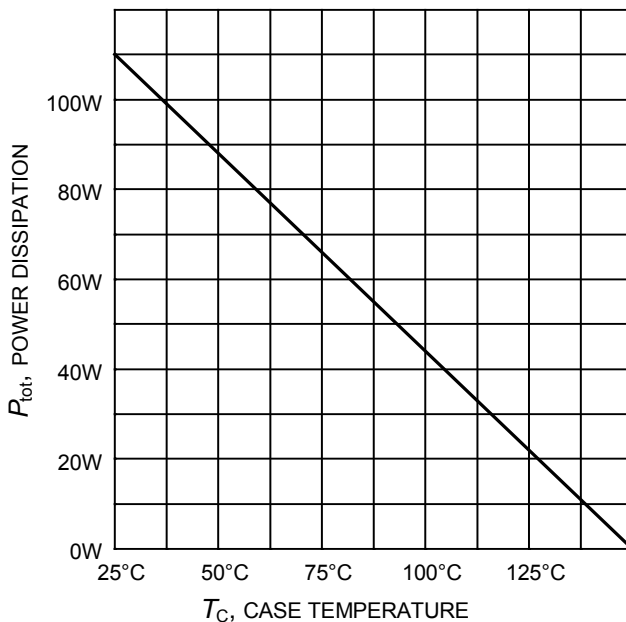

Figure 3. Power dissipation as a function of case temperature
 ($T_j \leq 150^\circ\text{C}$)

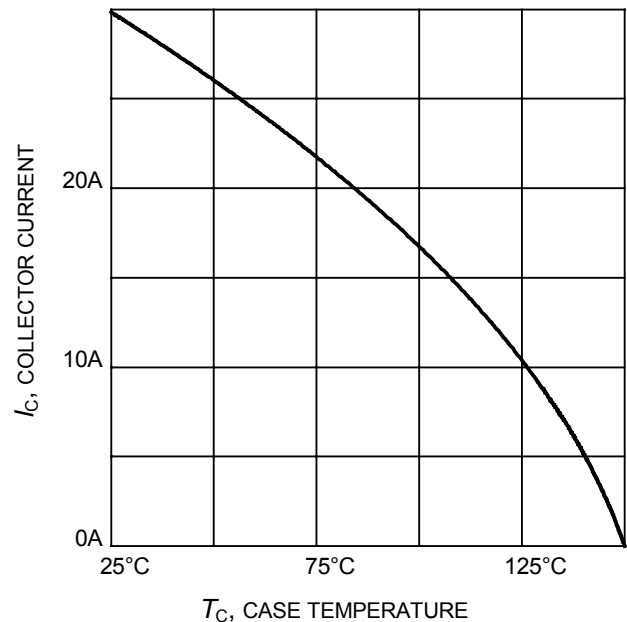

Figure 4. Collector current as a function of case temperature
 ($V_{GE} \geq 15\text{V}$, $T_j \leq 150^\circ\text{C}$)

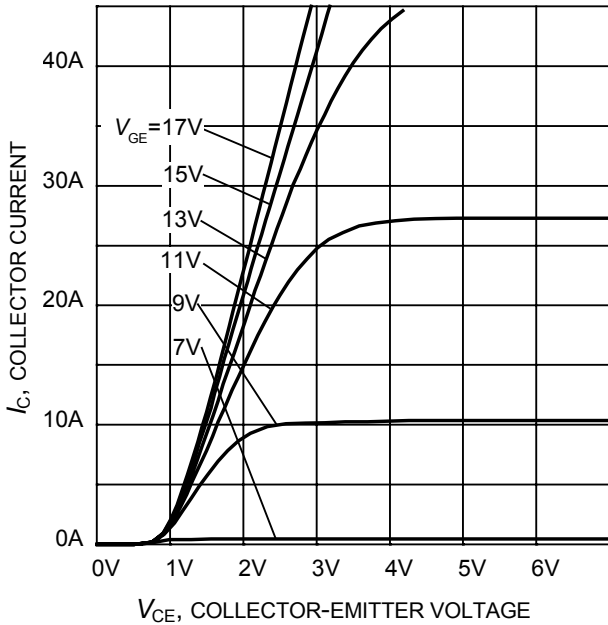

Figure 5. Typical output characteristic
($T_J = 25^\circ\text{C}$)

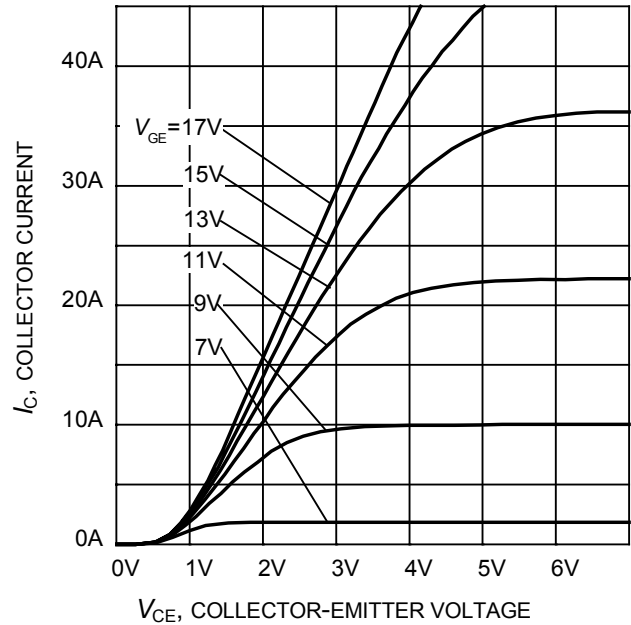

Figure 6. Typical output characteristic
($T_J = 150^\circ\text{C}$)

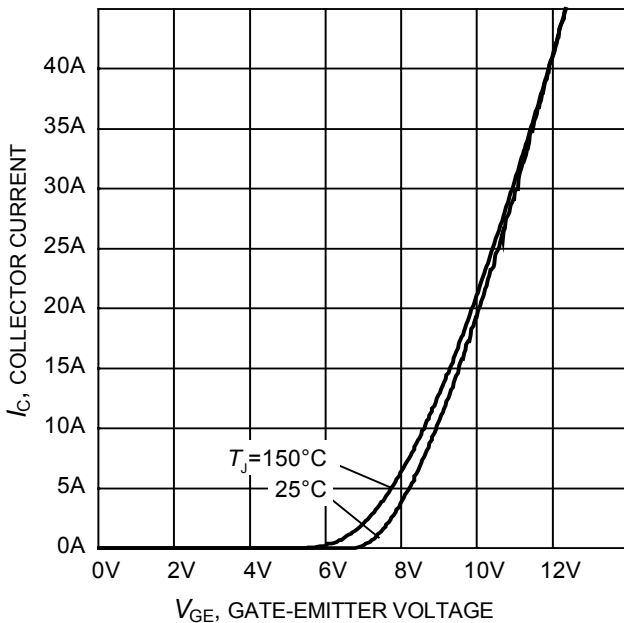

Figure 7. Typical transfer characteristic
($V_{CE} = 20\text{V}$)

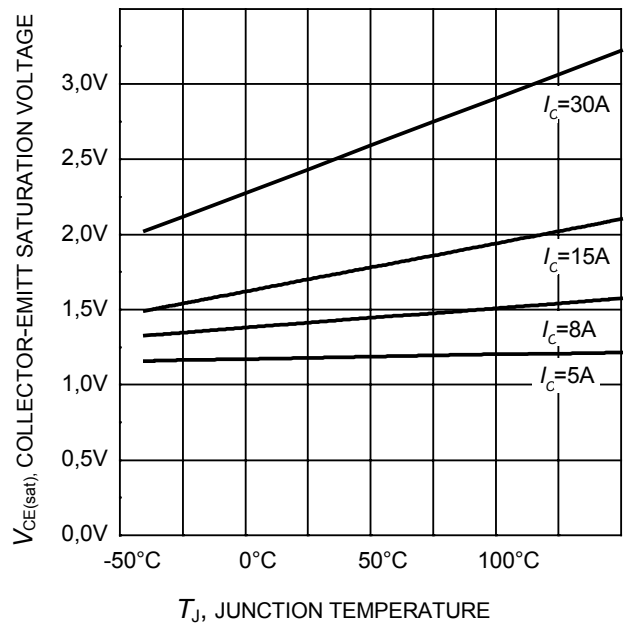

Figure 8. Typical collector-emitter saturation voltage as a function of junction temperature
($V_{GE} = 15\text{V}$)

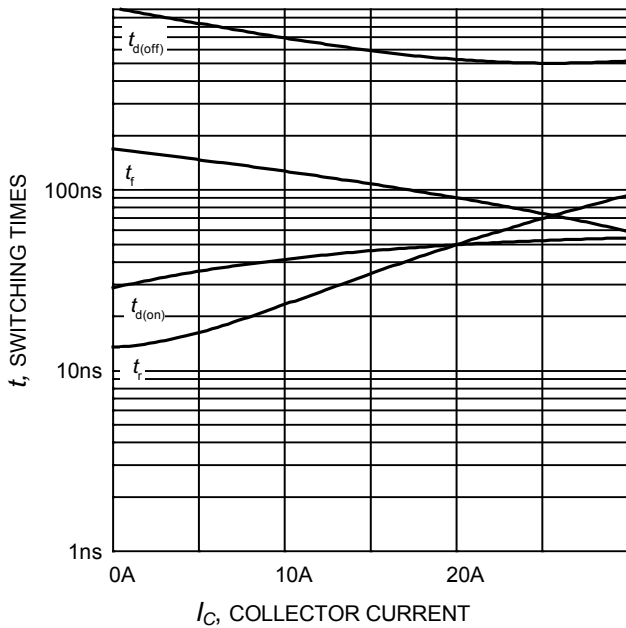

Figure 9. Typical switching times as a function of collector current
(inductive load, $T_J=150^{\circ}\text{C}$, $V_{CE}=600\text{V}$, $V_{GE}=0/15\text{V}$, $R_G=56\Omega$, Dynamic test circuit in Figure E)

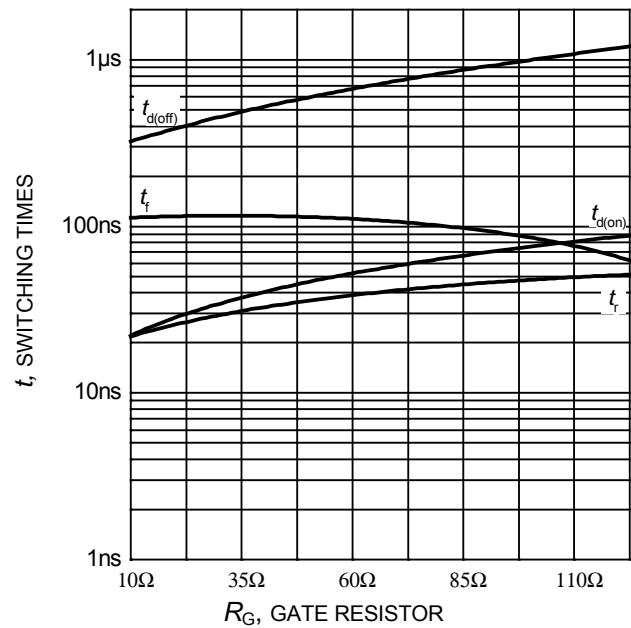

Figure 10. Typical switching times as a function of gate resistor
(inductive load, $T_J=150^{\circ}\text{C}$, $V_{CE}=600\text{V}$, $V_{GE}=0/15\text{V}$, $I_C=15\text{A}$, Dynamic test circuit in Figure E)

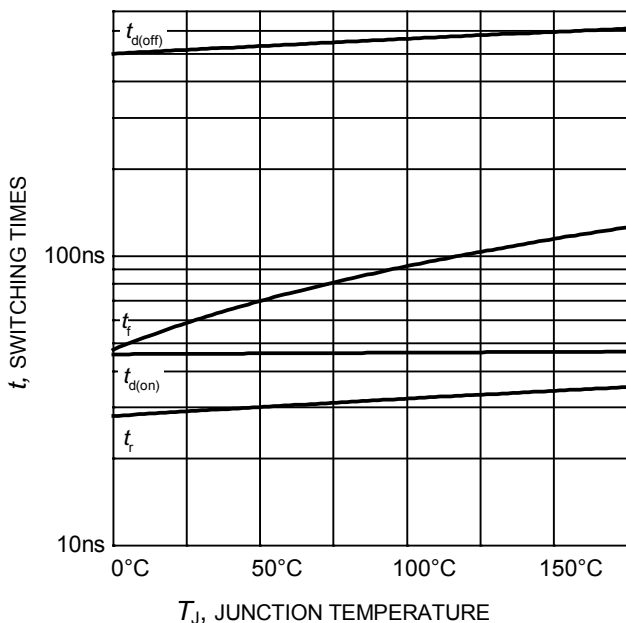

Figure 11. Typical switching times as a function of junction temperature
(inductive load, $V_{CE}=600\text{V}$, $V_{GE}=0/15\text{V}$, $I_C=15\text{A}$, $R_G=56\Omega$, Dynamic test circuit in Figure E)

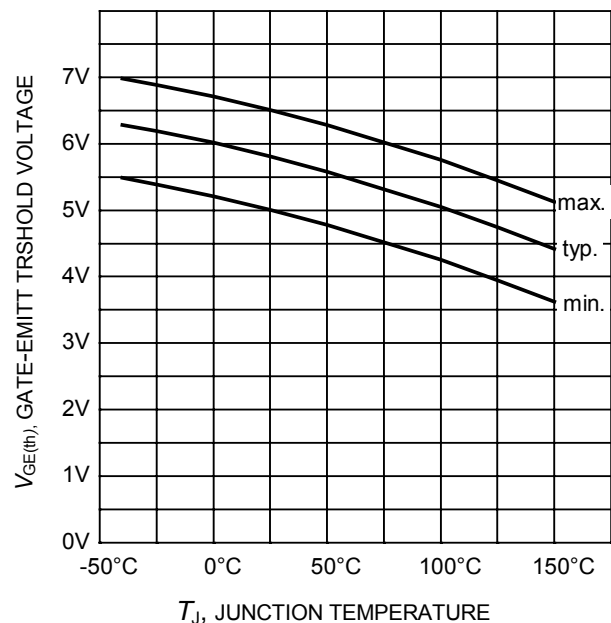

Figure 12. Gate-emitter threshold voltage as a function of junction temperature
($I_C = 0.6\text{mA}$)

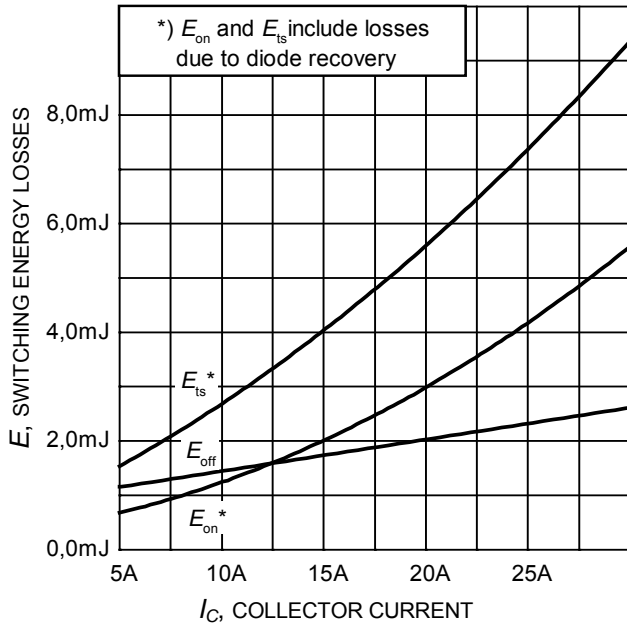

Figure 13. Typical switching energy losses as a function of collector current
 (inductive load, $T_J=150^\circ\text{C}$, $V_{CE}=600\text{V}$, $V_{GE}=0/15\text{V}$, $R_G=56\Omega$, Dynamic test circuit in Figure E)

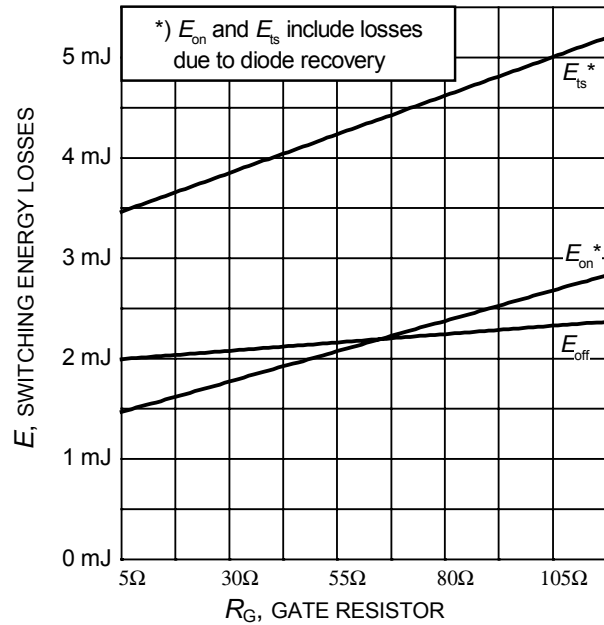

Figure 14. Typical switching energy losses as a function of gate resistor
 (inductive load, $T_J=150^\circ\text{C}$, $V_{CE}=600\text{V}$, $V_{GE}=0/15\text{V}$, $I_C=15\text{A}$, Dynamic test circuit in Figure E)

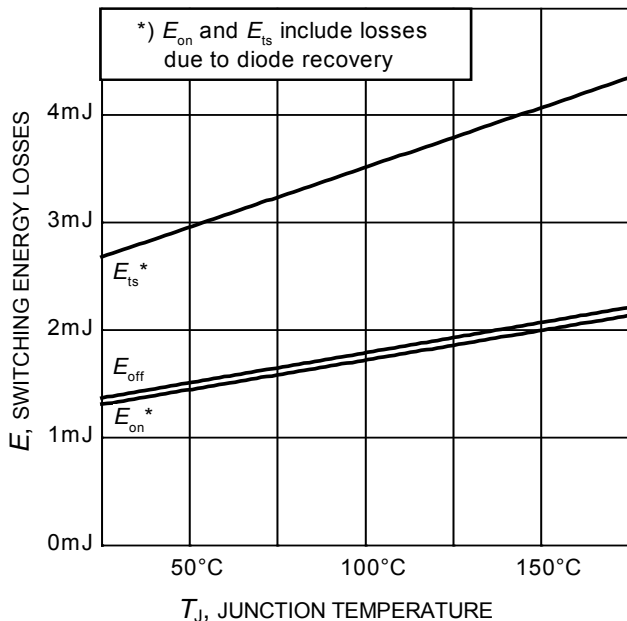

Figure 15. Typical switching energy losses as a function of junction temperature
 (inductive load, $V_{CE}=600\text{V}$, $V_{GE}=0/15\text{V}$, $I_C=15\text{A}$, $R_G=56\Omega$, Dynamic test circuit in Figure E)

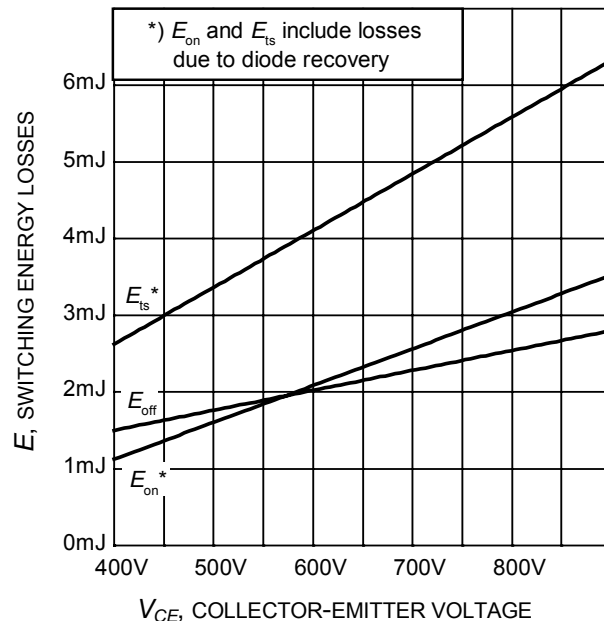

Figure 16. Typical switching energy losses as a function of collector emitter voltage
 (inductive load, $T_J=150^\circ\text{C}$, $V_{GE}=0/15\text{V}$, $I_C=15\text{A}$, $R_G=56\Omega$, Dynamic test circuit in Figure E)

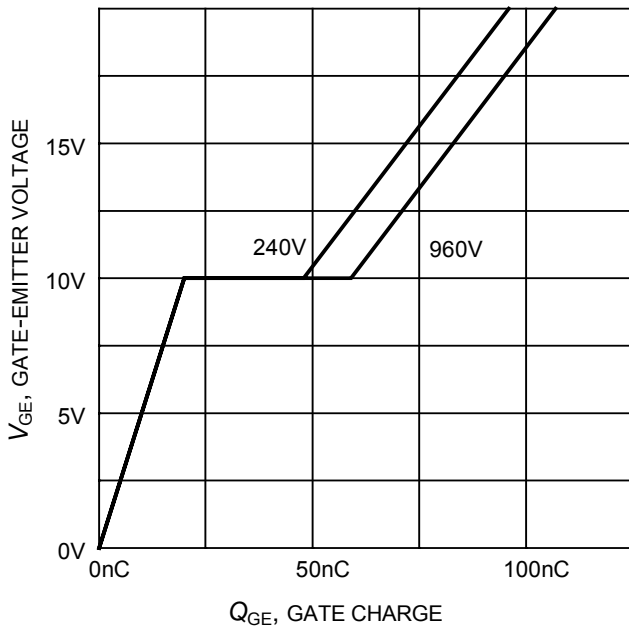

Figure 17. Typical gate charge
($I_C=15\text{ A}$)

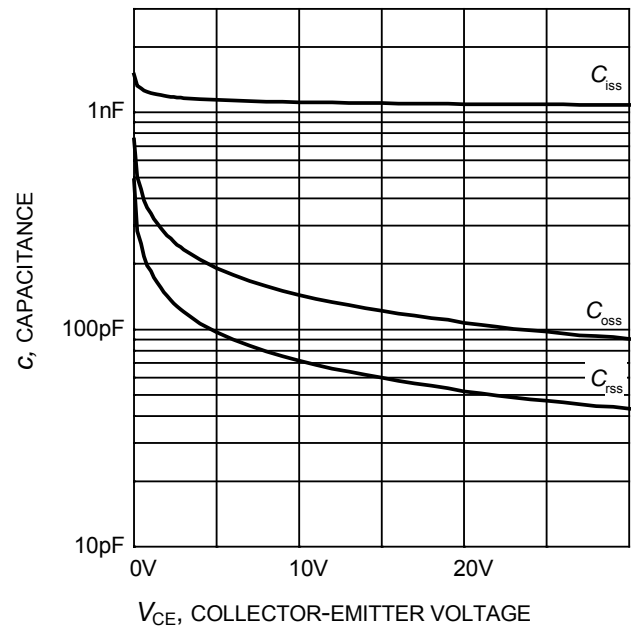

Figure 18. Typical capacitance as a function of collector-emitter voltage
($V_{GE}=0\text{V}$, $f = 1\text{ MHz}$)

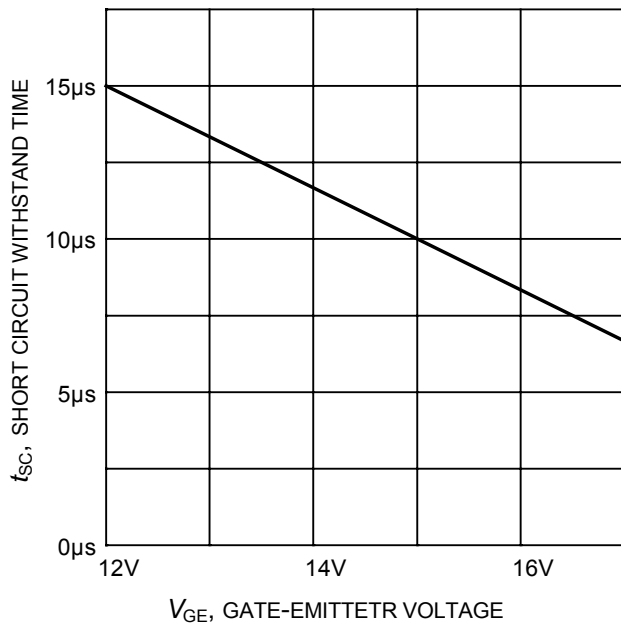

Figure 19. Short circuit withstand time as a function of gate-emitter voltage
($V_{CE}=600\text{V}$, start at $T_j=25^\circ\text{C}$)

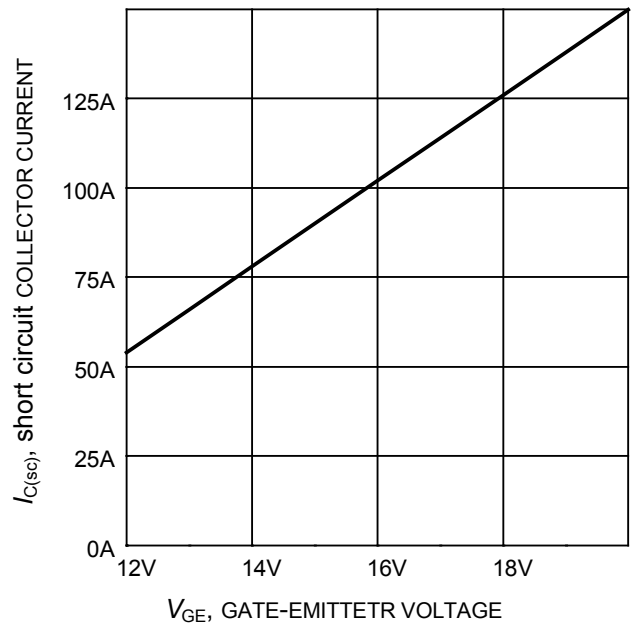

Figure 20. Typical short circuit collector current as a function of gate-emitter voltage
($V_{CE} \leq 600\text{V}$, $T_j \leq 150^\circ\text{C}$)

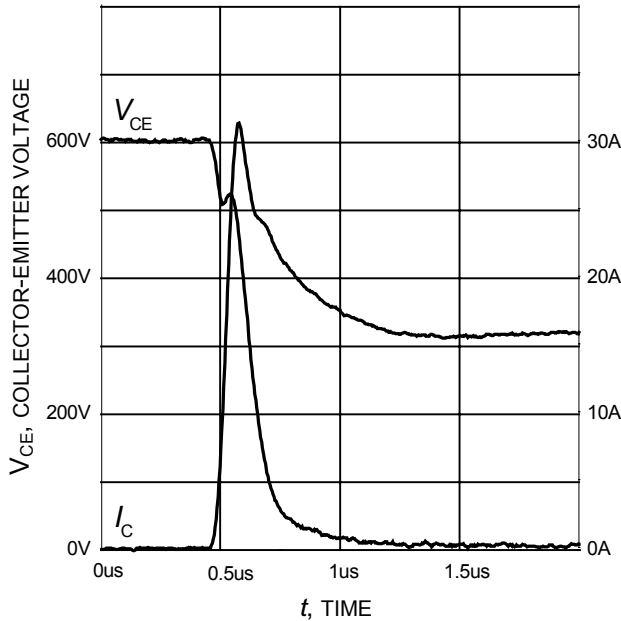

Figure 21. Typical turn on behavior
 ($V_{GE}=0/15V$, $R_G=56\Omega$, $T_j = 150^\circ C$,
 Dynamic test circuit in Figure E)

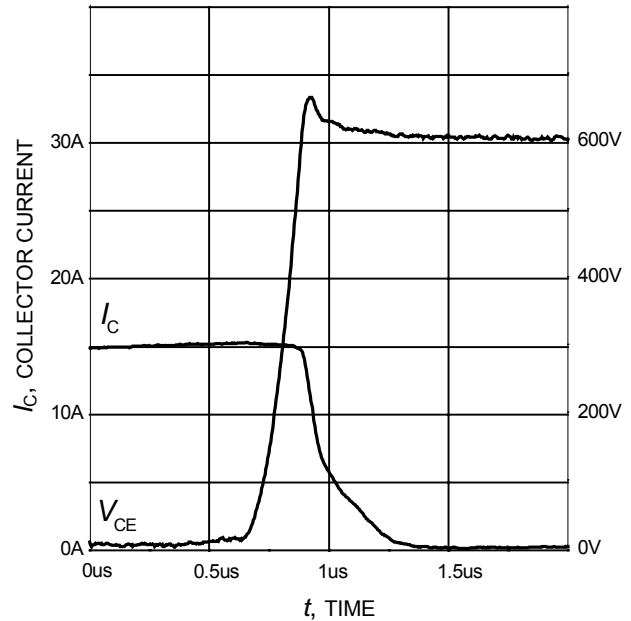

Figure 22. Typical turn off behavior
 ($V_{GE}=15/0V$, $R_G=56\Omega$, $T_j = 150^\circ C$,
 Dynamic test circuit in Figure E)

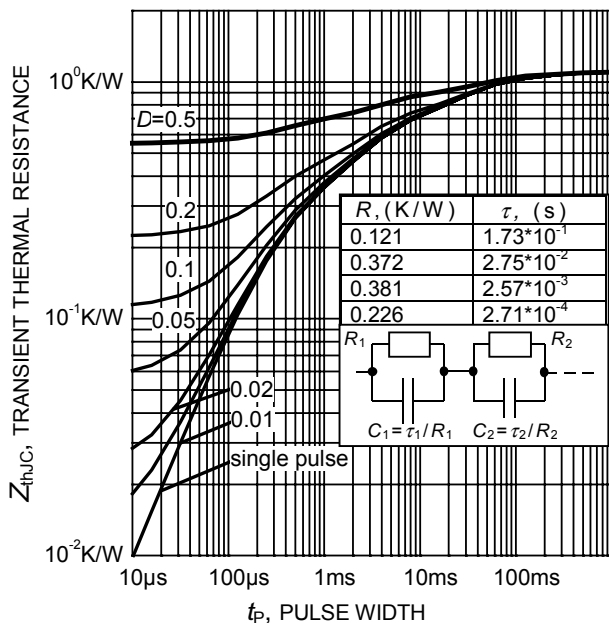

Figure 23. IGBT transient thermal resistance
 ($D = t_p / T$)

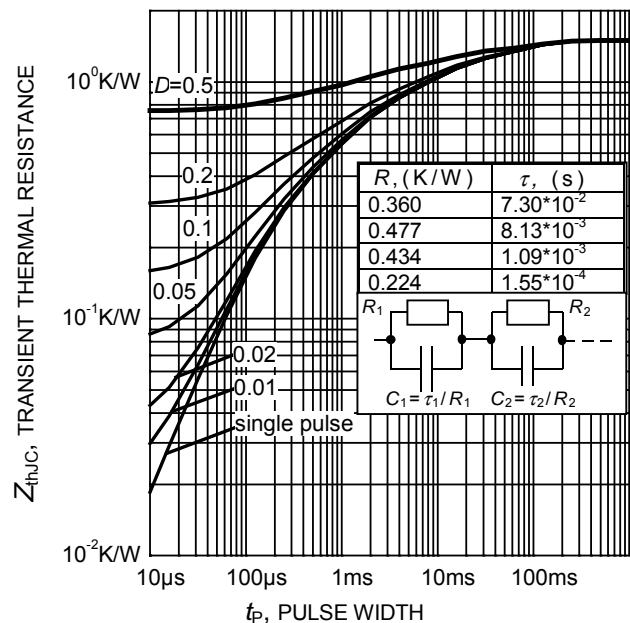

Figure 24. Diode transient thermal impedance as a function of pulse width
 ($D = t_p / T$)

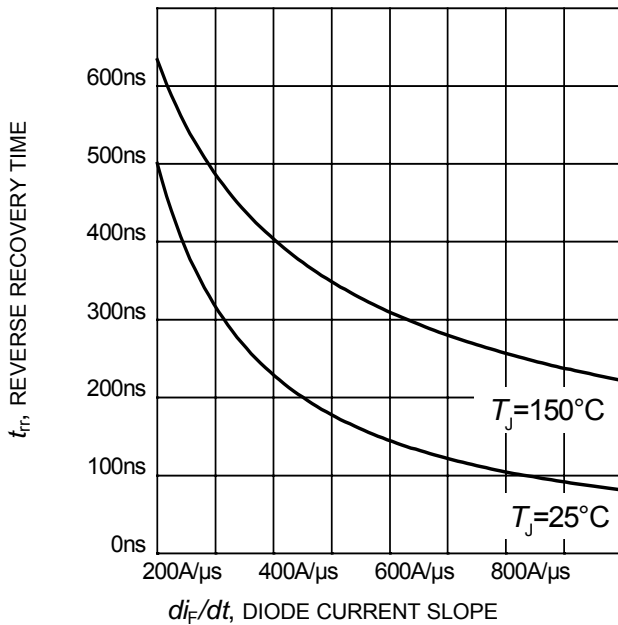

Figure 23. Typical reverse recovery time as a function of diode current slope
 ($V_R=600V$, $I_F=15A$,
 Dynamic test circuit in Figure E)

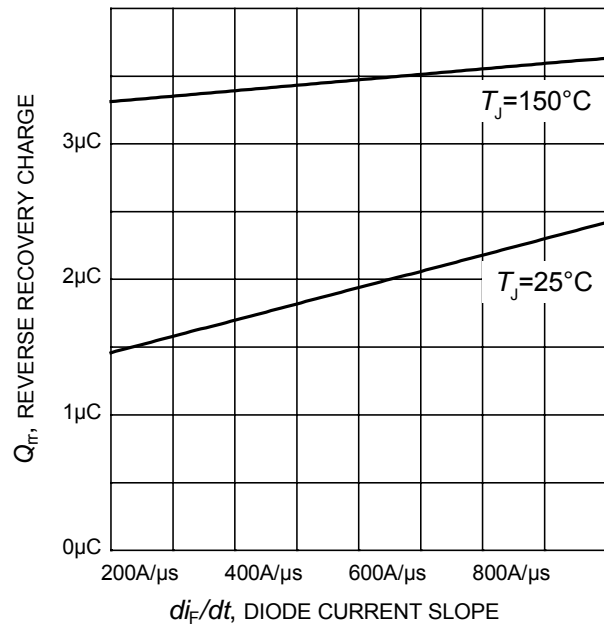

Figure 24. Typical reverse recovery charge as a function of diode current slope
 ($V_R=600V$, $I_F=15A$,
 Dynamic test circuit in Figure E)

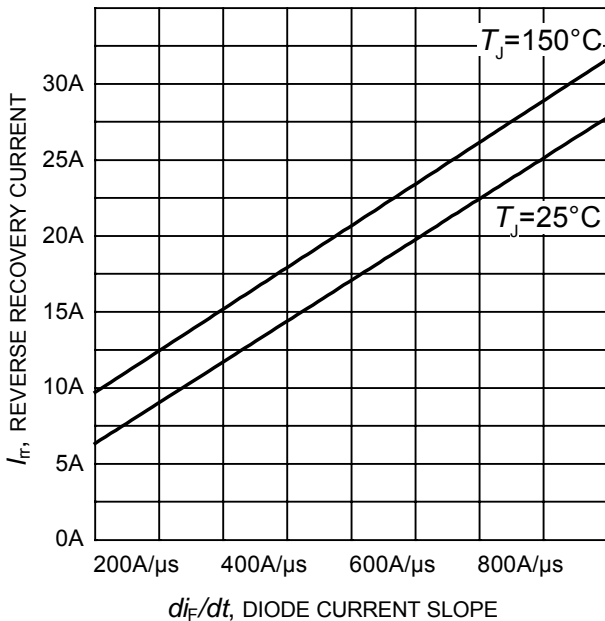

Figure 25. Typical reverse recovery current as a function of diode current slope
 ($V_R=600V$, $I_F=15A$,
 Dynamic test circuit in Figure E)

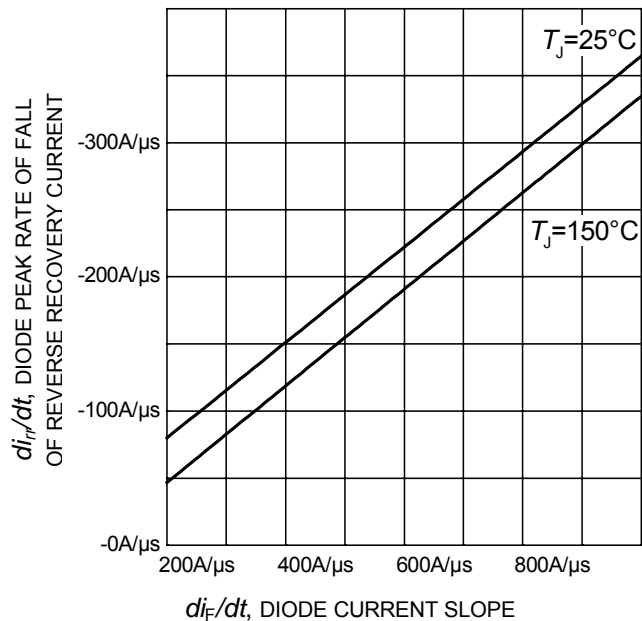

Figure 26. Typical diode peak rate of fall of reverse recovery current as a function of diode current slope
 ($V_R=600V$, $I_F=15A$,
 Dynamic test circuit in Figure E)

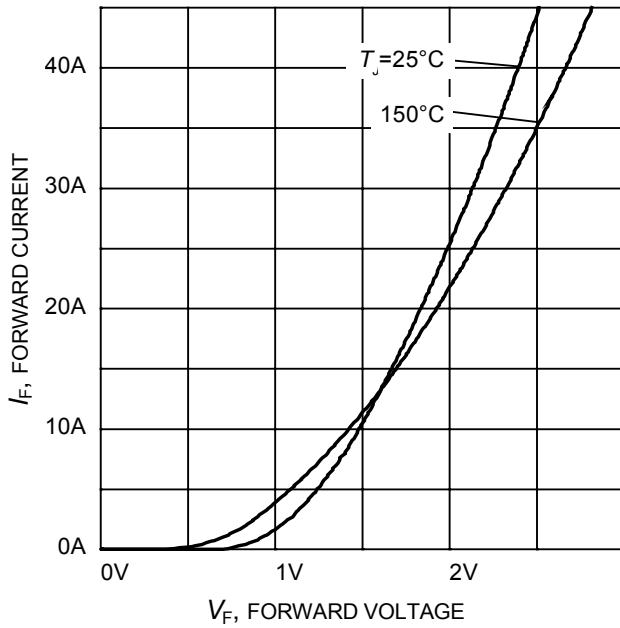

Figure 27. Typical diode forward current as a function of forward voltage

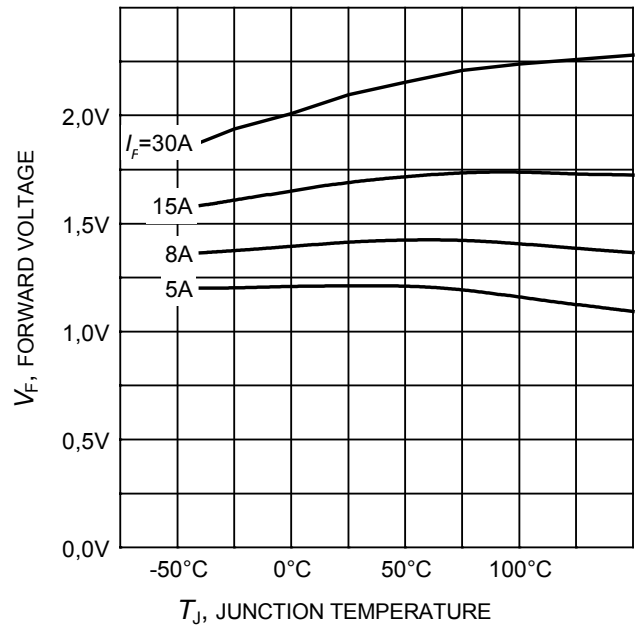
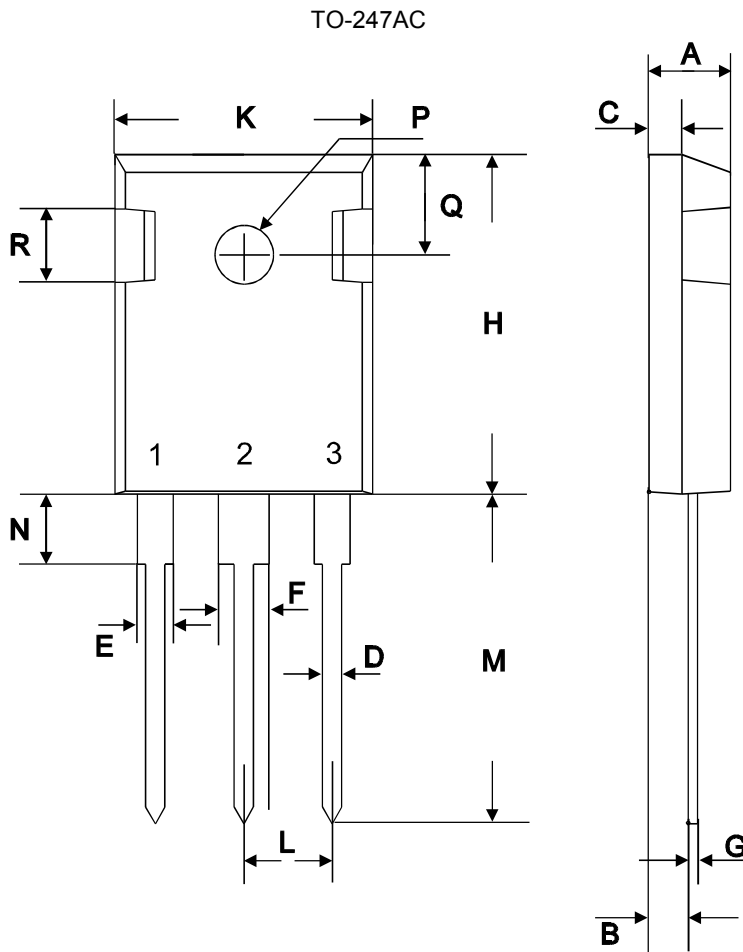

Figure 28. Typical diode forward voltage as a function of junction temperature



symbol	dimensions			
	[mm]		[inch]	
	min	max	min	max
A	4.78	5.28	0.1882	0.2079
B	2.29	2.51	0.0902	0.0988
C	1.78	2.29	0.0701	0.0902
D	1.09	1.32	0.0429	0.0520
E	1.73	2.06	0.0681	0.0811
F	2.67	3.18	0.1051	0.1252
G	0.76 max		0.0299 max	
H	20.80	21.16	0.8189	0.8331
K	15.65	16.15	0.6161	0.6358
L	5.21	5.72	0.2051	0.2252
M	19.81	20.68	0.7799	0.8142
N	3.560	4.930	0.1402	0.1941
∅P	3.61		0.1421	
Q	6.12	6.22	0.2409	0.2449

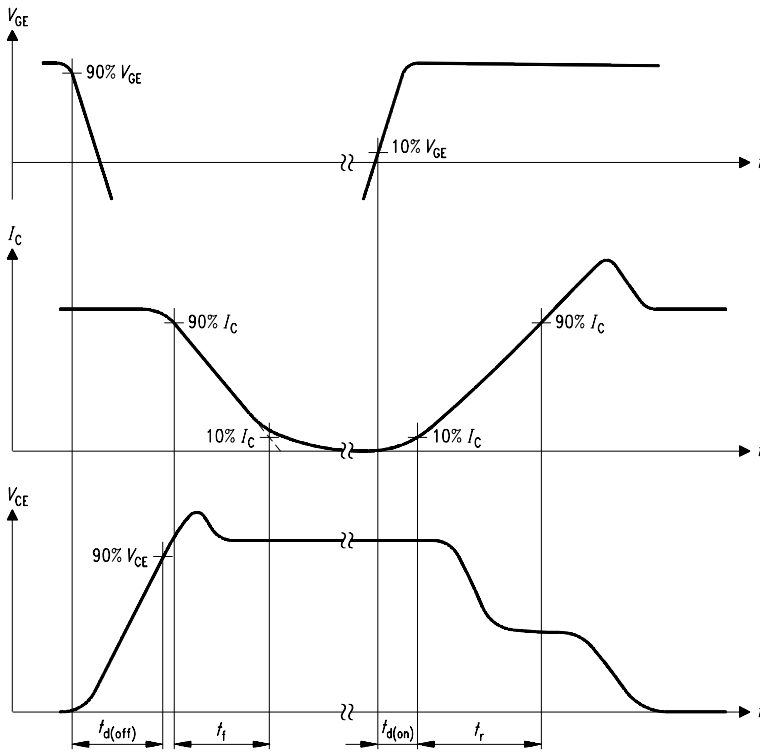

Figure A. Definition of switching times

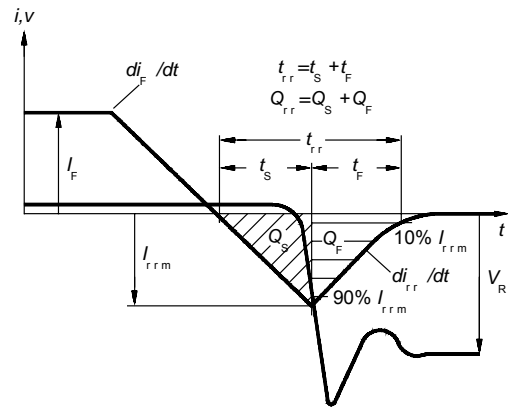

Figure C. Definition of diodes switching characteristics

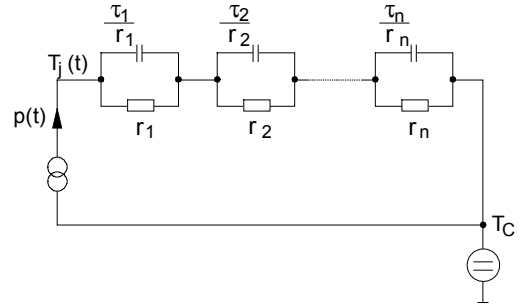

Figure D. Thermal equivalent circuit

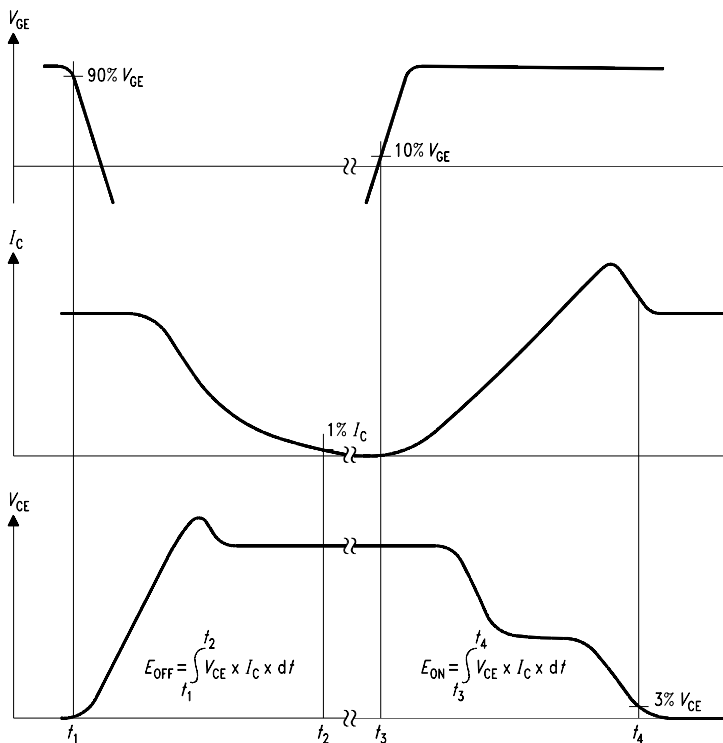

Figure B. Definition of switching losses

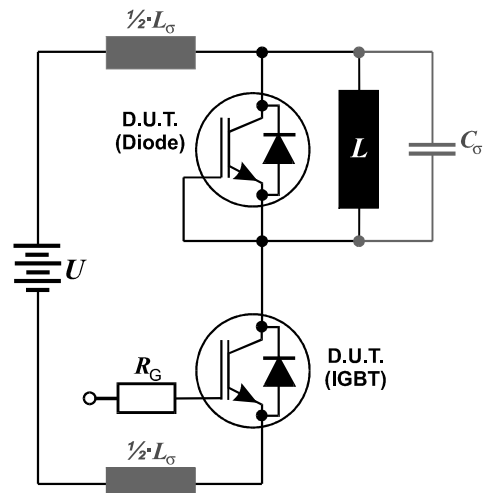

Figure E. Dynamic test circuit
Leakage inductance $L_{\sigma} = 180\text{nH}$
and Stray capacity $C_{\sigma} = 39\text{pF}$.

Published by
Infineon Technologies AG,
Bereich Kommunikation
St.-Martin-Strasse 53,
D-81541 München
© Infineon Technologies AG 2001
All Rights Reserved.

Attention please!

The information herein is given to describe certain components and shall not be considered as warranted characteristics.

Terms of delivery and rights to technical change reserved.

We hereby disclaim any and all warranties, including but not limited to warranties of non-infringement, regarding circuits, descriptions and charts stated herein.

Infineon Technologies is an approved CECC manufacturer.

Information

For further information on technology, delivery terms and conditions and prices please contact your nearest Infineon Technologies Office in Germany or our Infineon Technologies Representatives worldwide (see address list).

Warnings

Due to technical requirements components may contain dangerous substances. For information on the types in question please contact your nearest Infineon Technologies Office.

Infineon Technologies Components may only be used in life-support devices or systems with the express written approval of Infineon Technologies, if a failure of such components can reasonably be expected to cause the failure of that life-support device or system, or to affect the safety or effectiveness of that device or system. Life support devices or systems are intended to be implanted in the human body, or to support and/or maintain and sustain and/or protect human life. If they fail, it is reasonable to assume that the health of the user or other persons may be endangered.