

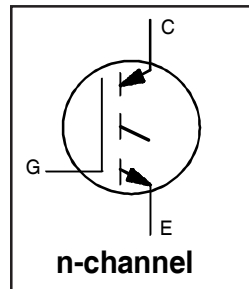
# IRG4BC20UPbF

INSULATED GATE BIPOLAR TRANSISTOR

UltraFast Speed IGBT

## Features

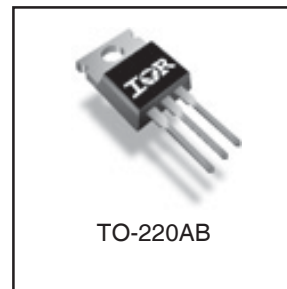
- UltraFast: optimized for high operating frequencies 8-40 kHz in hard switching, >200 kHz in resonant mode
- Generation 4 IGBT design provides tighter parameter distribution and higher efficiency than Generation 3
- Industry standard TO-220AB package
- Lead-Free



$V_{CES} = 600V$
$V_{CE(on) typ.} = 1.85V$
@ $V_{GE} = 15V, I_C = 6.5A$

## Benefits

- Generation 4 IGBTs offer highest efficiency available
- IGBTs optimized for specified application conditions
- Designed to be a "drop-in" replacement for equivalent industry-standard Generation 3 IR IGBTs



## Absolute Maximum Ratings

	Parameter	Max.	Units
$V_{CES}$	Collector-to-Emitter Breakdown Voltage	600	V
$I_C @ T_C = 25^\circ C$	Continuous Collector Current	13	A
$I_C @ T_C = 100^\circ C$	Continuous Collector Current	6.5	
$I_{CM}$	Pulsed Collector Current ①	52	
$I_{LM}$	Clamped Inductive Load Current ②	52	
$V_{GE}$	Gate-to-Emitter Voltage	$\pm 20$	V
$E_{ARV}$	Reverse Voltage Avalanche Energy ③	5.0	mJ
$P_D @ T_C = 25^\circ C$	Maximum Power Dissipation	60	W
$P_D @ T_C = 100^\circ C$	Maximum Power Dissipation	24	
$T_J$	Operating Junction and Storage Temperature Range	-55 to + 150	°C
$T_{STG}$			
	Mounting torque, 6-32 or M3 screw.	10 lbf·in (1.1N·m)	

## Thermal Resistance

	Parameter	Typ.	Max.	Units
$R_{\theta JC}$	Junction-to-Case	---	2.1	°C/W
$R_{\theta CS}$	Case-to-Sink, Flat, Greased Surface	0.50	---	
$R_{\theta JA}$	Junction-to-Ambient, typical socket mount	---	80	
Wt	Weight	2.0 (0.07)	---	g (oz)

## Electrical Characteristics @ T<sub>J</sub> = 25°C (unless otherwise specified)

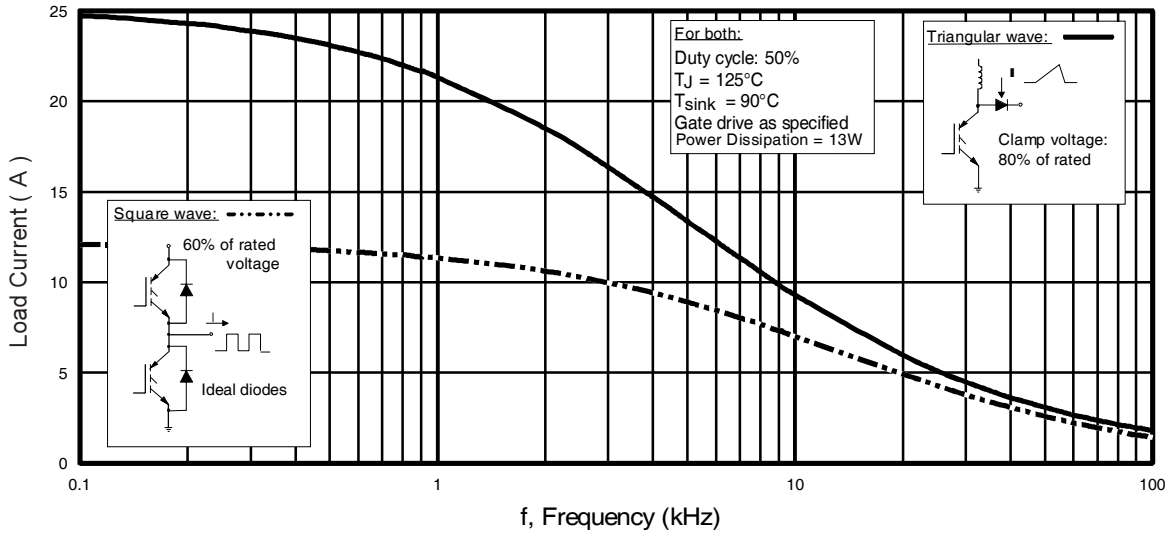
	Parameter	Min.	Typ.	Max.	Units	Conditions
V <sub>(BR)CES</sub>	Collector-to-Emitter Breakdown Voltage	600	—	—	V	V <sub>GE</sub> = 0V, I <sub>C</sub> = 250μA
V <sub>(BR)ECS</sub>	Emitter-to-Collector Breakdown Voltage ④	18	—	—	V	V <sub>GE</sub> = 0V, I <sub>C</sub> = 1.0A
ΔV <sub>(BR)CES/ΔT<sub>J</sub></sub>	Temperature Coeff. of Breakdown Voltage	—	0.69	—	V/°C	V <sub>GE</sub> = 0V, I <sub>C</sub> = 1.0mA
V <sub>CE(ON)</sub>	Collector-to-Emitter Saturation Voltage	—	1.85	2.1	V	I <sub>C</sub> = 6.5A I <sub>C</sub> = 13A I <sub>C</sub> = 6.5A, T <sub>J</sub> = 150°C V <sub>GE</sub> = 15V See Fig.2, 5
		—	2.27	—		
		—	1.87	—		
V <sub>GE(th)</sub>	Gate Threshold Voltage	3.0	—	6.0		V <sub>CE</sub> = V <sub>GE</sub> , I <sub>C</sub> = 250μA
ΔV <sub>GE(th)/ΔT<sub>J</sub></sub>	Temperature Coeff. of Threshold Voltage	—	-11	—	mV/°C	V <sub>CE</sub> = V <sub>GE</sub> , I <sub>C</sub> = 250μA
g <sub>fe</sub>	Forward Transconductance ⑤	1.4	4.3	—	S	V <sub>CE</sub> = 100V, I <sub>C</sub> = 6.5A
I <sub>CES</sub>	Zero Gate Voltage Collector Current	—	—	250	μA	V <sub>GE</sub> = 0V, V <sub>CE</sub> = 600V
		—	—	2.0		V <sub>GE</sub> = 0V, V <sub>CE</sub> = 10V, T <sub>J</sub> = 25°C
		—	—	1000		V <sub>GE</sub> = 0V, V <sub>CE</sub> = 600V, T <sub>J</sub> = 150°C
I <sub>GES</sub>	Gate-to-Emitter Leakage Current	—	—	±100	nA	V <sub>GE</sub> = ±20V

## Switching Characteristics @ T<sub>J</sub> = 25°C (unless otherwise specified)

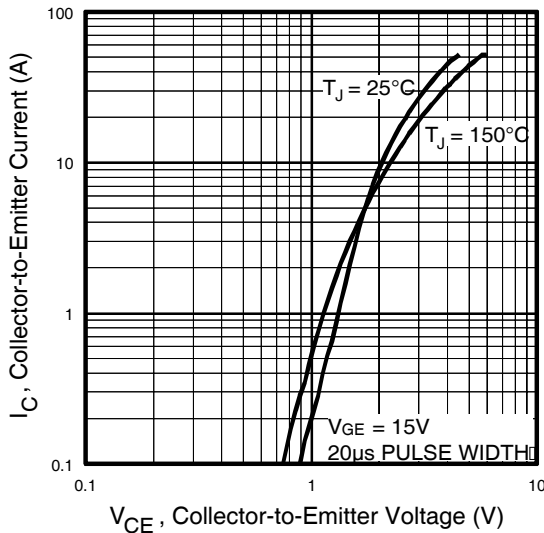
	Parameter	Min.	Typ.	Max.	Units	Conditions
Q <sub>g</sub>	Total Gate Charge (turn-on)	—	27	41	nC	I <sub>C</sub> = 6.5A V <sub>CC</sub> = 400V V <sub>GE</sub> = 15V See Fig. 8
Q <sub>ge</sub>	Gate - Emitter Charge (turn-on)	—	4.5	6.8		
Q <sub>gc</sub>	Gate - Collector Charge (turn-on)	—	10	16		
t <sub>d(on)</sub>	Turn-On Delay Time	—	21	—	ns	T <sub>J</sub> = 25°C I <sub>C</sub> = 6.5A, V <sub>CC</sub> = 480V V <sub>GE</sub> = 15V, R <sub>G</sub> = 50Ω Energy losses include "tail" See Fig. 10, 11, 13, 14
t <sub>r</sub>	Rise Time	—	13	—		
t <sub>d(off)</sub>	Turn-Off Delay Time	—	86	130		
t <sub>f</sub>	Fall Time	—	120	180		
E <sub>on</sub>	Turn-On Switching Loss	—	0.10	—	mJ	See Fig. 10, 11, 13, 14
E <sub>off</sub>	Turn-Off Switching Loss	—	0.12	—		
E <sub>ts</sub>	Total Switching Loss	—	0.22	0.4		
t <sub>d(on)</sub>	Turn-On Delay Time	—	20	—	ns	T <sub>J</sub> = 150°C, I <sub>C</sub> = 6.5A, V <sub>CC</sub> = 480V V <sub>GE</sub> = 15V, R <sub>G</sub> = 50Ω Energy losses include "tail" See Fig. 13, 14
t <sub>r</sub>	Rise Time	—	14	—		
t <sub>d(off)</sub>	Turn-Off Delay Time	—	190	—		
t <sub>f</sub>	Fall Time	—	140	—		
E <sub>ts</sub>	Total Switching Loss	—	0.42	—	mJ	
L <sub>E</sub>	Internal Emitter Inductance	—	7.5	—	nH	Measured 5mm from package
C <sub>ies</sub>	Input Capacitance	—	530	—	pF	V <sub>GE</sub> = 0V V <sub>CC</sub> = 30V f = 1.0MHz See Fig. 7
C <sub>oes</sub>	Output Capacitance	—	39	—		
C <sub>res</sub>	Reverse Transfer Capacitance	—	7.4	—		

### Notes:

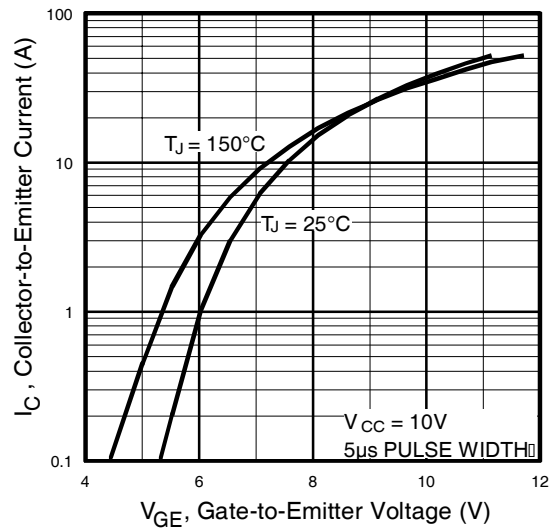
- ① Repetitive rating; V<sub>GE</sub> = 20V, pulse width limited by max. junction temperature. ( See fig. 13b )
- ② V<sub>CC</sub> = 80%(V<sub>CES</sub>), V<sub>GE</sub> = 20V, L = 10μH, R<sub>G</sub> = 50Ω, (See fig. 13a)
- ③ Repetitive rating; pulse width limited by maximum junction temperature.
- ④ Pulse width ≤ 80μs; duty factor ≤ 0.1%.
- ⑤ Pulse width 5.0μs, single shot.



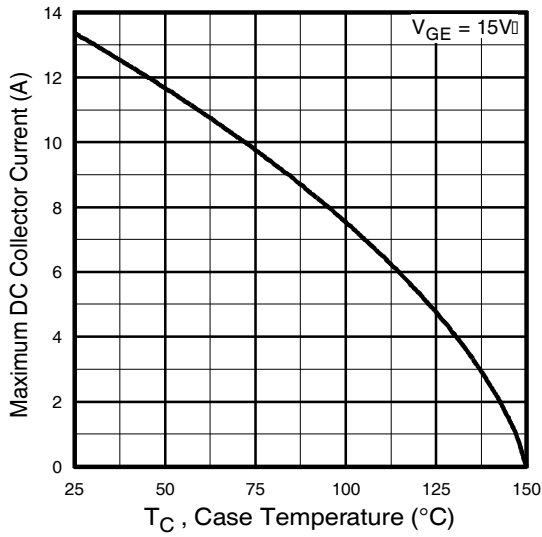
**Fig. 1 - Typical Load Current vs. Frequency**  
(For square wave,  $I = I_{\text{RMS}}$  of fundamental; for triangular wave,  $I = I_{\text{PK}}$ )



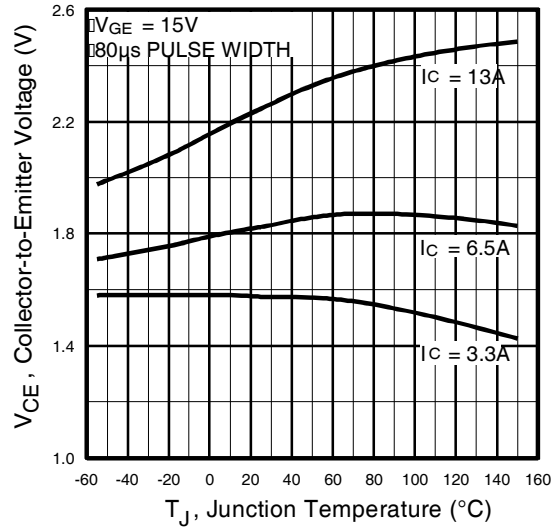
**Fig. 2 - Typical Output Characteristics**



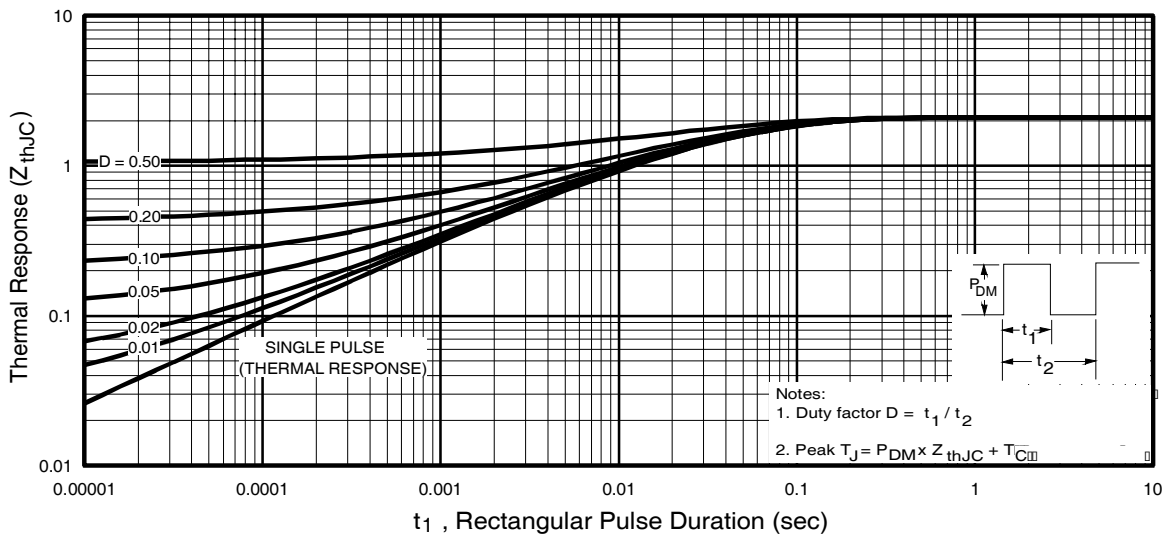
**Fig. 3 - Typical Transfer Characteristics**



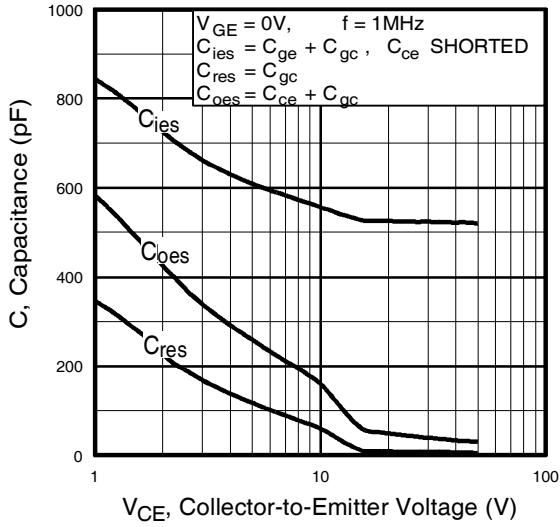
**Fig. 4 - Maximum Collector Current vs. Case Temperature**



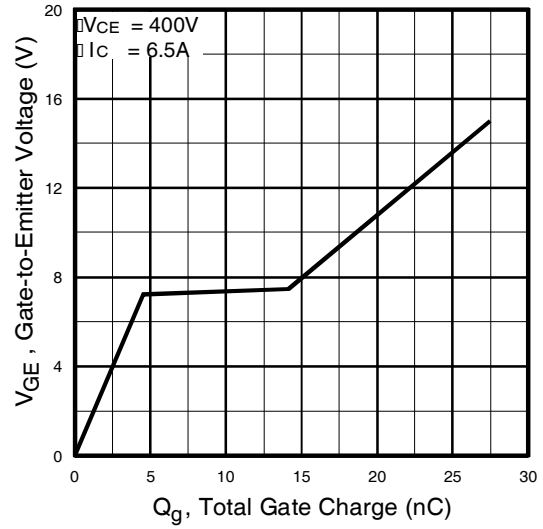
**Fig. 5 - Collector-to-Emitter Voltage vs. Junction Temperature**



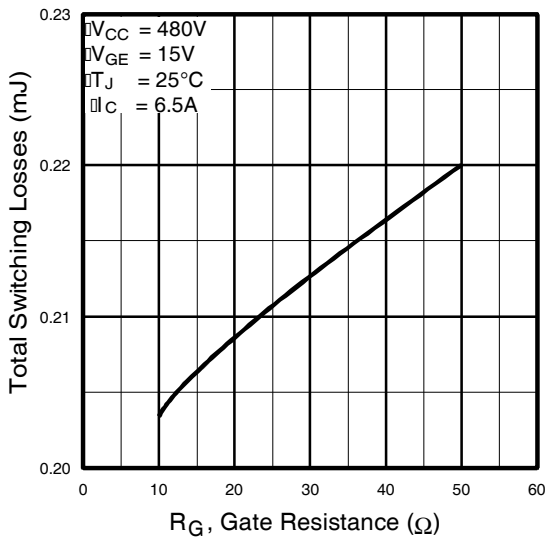
**Fig. 6 - Maximum Effective Transient Thermal Impedance, Junction-to-Case**



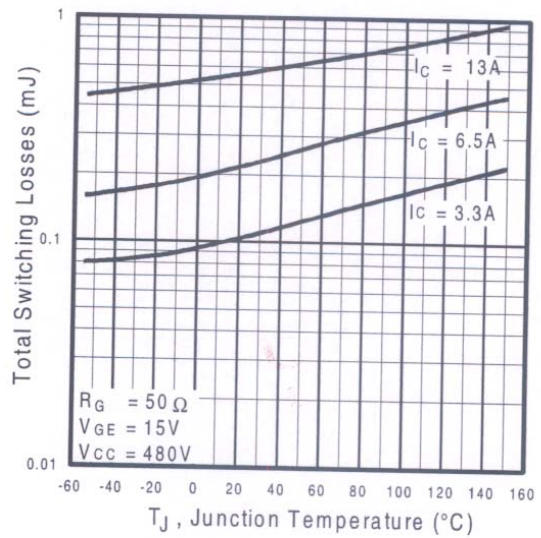
**Fig. 7** - Typical Capacitance vs. Collector-to-Emitter Voltage



**Fig. 8** - Typical Gate Charge vs. Gate-to-Emitter Voltage

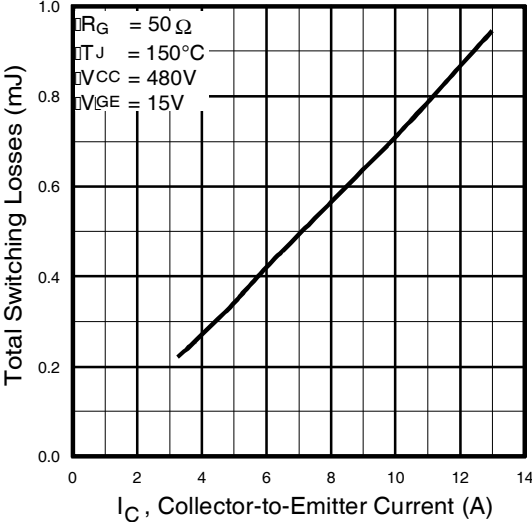


**Fig. 9** - Typical Switching Losses vs. Gate Resistance

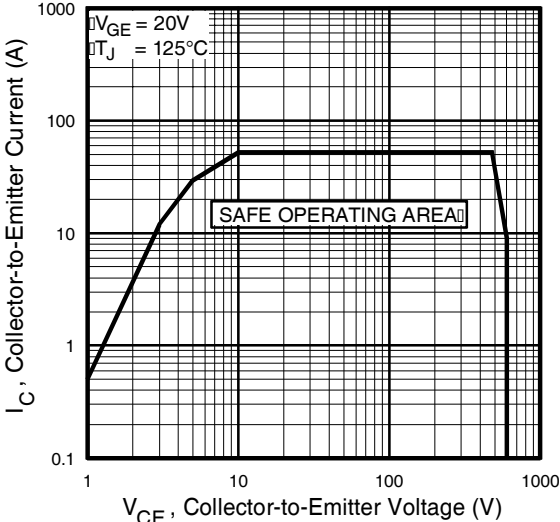


**Fig. 10** - Typical Switching Losses vs. Junction Temperature

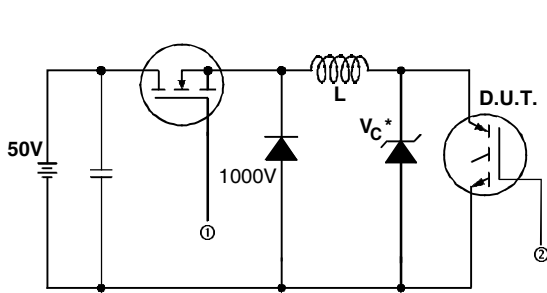
# IRG4BC20UPbF



**Fig. 11** - Typical Switching Losses vs. Collector-to-Emitter Current

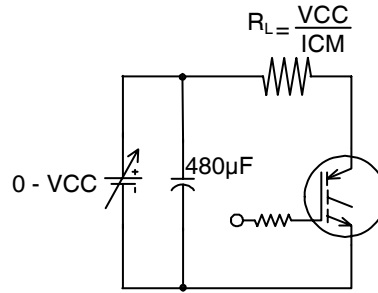


**Fig. 12** - Turn-Off SOA

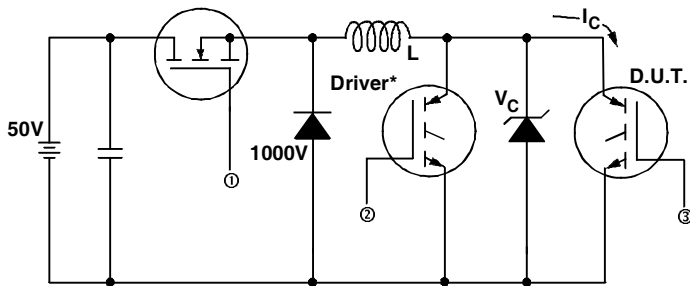


\* Driver same type as D.U.T.;  $V_c = 80\%$  of  $V_{ce(max)}$   
 \* Note: Due to the 50V power supply, pulse width and inductor will increase to obtain rated  $I_d$ .

**Fig. 13a** - Clamped Inductive Load Test Circuit

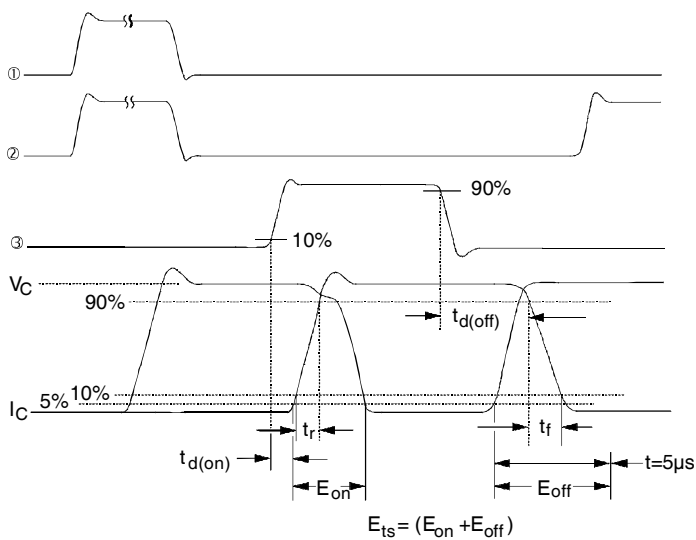


**Fig. 13b** - Pulsed Collector Current Test Circuit



**Fig. 14a** - Switching Loss Test Circuit

\* Driver same type as D.U.T.,  $V_C = 480V$

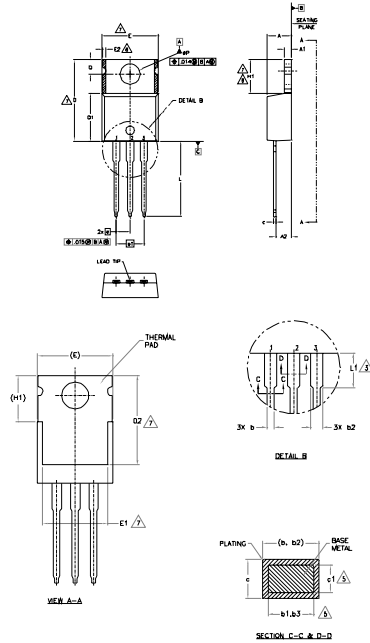


**Fig. 14b** - Switching Loss Waveforms

# IRG4BC20UPbF

International  
**IR** Rectifier

## TO-220AB Package Outline (Dimensions are shown in millimeters (inches))



- NOTES:
- 1.- DIMENSIONING AND TOLERANCING AS PER ASME Y14.5 M- 1994.
  - 2.- DIMENSIONS ARE SHOWN IN MILLIMETERS (INCHES).
  - 3.- LEAD DIMENSION AND FINISH UNCONTROLLED IN 1:1.
  - 4.- DIMENSION D1, D1' & E DO NOT INCLUDE WELD FLASH. WELD FLASH SHALL NOT EXCEED .005" (0.127) PER SIDE. THESE DIMENSIONS ARE MEASURED AT THE OUTERMOST EXTREMES OF THE PLASTIC BODY.
  - 5.- DIMENSION H1, H2 & c1 APPLY TO BASE METAL ONLY.
  - 6.- CONTROLLING DIMENSION - INCHES.
  - 7.- THERMAL PAD CONTOUR OPTIONAL. WITHIN DIMENSIONS E4, D2 & E1.
  - 8.- DIMENSION E2 IS THE DESIGN A ZONE WHERE STAMPING AND SINGULATION IRREGULARITIES ARE ALLOWED.
  - 9.- OUTLINE CONFORMS TO JEDEC TO-220, EXCEPT A2 (max.) AND D2 (min.) WHERE DIMENSIONS ARE DERIVED FROM THE ACTUAL PACKAGE OUTLINE.

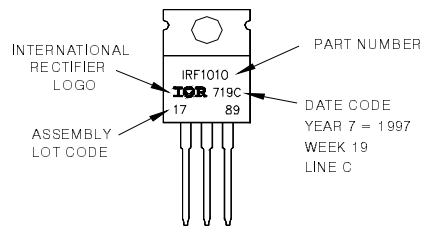
SYMBOL	DIMENSIONS				NOTES
	MILLIMETERS		INCHES		
	MIN	MAX	MIN	MAX	
A	3.56	4.83	.140	.190	
A1	0.51	1.40	.020	.055	
A2	2.03	2.92	.080	.115	
b	0.38	1.01	.015	.040	5
b1	0.38	0.97	.015	.038	
b2	1.14	1.78	.045	.070	
b3	1.14	1.73	.045	.068	5
c	0.35	0.61	.014	.024	
c1	0.35	0.56	.014	.022	5
D	14.22	16.61	.560	.650	4
D1	8.38	9.02	.330	.355	
D2	11.68	12.88	.460	.507	7
E	9.65	10.67	.380	.420	4,7
E1	6.86	8.89	.270	.350	7
E2	-	0.76	-	.030	8
e	2.54 BSC		.100 BSC		
e1	2.54 BSC		.100 BSC		
H1	5.84	6.86	.230	.270	7,8
L	12.70	14.73	.500	.580	
L1	3.56	4.06	.140	.160	3
MP	2.54	4.08	.100	.161	
Q	2.54	3.42	.100	.135	

- LEAD ASSIGNMENTS
- HESET
- 1- GATE
  - 2- DRN
  - 3- SOURCE
- WELD FLASK
- 1- GATE
  - 2- COLLECTOR
  - 3- EMITTER
- NOTES
- 1- ANGLE
  - 2- GATE
  - 3- ANGLE

## TO-220AB Part Marking Information

EXAMPLE: THIS IS AN IRF1010  
 LOT CODE 1789  
 ASSEMBLED ON WW 19, 1997  
 IN THE ASSEMBLY LINE 'C'

**Note:** "P" in assembly line position indicates "Lead-Free"



**Note:** For the most current drawing please refer to IR website at <http://www.irf.com/package/>

Data and specifications subject to change without notice.

International  
**IR** Rectifier

IR WORLD HEADQUARTERS: 233 Kansas St., El Segundo, California 90245, USA Tel: (310) 252-7105

TAC Fax: (310) 252-7903

Visit us at [www.irf.com](http://www.irf.com) for sales contact information.01/2010