

Typical Applications

The HMC256 is ideal for:

- Microwave Radio & VSAT
- Test Instrumentation
- Military Radios Radar & ECM
- Space

Functional Diagram

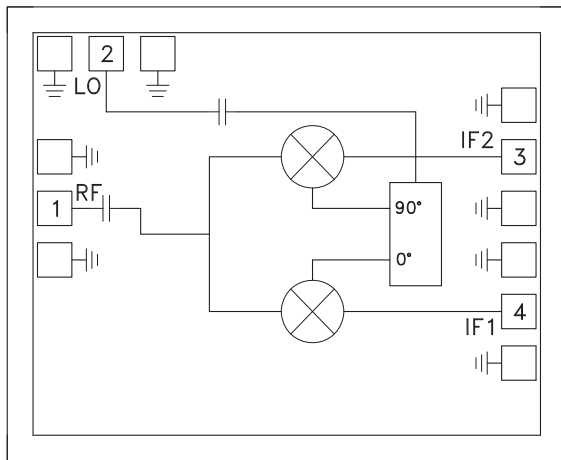

Features

- High Image Rejection: >30 dB
- Input IP3: +18 dBm
- Wideband IF: DC to 1.5 GHz
- Die Size: 1.6 x 1.3 x 0.1 mm

General Description

The HMC256 chip is a compact, 2.08 mm², I/Q Mixer MMIC which can be used as an Image Reject Mixer (IRM) or Single Sideband (SSB) upconverter. The chip utilizes two standard Hittite double-balanced mixer cells and a Lange Coupler realized in GaAs MESFET technology. All data is with the chip in a 50 Ohm test fixture connected via 0.025 mm (1 mil) diameter wire bonds of minimal length <0.51 mm (<20 mils). A low frequency quadrature hybrid was used to interface the MMIC IF ports to a 120 MHz IF USB output. This provides an example of the I/Q Mixer in an IRM application. The IF may be used from DC to 1.5 GHz. This I/Q Mixer is a more reliable, much smaller replacement to hybrid drop-in style I/Q Mixer assemblies.

Electrical Specifications, $T_A = +25^\circ \text{C}$, As an IRM

Parameter	IF = 70 - 200 MHz LO = +18 dBm			IF = 70 - 200 MHz LO = +15 dBm			Units
	Min.	Typ.	Max.	Min.	Typ.	Max.	
Frequency Range, RF	5.9 - 12			7.1 - 11.7			GHz
Frequency Range, LO	5.7 - 12			6.9 - 11.7			GHz
Frequency Range, IF	DC - 1.5			DC - 1.5			GHz
Conversion Loss		8	10.5		8	10.5	dB
Noise Figure (SSB)		8	10.5		8	10.5	dB
Image Rejection (IR)	24	32		20	30		dB
LO to RF Isolation	22	30		22	30		dB
LO to IF Isolation	27	35		27	35		dB
RF to IF Isolation	24	30		24	30		dB
IP3 (Input)		18			17		dBm
1 dB Gain Compression (Input)		5			5		dBm

Conversion Gain to Desired Sideband vs. Temperature @ LO = +15 dBm, IF = 120 MHz USB

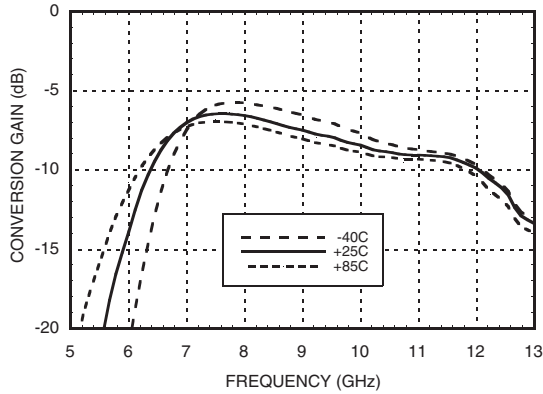

Conversion Gain to Desired Sideband vs. LO Drive, IF = 120 MHz USB

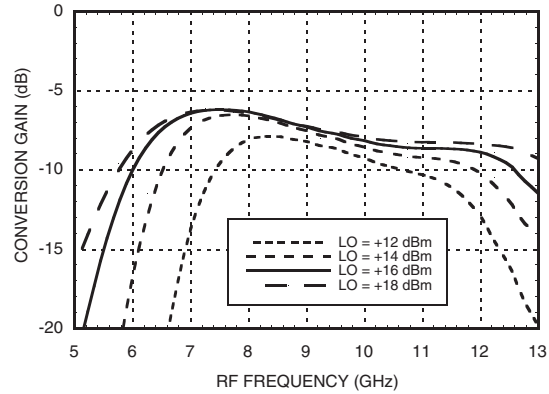

Image Rejection vs. Temperature LO = +15 dBm, IF = 120MHz USB

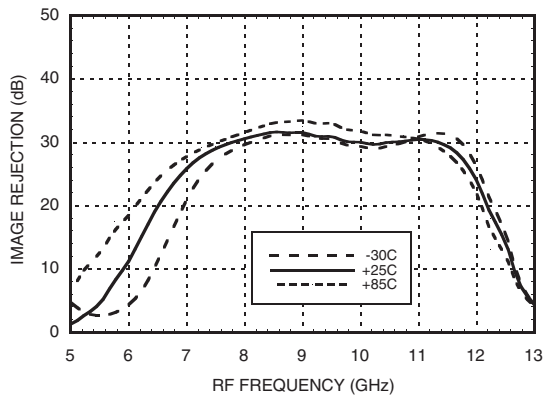
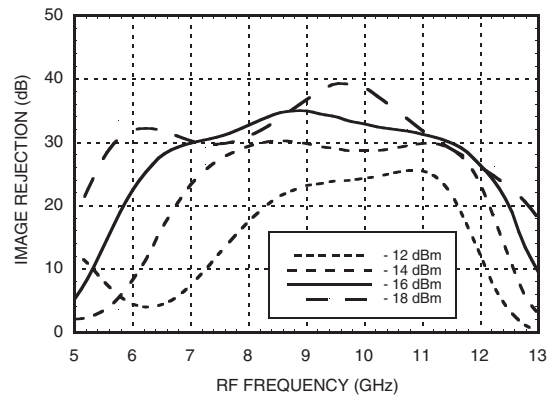
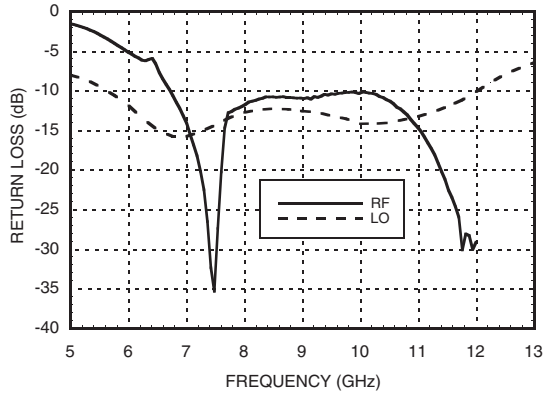

Image Rejection vs. LO Drive, IF = 120 MHz USB



Return Loss @ LO = +15 dBm



Isolations @ LO = +15 dBm

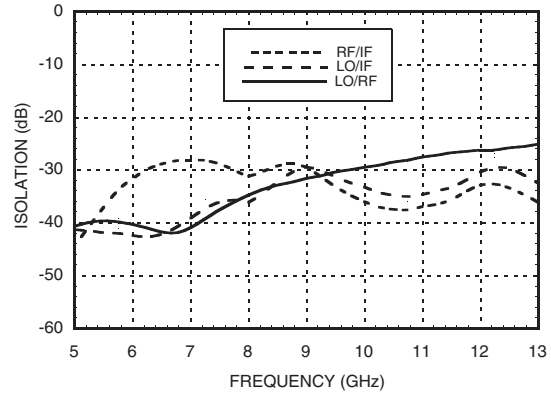

IF Bandwidth @ LO = 15 dBm

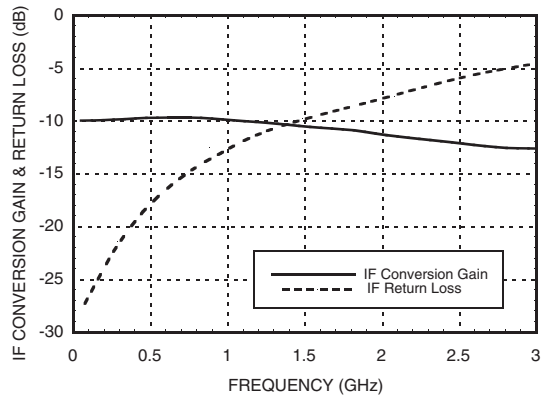

Input IP3 vs. LO Drive, IF = 120 MHz USB

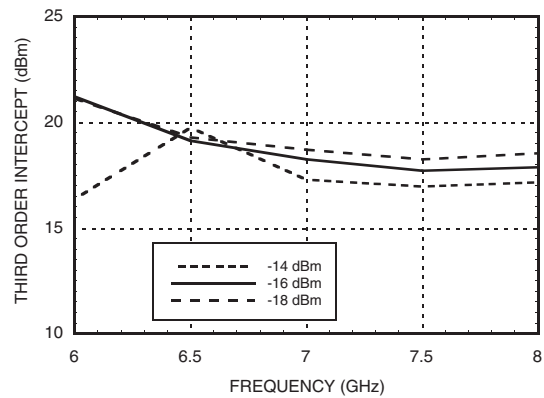

Absolute Maximum Ratings

RF / IF Input	+13 dBm
LO Drive	+27 dBm
Channel Temperature	150 °C
Continuous P _{diss} (T = 85 °C) (derate 9.36 mW/°C above 85 °C)	0.61 W
Thermal Resistance (R _{TH}) (junction to die bottom)	106.8 °C/W
Storage Temperature	-65 to +150 °C
Operating Temperature	-55 to +85 °C



ELECTROSTATIC SENSITIVE DEVICE
OBSERVE HANDLING PRECAUTIONS

Outline Drawing

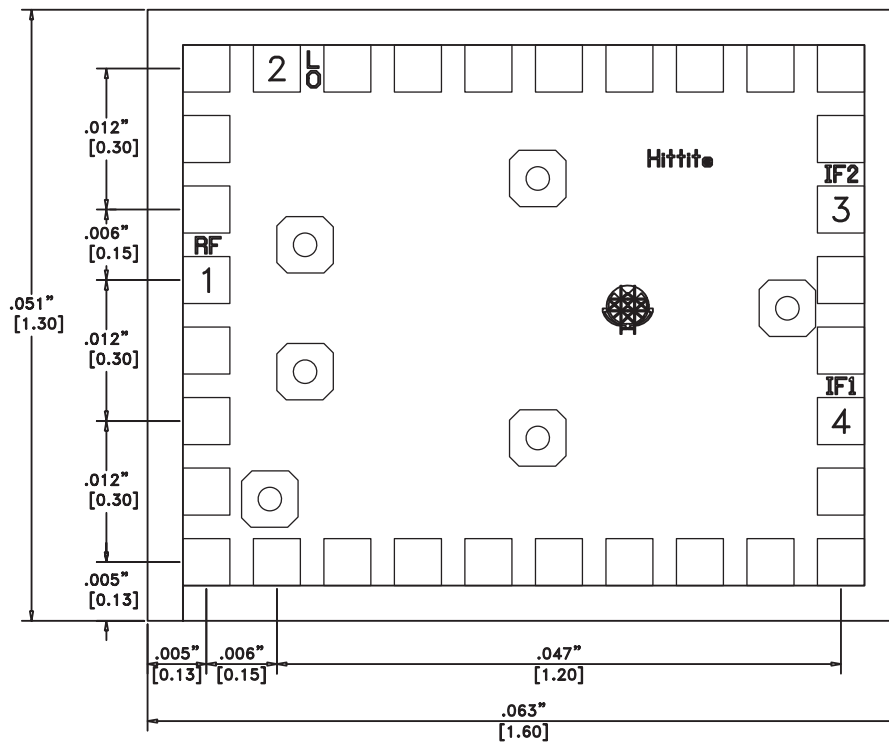

Die Packaging Information [1]

Standard	Alternate
WP-3	[2]

[1] Refer to the "Packaging Information" section for die packaging dimensions.

[2] For alternate packaging information contact Hittite Microwave Corporation.

NOTES:

1. ALL DIMENSIONS ARE IN INCHES [MM].
2. BOND PADS ARE .004" SQUARE.
3. TYPICAL BOND PAD SPACING CENTER TO CENTER IS .006".
4. BACKSIDE METALLIZATION: GOLD.
5. BOND PAD METALLIZATION: GOLD.
6. BACKSIDE METAL IS GROUND.
7. CONNECTION NOT REQUIRED FOR UNLABELED BOND PADS.

*For price, delivery, and to place orders, please contact Hittite Microwave Corporation:
20 Alpha Road, Chelmsford, MA 01824 Phone: 978-250-3343 Fax: 978-250-3373
Order On-line at www.hittite.com*

Pad Descriptions

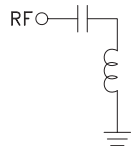
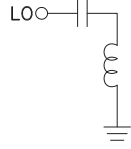
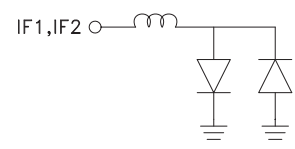
Pad Number	Function	Description	Interface Schematic
1	RF	This pin is AC coupled and matched to 50 Ohm.	
2	LO	This pin is AC coupled and matched to 50 Ohm.	
3, 4	IF1, IF2	This pin is DC coupled. For operation to DC pin must not sink/source more than 2 mA of current or failure may result.	
Backside	GND	The backside of the die must connect to RF ground.	