

Description

Dual center tap Schottky rectifier designed for high frequency Switched Mode Power Supplies.

Features

- High junction temperature capability
- Good trade off between leakage current and forward voltage drop
- Low leakage current

Applications

- | | |
|--|--|
| <ul style="list-style-type: none"> ■ Switching Power Supply ■ Industrial Application ■ Computer and Peripheral ■ Home Appliance ■ Consumer Product ■ Battery Charger/Adapter | <ul style="list-style-type: none"> ■ LCD Monitor/TV ■ AC-DC Converter ■ DC-DC Converter ■ Telecommunication ■ Free Wheeling Diodes ■ Polarity Protection |
|--|--|

Marking Information and Pin Configurations (Top View)

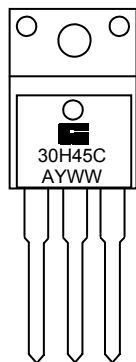

TO - 220FPAB & TO - 220AB

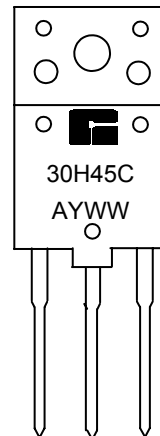

TO - 3PF

30: Maximum average forward rectified current - 30A
 H: Low V_F family
 45: Repetitive peak reverse voltage - 45V
 C: Dual Cathode Common
 A: Assembly Location
 Y: Year
 WW: Work Week

Ordering Information

ORDERING NUMBER	PACKAGE	SHIPPING
GMR30H45CTB3T	TO220AB	50 Units/ Tube
GMR30H45CTBF3T	TO220FPAB	50 Units/ Tube
GMR30H45CTPF3	TO-3PF	30 Units/ Tube

Block Diagram

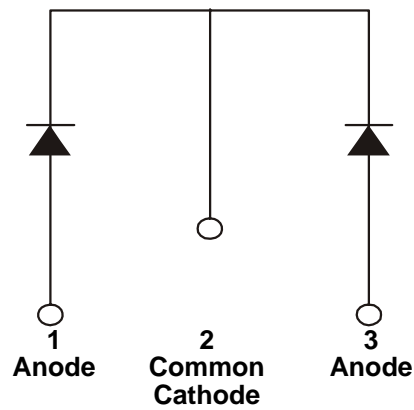

Absolute Maximum Ratings

PARAMETER	SYMBOL	VALUE	UNITS
Repetitive Peak Reverse Voltage	V_{RPM}	45	V
RMS Forward Current	$I_{F(RMS)}$	30	A
Peak Forward Surge Current 8.3ms single half sine-wave superimposed on rated load (JEDEC METHOD)	I_{FSM}	135	A
Maximum Operating Junction Temperature	T_J	175	°C
Operating storage temperature	T_{STG}	-45 to +150	°C
Voltage Rate of Change	dV/dt	10,000	V/μs
Electrostatic Discharge Voltage. JEDEC Method. ESD HBM. Contact	V_{ESD}	± 8	kV

Thermal Characteristics

PARAMETER	SYMBOL	TO220AB	TO220FPAB	TO-3PF	UNITS
Typical thermal resistance	Θ_{JC}	2.4	4.2	1.2	°C/W

Electrical Characteristics (per diode) $T_J = 25^\circ\text{C}$, Unless otherwise noted

PARAMETER	SYMBOL	Test Condition	Min	Typ	Max	Units
DC Forward Voltage	V_F	$I_F = 15\text{A}$		0.68	0.70	V
Average Rectified Forward Current	$I_{F(AV)}$				10.0	A
Maximum Reverse Current	I_R	$V_R = 45\text{V}$	-	-	10	μA
		$V_R = 45\text{V}, T_J = 125^\circ\text{C}$		-	10	mA

Package Outline Dimensions – TO220AB

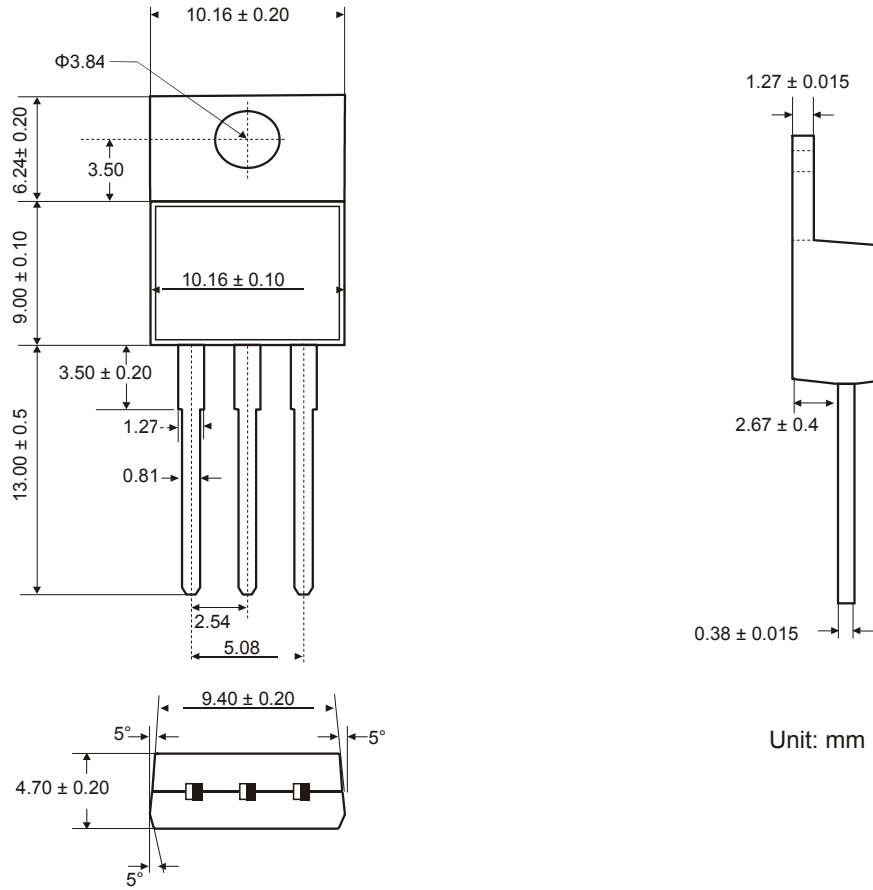

Unit: mm

Package Outline Dimensions – TO220FPAB

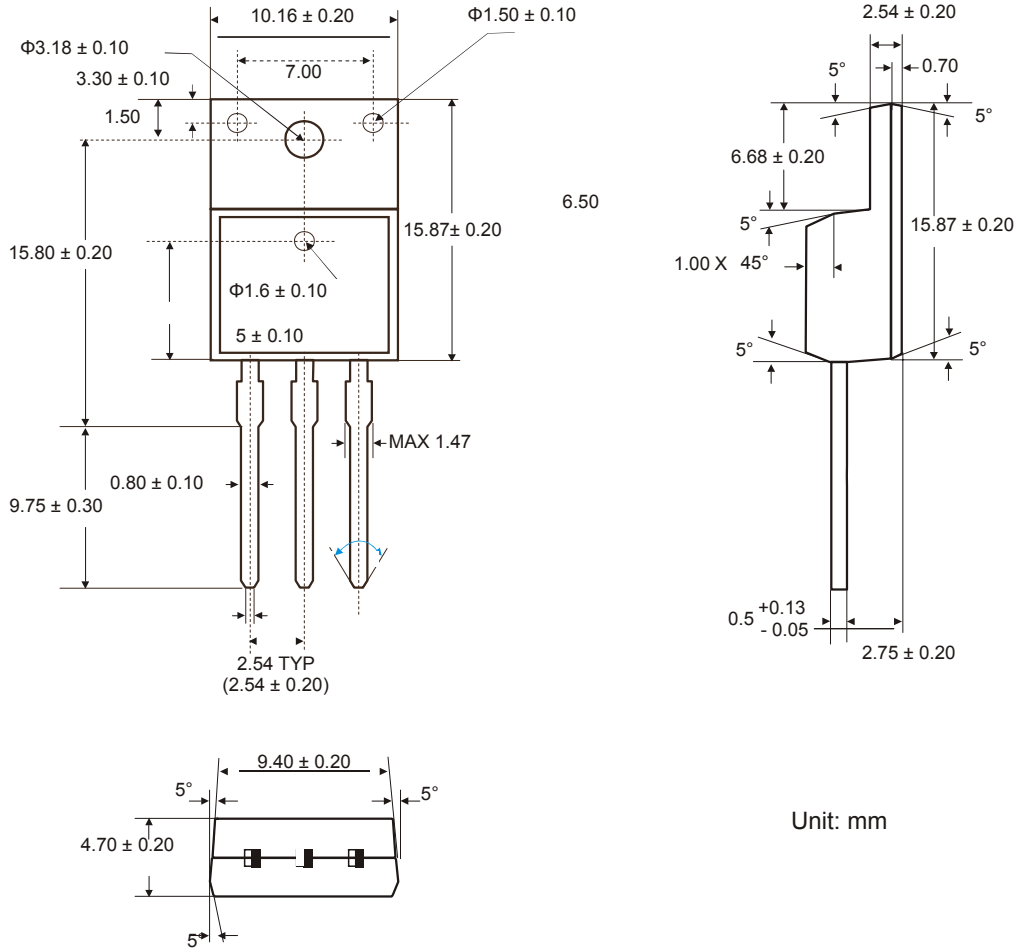

Package Outline Dimensions – TO-3PF

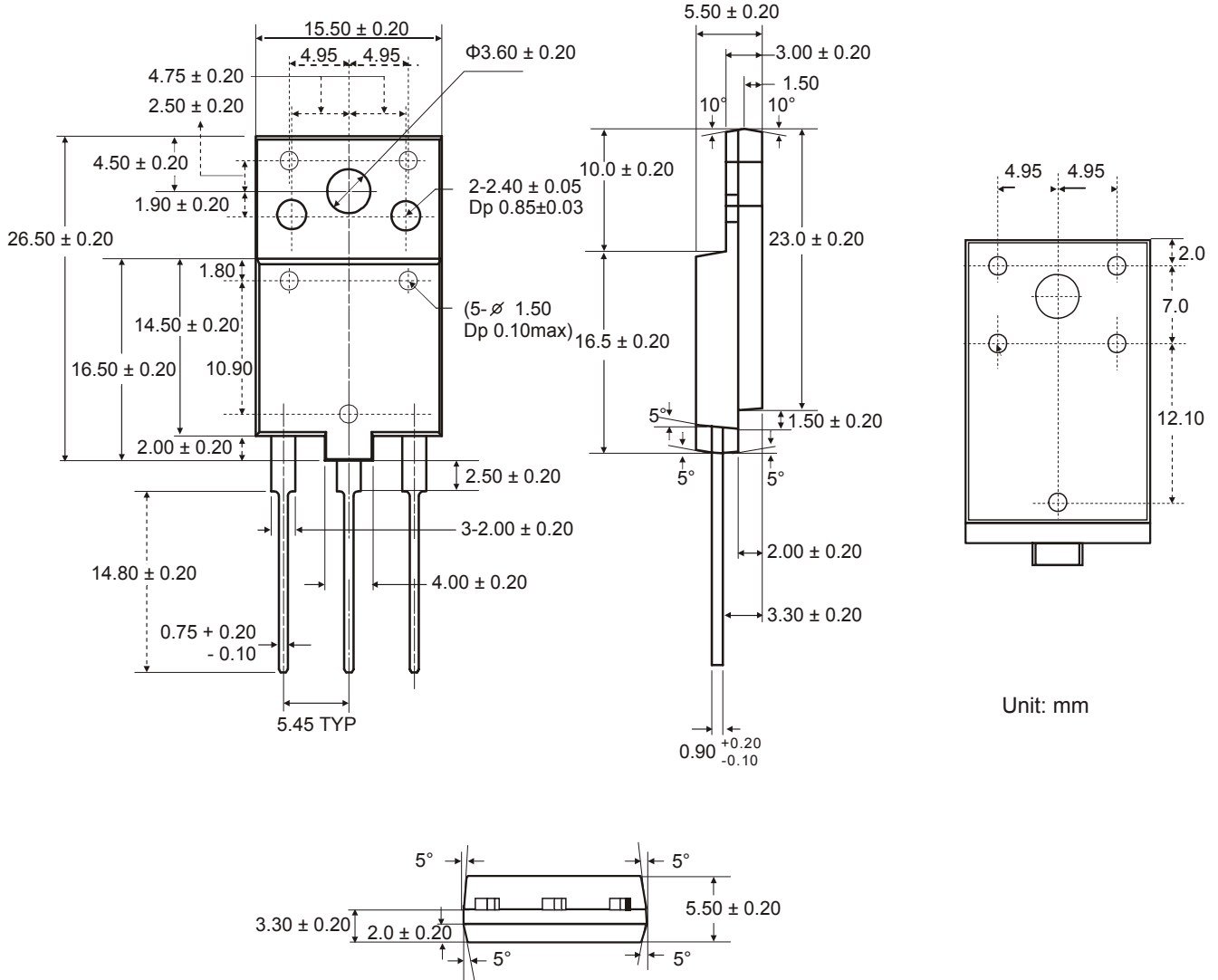

Ordering Number

<u>GM</u>	<u>R</u>	<u>20</u>	<u>H</u>	<u>100</u>	<u>C</u>	<u>TB3</u>	<u>I</u>
APM Gamma Micro	Circuit Type: Rectifier	Rated Current 10A	Low V_F Family	Rated Voltage 100V	Dual Cathode Common	Package TB3: TO220AB TBF3: TO220FPAB TPF3: TO-3PF	Shipping T: Tube R: Tape & Reel