

# 1N4001G THRU 1N4007G

## List

List.....	1
Package outline.....	2
Features.....	2
Mechanical data.....	2
Maximum ratings .....	2
Rating and characteristic curves.....	3
Pinning information.....	4
Marking.....	4
Taping & bulk specifications for AXIAL devices.....	4
Suggested thermal profiles for soldering processes.....	5
High reliability test capabilities.....	6

# 1N4001G THRU 1N4007G

## 1.0A Axial Leaded General Purpose Rectifiers - 50V-1000V

### Features

- Axial lead type devices for through hole design.
- High current capability.
- High surge capability.
- Glass passivated chip junction inside
- Lead-free parts meet environmental standards of MIL-STD-19500 /228
- Suffix "-H" indicates Halogen-free parts, ex. 1N4001G-H.

### Mechanical data

- Epoxy : UL94-V0 rated flame retardant
- Case : Molded plastic, DO-41
- Lead : Axial leads, solderable per MIL-STD-202, Method 208 guaranteed
- Polarity: Color band denotes cathode end
- Mounting Position : Any
- Weight : Approximated 0.33 gram

### Package outline

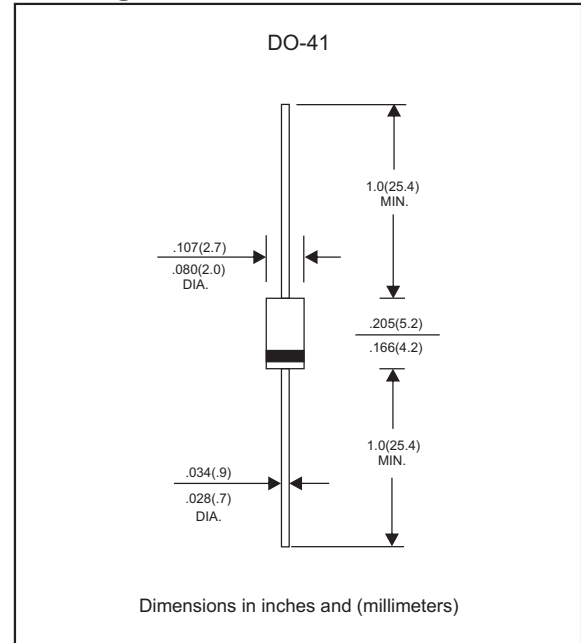

### Maximum ratings and Electrical Characteristics (AT $T_A=25^{\circ}\text{C}$ unless otherwise noted)

PARAMETER	CONDITIONS	Symbol	MIN.	TYP.	MAX.	UNIT
Forward rectified current	See Fig.1	$I_o$			1.0	A
Forward surge current	8.3ms single half sine-wave (JEDEC methode)	$I_{FSM}$			30	A
Reverse current	$V_R = V_{RRM} T_J = 25^{\circ}\text{C}$	$I_R$			5.0	$\mu\text{A}$
	$V_R = V_{RRM} T_J = 125^{\circ}\text{C}$				50	
Thermal resistance	Junction to ambient, note 1	$R_{\theta JA}$		50		$^{\circ}\text{C}/\text{W}$
Diode junction capacitance	f=1MHz and applied 4V DC reverse voltage	$C_J$		10		pF
Storage temperature		$T_{STG}$	-65		+175	$^{\circ}\text{C}$

SYMBOLS	$V_{RRM}^{*1}$ (V)	$V_{RMS}^{*2}$ (V)	$V_R^{*3}$ (V)	$V_F^{*4}$ (V)	Operating temperature $T_J$ , ( $^{\circ}\text{C}$ )
1N4001G	50	35	50	1.10	-55 to +150
1N4002G	100	70	100		
1N4003G	200	140	200		
1N4004G	400	280	400		
1N4005G	600	420	600		
1N4006G	800	560	800		
1N4007G	1000	700	1000		

- \*1 Repetitive peak reverse voltage
- \*2 RMS voltage
- \*3 Continuous reverse voltage
- \*4 Maximum forward voltage@ $I_F=1.0\text{A}$

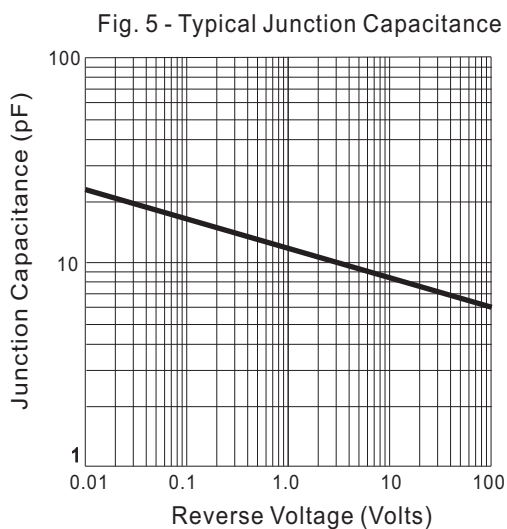
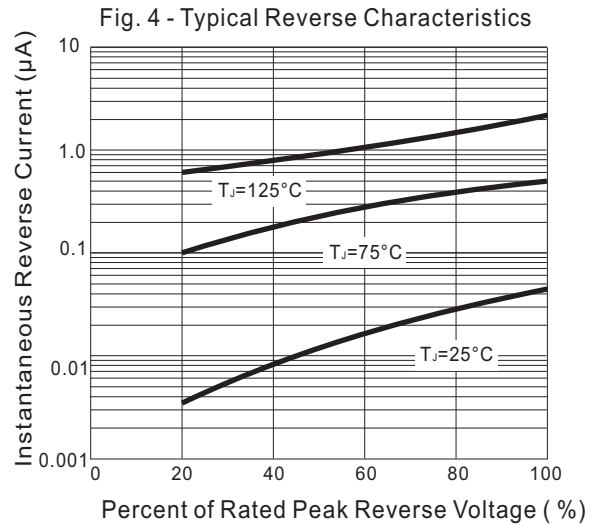
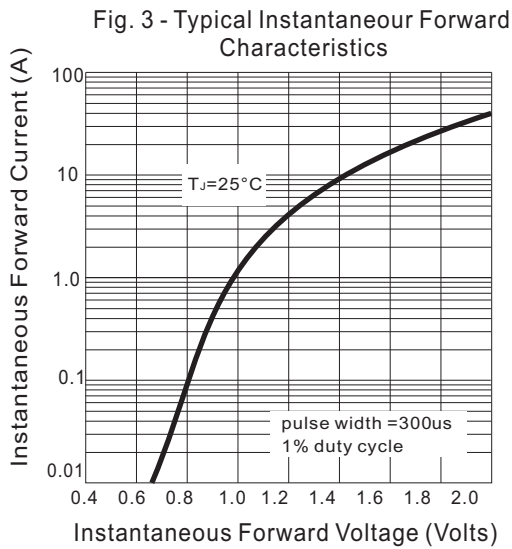
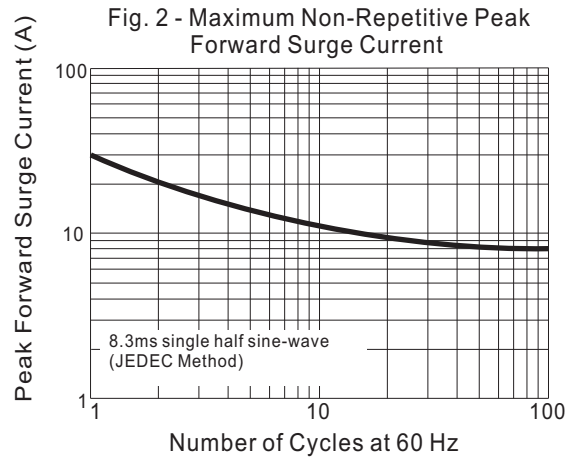
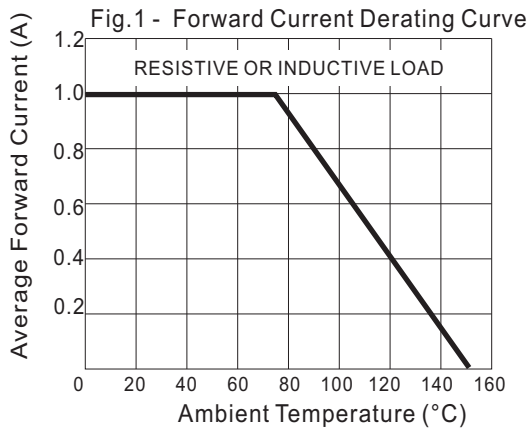

Notes: 1. Thermal resistance from junction to ambient at 0.375" (9.5mm) lead length, P.C.B. mounted

## Rating and characteristic curves (1N4001G THRU 1N4007G)



# 1N4001G THRU 1N4007G

## Pinning information

Pin	Simplified outline	Symbol
Pin1 cathode Pin2 anode		

## Marking

Type number	Marking code
1N4001G	1N4001G
1N4002G	1N4002G
1N4003G	1N4003G
1N4004G	1N4004G
1N4005G	1N4005G
1N4006G	1N4006G
1N4007G	1N4007G

## Taping & bulk specifications for AXIAL devices

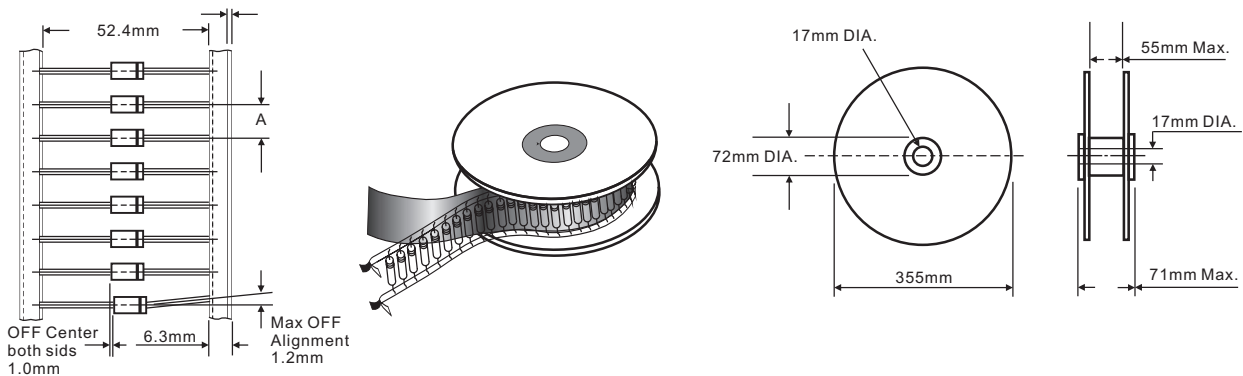

### REEL PACKING

DEVICE CASE TYPE	Q'TY 1 (PCS / REEL)	COMPONENT SPACING "A" in FIG. A	CARTON SIZE	Q'TY 2 (PCS / CARTON)	APPROX. CROSS WEIGHT(kg)
DO-41	5,000	5 mm	360 * 340 * 370	20,000	10.8

### AMMO PACKING

DEVICE CASE TYPE	Q'TY 1 (PCS / BOX)	INNER BOX SIZE (m/m)	CARTON SIZE (m/m)	Q'TY 2 (PCS / CARTON)	APPROX. CROSS WEIGHT(kg)
DO-41	5,000	260 * 83 * 160	440 * 270 * 340	50,000	20.0

# 1N4001G THRU 1N4007G

BULK PACKING

DEVICE CASE TYPE	Q'TY 1 (PCS / BOX)	INNER BOX SIZE (m/m)	CARTON SIZE (m/m)	Q'TY 2 (PCS / CARTON)	APPROX. CROSS WEIGHT(kg)
DO-41	1,000	194 * 84 * 20	465 * 220 * 260	50,000	20.6

**Suggested thermal profiles for soldering processes**

1. Lead free temperature profile wave-soldering

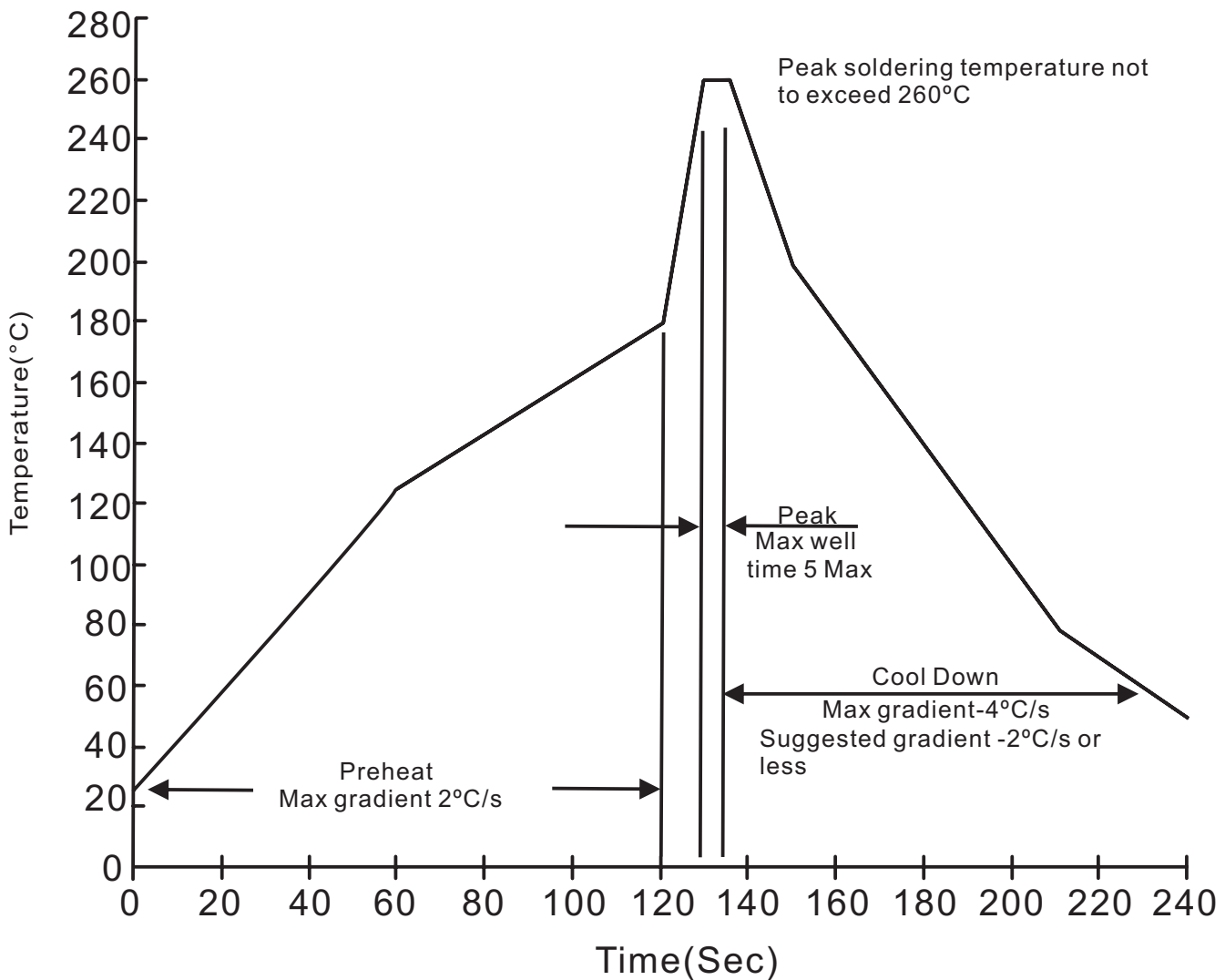

**1N4001G THRU 1N4007G****High reliability test capabilities**

Item Test	Conditions	Reference
1. Solder Resistance	at 260±5°C for 10±2sec. immerse body into solder 1/16"±1/32"	MIL-STD-750D METHOD-2031
2. Solderability	at 245±5°C for 5 sec.	MIL-STD-202F METHOD-208
3. Pull Test	1.0kg in axial lead direction for 10 sec. $I_F = I_O$	MIL-STD-202F METHOD-211A
4. Bend Lead	1.0kg weight applied to each lead bending arc 90°±5° for 3 times	MIL-STD-202F METHOD-211A
5. High Temperature Reverse Bias	$V_R = 80\%$ rate at $T_J = 150^\circ\text{C}$ for 168 hrs.	MIL-STD-750D METHOD-1038
6. Forward Operation Life	Rated average rectifier current at $T_A = 25^\circ\text{C}$ for 500hrs. $T_A = 25^\circ\text{C}$ , $I_F = I_O$	MIL-STD-750D METHOD-1027
7. Intermittent Operation Life	On state: power on for 5 min. off state: power off for 5 min, on and off for 500 cycles.	MIL-STD-750D METHOD-1036
8. Pressure Cooker	15P <sub>sig</sub> at $T_A = 121^\circ\text{C}$ for 4 hrs.	JESD22-A102
9. Temperature Cycling	-55°C to +125°C dwelled for 30 min. and transferred for 5min. total 10 cycles.	MIL-STD-750D METHOD-1051
10. Forward Surge	8.3ms single half sine-wave one surge.	MIL-STD-750D METHOD-4066-2
11. Humidity	at $T_A = 85^\circ\text{C}$ , RH=85% for 1000hrs.	MIL-STD-750D METHOD-1021
12. High Temperature Storage Life	at 175°C for 1000 hrs.	MIL-STD-750D METHOD-1031