

## 74VHC595 8-Bit Shift Register with Output Latches

### General Description

The VHC595 is an advanced high-speed CMOS Shift Register fabricated with silicon gate CMOS technology. It achieves the high-speed operation similar to equivalent Bipolar Schottky TTL while maintaining the CMOS low power dissipation.

This device contains an 8-bit serial-in, parallel-out shift register that feeds an 8-bit D-type storage register. The storage register has eight 3-STATE outputs. Separate clocks are provided for both the shift register and the storage register. The shift register has a direct-overriding clear, serial input, and serial output (standard) pins for cascading. Both the shift register and storage register use positive-edge triggered clocks. If both clocks are connected together, the shift register state will always be one clock pulse ahead of the storage register.

An input protection circuit insures that 0V to 7V can be applied to the input pins without regard to the supply voltage. This device can be used to interface 5V to 3V systems and two supply systems such as battery backup. This circuit prevents device destruction due to mismatched supply and input voltages.

### Features

- High Speed:  $t_{PD} = 5.4$  ns (typ) at  $V_{CC} = 5V$
- Low power dissipation:  $I_{CC} = 4$   $\mu A$  (max) at  $T_A = 25^\circ C$
- High noise immunity:  $V_{NIH} = V_{NIL} = 28\% V_{CC}$  (min)
- Power down protection is provided on all inputs
- Low noise:  $V_{OLP} = 0.9V$  (typ)
- Pin and function compatible with 74HC595

### Ordering Code:

Order Number	Package Number	Package Description
74VHC595M	M16A	16-Lead Small Outline Integrated Circuit (SOIC), JEDEC MS-012, 0.150 Narrow
74VHC595SJ	M16D	16-Lead Small Outline Package (SOP), EIAJ TYPE II, 5.3mm Wide
74VHC595MTC	MTC16	16-Lead Thin Shrink Small Outline Package (TSSOP), JEDEC MO-153, 4.4mm Wide
74VHC595N	N16E	16-Lead Plastic Dual-In-Line Package (PDIP), JEDEC MS-001, 0.300 Wide

Surface mount packages are also available on Tape and Reel. Specify by appending the suffix letter "X" to the ordering code.

### Logic Symbol

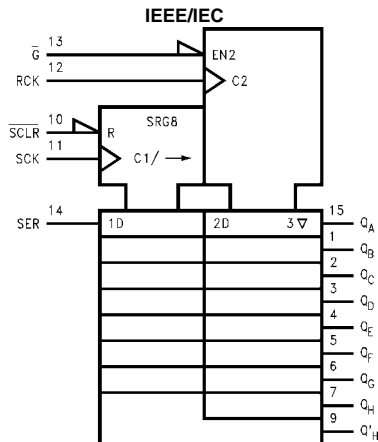

### Connection Diagram

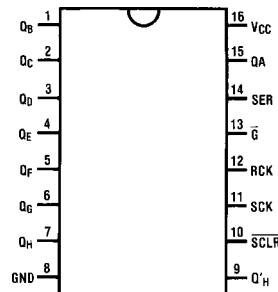

**Pin Descriptions**

Pin Names	Description
SER	Serial Data Input
SCK	Shift Register Clock Input (Active rising edge)
RCK	Storage Register Clock Input (Active rising edge)
$\overline{\text{SCLR}}$	Reset Input
$\overline{\text{G}}$	3-STATE Output Enable Input (Active LOW)
$Q_A - Q_H$	Parallel Data Outputs
$Q'_H$	Serial Data Output

**Truth Table**

Inputs					Function
SER	RCK	SCK	$\overline{\text{SCLR}}$	$\overline{\text{G}}$	
X	X	X	X	H	$Q_A$ thru $Q_H$ 3-STATE
X	X	X	X	L	$Q_A$ thru $Q_H$ outputs enabled
X	X	X	L	L	Shift Register cleared $Q'_H = 0$
L	X	↑	H	L	Shift Register clocked $Q_N = Q_{n-1}, Q_0 = \text{SER} = L$
H	X	↑	H	L	Shift Register clocked $Q_N = Q_{n-1}, Q_0 = \text{SER} = H$
X	↑	X	H	L	Contents of Shift Register transferred to output latches

**Timing Diagram**

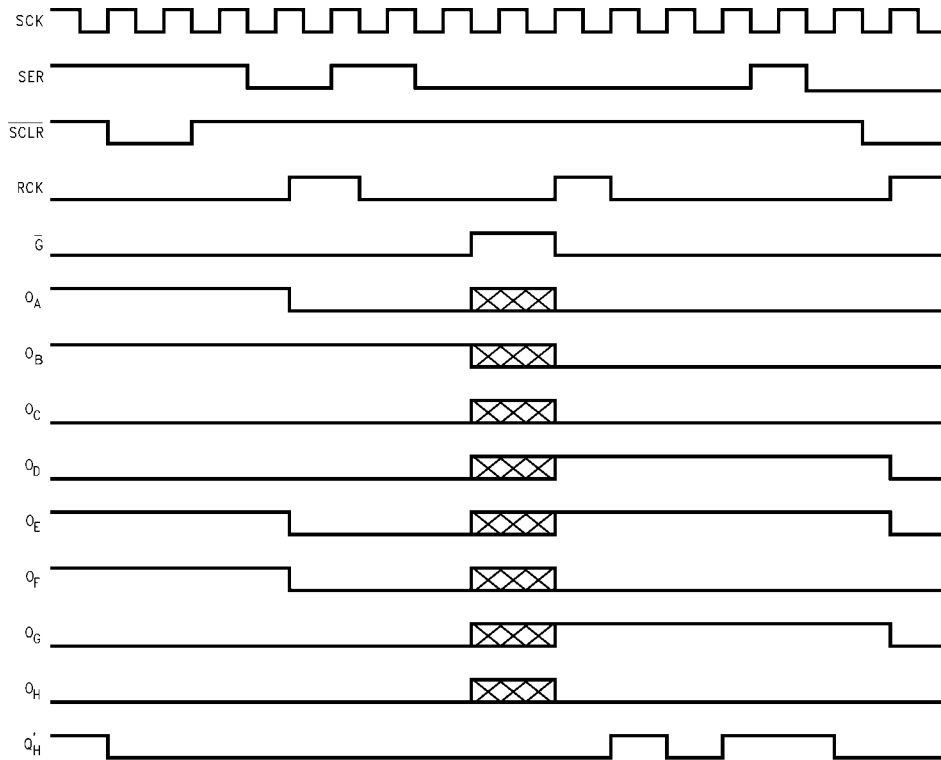

NOTE:  implies that the output is in 3-STATE mode.

### Logic Diagram

(positive logic)

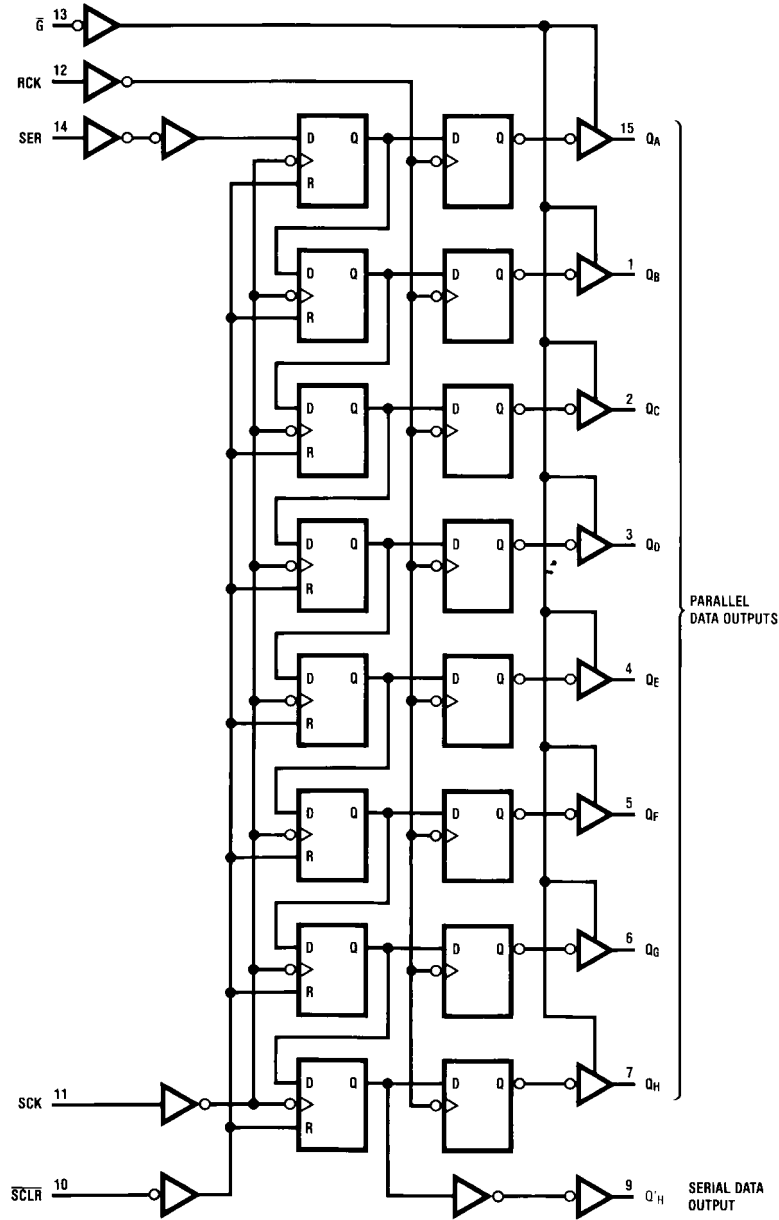

**Absolute Maximum Ratings** (Note 1)

Supply Voltage ( $V_{CC}$ )	-0.5V to +7.0V
DC Input Voltage ( $V_{IN}$ )	-0.5V to +7.0V
DC Output Voltage ( $V_{OUT}$ )	-0.5V to $V_{CC} + 0.5V$
Input Diode Current ( $I_{IK}$ )	-20 mA
Output Diode Current ( $I_{OK}$ )	$\pm 20$ mA
DC Output Current ( $I_{OUT}$ )	$\pm 25$ mA
DC $V_{CC}$ /GND Current ( $I_{CC}$ )	$\pm 75$ mA
Storage Temperature ( $T_{STG}$ )	-65°C to +150°C
Lead Temperature ( $T_L$ ) (Soldering, 10 seconds)	260°C

**Recommended Operating Conditions** (Note 2)

Supply Voltage ( $V_{CC}$ )	2.0V to +5.5V
Input Voltage ( $V_{IN}$ )	0V to +5.5V
Output Voltage ( $V_{OUT}$ )	0V to $V_{CC}$
Operating Temperature ( $T_{OPR}$ )	-40°C to +85°C
Input Rise and Fall Time ( $t_r, t_f$ )	
$V_{CC} = 3.3V \pm 0.3V$	0 ~ 100 ns/V
$V_{CC} = 5.0V \pm 0.5V$	0 ~ 20 ns/V

**Note 1:** Absolute Maximum Ratings are values beyond which the device may be damaged or have its useful life impaired. The databook specifications should be met, without exception, to ensure that the system design is reliable over its power supply, temperature, and output/input loading variables. Fairchild does not recommend operation outside databook specifications.

**Note 2:** Unused inputs must be held HIGH or LOW. They may not float.

**DC Electrical Characteristics**

Symbol	Parameter	$V_{CC}$ (V)	$T_A = 25^\circ\text{C}$			$T_A = -40^\circ\text{C to } +85^\circ\text{C}$		Units	Conditions	
			Min	Typ	Max	Min	Max			
$V_{IH}$	HIGH Level Input Voltage	2.0 3.0 – 5.5	1.50			1.50		V		
$V_{IL}$	LOW Level Input Voltage	2.0 3.0 – 5.5			0.50 0.3 $V_{CC}$	0.50 0.3 $V_{CC}$		V		
$V_{OH}$	HIGH Level Output Voltage	2.0	1.9	2.0		1.9		V	$V_{IN} = V_{IH}$ or $V_{IL}$	$I_{OH} = -50 \mu\text{A}$
		3.0	2.9	3.0		2.9				
		4.5	4.4	4.5		4.4				
		3.0	2.58			2.48		V		$I_{OH} = -4 \text{ mA}$
$V_{OL}$	LOW Level Output Voltage	2.0		0.0	0.1		0.1	V	$V_{IN} = V_{IH}$ or $V_{IL}$	$I_{OL} = 50 \mu\text{A}$
		3.0		0.0	0.1		0.1			
		4.5		0.0	0.1		0.1			
		3.0			0.36		0.44	V		$I_{OL} = 4 \text{ mA}$
$I_{OZ}$	3-STATE Output Off-State Current	5.5			$\pm 0.25$		$\pm 2.5$	$\mu\text{A}$	$V_{IN} = V_{CC}$ or GND $V_{OUT} = V_{CC}$ or GND $V_{IN\bar{G}} = V_{IH}$ or $V_{IL}$	$I_{OL} = 8 \text{ mA}$
$I_{IN}$	Input Leakage Current	0 – 5.5			$\pm 0.1$		$\pm 1.0$	$\mu\text{A}$		$V_{IN} = 5.5V$ or GND
$I_{CC}$	Quiescent Supply Current	5.5			4.0		40.0	$\mu\text{A}$		$V_{IN} = V_{CC}$ or GND

**Noise Characteristics**

Symbol	Parameter	$V_{CC}$ (V)	$T_A = 25^\circ\text{C}$		Units	Conditions
			Typ	Limits		
$V_{OLP}$ (Note 3)	Quiet Output Maximum Dynamic $V_{OL}$	5.0	0.9	1.2	V	$C_L = 50 \text{ pF}$
$V_{OLV}$ (Note 3)	Quiet Output Minimum Dynamic $V_{OL}$	5.0	-0.9	-1.2	V	$C_L = 50 \text{ pF}$
$V_{IHD}$ (Note 3)	Minimum HIGH Level Dynamic Input Voltage	5.0		3.5	V	$C_L = 50 \text{ pF}$
$V_{ILD}$ (Note 3)	Maximum LOW Level Dynamic Input Voltage	5.0		1.5	V	$C_L = 50 \text{ pF}$

**Note 3:** Parameter guaranteed by design.

AC Electrical Characteristics									
Symbol	Parameter	V <sub>CC</sub> (V)	T <sub>A</sub> = +25°C			T <sub>A</sub> = -40°C to +85°C		Units	Conditions
			Min	Typ	Max	Min	Max		
t <sub>PLH</sub>	Propagation Delay Time RCK to Q <sub>A</sub> -Q <sub>H</sub>	3.3 ± 0.3	7.7	11.9	1.0	13.5	ns	C <sub>L</sub> = 15 pF	
t <sub>PHL</sub>			10.2	15.4	1.0	17.0		C <sub>L</sub> = 50 pF	
		5.0 ± 0.5	5.4	7.4	1.0	8.5	ns	C <sub>L</sub> = 15 pF	
			6.9	9.4	1.0	10.5		C <sub>L</sub> = 50 pF	
t <sub>PLH</sub>	Propagation Delay Time SCK-Q'H	3.3 ± 0.3	8.8	13.0	1.0	15.0	ns	C <sub>L</sub> = 15 pF	
t <sub>PHL</sub>			11.3	16.5	1.0	18.5		C <sub>L</sub> = 50 pF	
		5.0 ± 0.5	6.2	8.2	1.0	9.4	ns	C <sub>L</sub> = 15 pF	
			7.7	10.2	1.0	11.4		C <sub>L</sub> = 50 pF	
t <sub>PHL</sub>	Propagation Delay Time SCLR-Q'H	3.3 ± 0.3	8.4	12.8	1.0	13.7	ns	C <sub>L</sub> = 15 pF	
			10.9	16.3	1.0	17.2		C <sub>L</sub> = 50 pF	
		5.0 ± 0.5	5.9	8.0	1.0	9.1	ns	C <sub>L</sub> = 15 pF	
			7.4	10.0	1.0	11.1		C <sub>L</sub> = 50 pF	
t <sub>PZL</sub>	Output Enable Time $\bar{G}$ to Q <sub>A</sub> -Q <sub>H</sub>	3.3 ± 0.3	7.5	11.5	1.0	13.5	ns	R <sub>L</sub> = 1 kΩ C <sub>L</sub> = 15 pF	
t <sub>PZH</sub>			9.0	15.0	1.0	17.0		C <sub>L</sub> = 50 pF	
		5.0 ± 0.5	4.8	8.6	1.0	10.0	ns	C <sub>L</sub> = 15 pF	
			8.3	10.6	1.0	12.0		C <sub>L</sub> = 50 pF	
t <sub>PLZ</sub>	Output Disable Time $\bar{G}$ to Q <sub>A</sub> -Q <sub>H</sub>	3.3 ± 0.3	12.1	15.7	1.0	16.2	ns	R <sub>L</sub> = 1 kΩ C <sub>L</sub> = 50 pF	
t <sub>PHZ</sub>		5.0 ± 0.5	7.6	10.3	1.0	11.0		C <sub>L</sub> = 50 pF	
f <sub>MAX</sub>	Maximum Clock Frequency	3.3 ± 0.3	80	150	70		MHz	C <sub>L</sub> = 15 pF	
			55	130	50			C <sub>L</sub> = 50 pF	
		5.0 ± 0.5	135	185	115		MHz	C <sub>L</sub> = 15 pF	
			95	155	85			C <sub>L</sub> = 50 pF	
t <sub>OSLH</sub>	Output to Output Skew	3.3 ± 0.3		1.5		1.5	ns	(Note 4) C <sub>L</sub> = 50 pF	
t <sub>OSSL</sub>		5.0 ± 0.5		1.0		1.0		C <sub>L</sub> = 50 pF	
C <sub>IN</sub>	Input Capacitance		5.0	10		10	pF	V <sub>CC</sub> = Open	
C <sub>OUT</sub>	Output Capacitance		6.0				pF	V <sub>CC</sub> = 5.0V	
C <sub>PD</sub>	Power Dissipation Capacitance		87				pF	(Note 5)	

**Note 4:** Parameter guaranteed by design. t<sub>OSLH</sub> = |t<sub>PLH</sub> max - t<sub>PLH</sub> min|; t<sub>OSSL</sub> = |t<sub>PHL</sub> max - t<sub>PHL</sub> min|.

**Note 5:** C<sub>PD</sub> is defined as the value of the internal equivalent capacitance which is calculated from the operating current consumption without load. Average operating current can be obtained by the equation: I<sub>CC</sub> (opr.) = C<sub>PD</sub> \* V<sub>CC</sub> \* f<sub>IN</sub> + I<sub>CC</sub>.

## AC Operating Requirements

Symbol	Parameter	V <sub>CC</sub> (V)	T <sub>A</sub> = 25°C		T <sub>A</sub> = -40°C to +85°C	Units
			Typ	Guaranteed Minimum		
t <sub>S</sub>	Minimum Setup Time (SER-SCK)	3.3 ± 0.3		3.5	3.5	ns
		5.0 ± 0.5		3.0	3.0	
t <sub>S</sub>	Minimum Setup Time (SCK-RCK)	3.3 ± 0.3		8.0	8.5	ns
		5.0 ± 0.5		5.0	5.0	
t <sub>S</sub>	Minimum Setup Time ( $\overline{\text{SCLR}}$ -RCK)	3.3 ± 0.3		8.0	9.0	ns
		5.0 ± 0.5		5.0	5.0	
t <sub>H</sub>	Minimum Hold Time (SER-SCK)	3.3 ± 0.3		1.5	1.5	ns
		5.0 ± 0.5		2.0	2.0	
t <sub>H</sub>	Minimum Hold Time (SCK-RCK)	3.3 ± 0.3		0.0	0.0	ns
		5.0 ± 0.5		0.0	0.0	
t <sub>H</sub>	Minimum Hold Time ( $\overline{\text{SCLR}}$ -RCK)	3.3 ± 0.3		0.0	0.0	ns
		5.0 ± 0.5		0.0	0.0	
t <sub>W(L)</sub>	Minimum Pulse Width (SCLR)	3.3 ± 0.3		5.0	5.0	ns
		5.0 ± 0.5		5.0	5.0	
t <sub>W(L)</sub>	Minimum Pulse Width (SCK)	3.3 ± 0.3		5.0	5.0	ns
t <sub>W(H)</sub>	Minimum Pulse Width (RCK)	5.0 ± 0.5		5.0	5.0	ns
t <sub>W(L)</sub>	Minimum Pulse Width (RCK)	3.3 ± 0.3		5.0	5.0	ns
t <sub>W(H)</sub>	Minimum Pulse Width (SCK)	5.0 ± 0.5		5.0	5.0	ns
t <sub>rem</sub>	Minimum Removal Time ( $\overline{\text{SCLR}}$ -SCK)	3.3 ± 0.3		3.0	3.0	ns
		5.0 ± 0.5		2.5	2.5	

**Physical Dimensions** inches (millimeters) unless otherwise noted

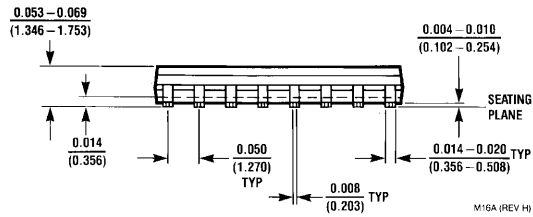
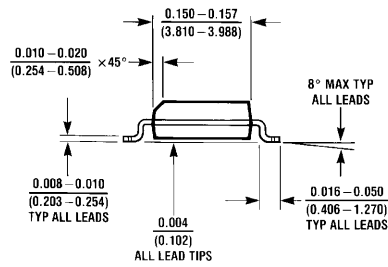
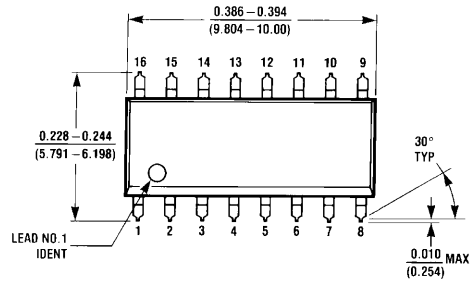

**16-Lead Small Outline Integrated Circuit (SOIC), JEDEC MS-012, 0.150 Narrow Package Number M16A**

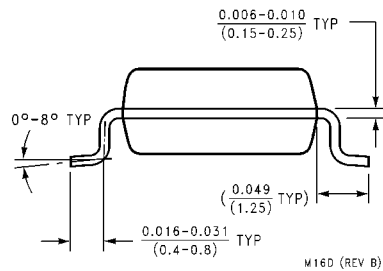
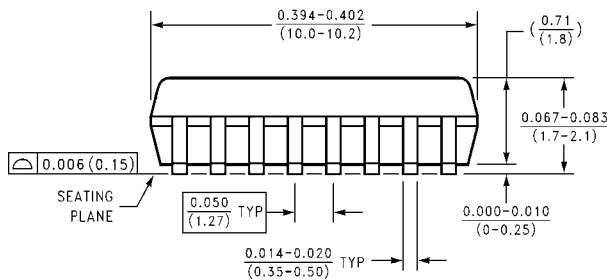
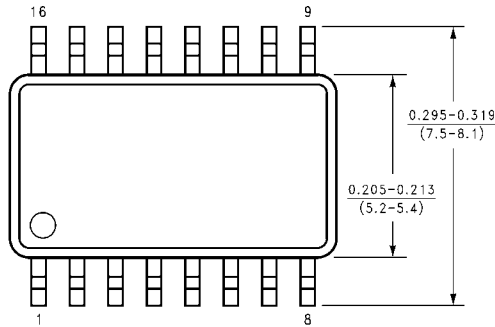

**16-Lead Small Outline Package (SOP), EIAJ TYPE II, 5.3mm Wide Package Number M16D**

**Physical Dimensions** inches (millimeters) unless otherwise noted (Continued)

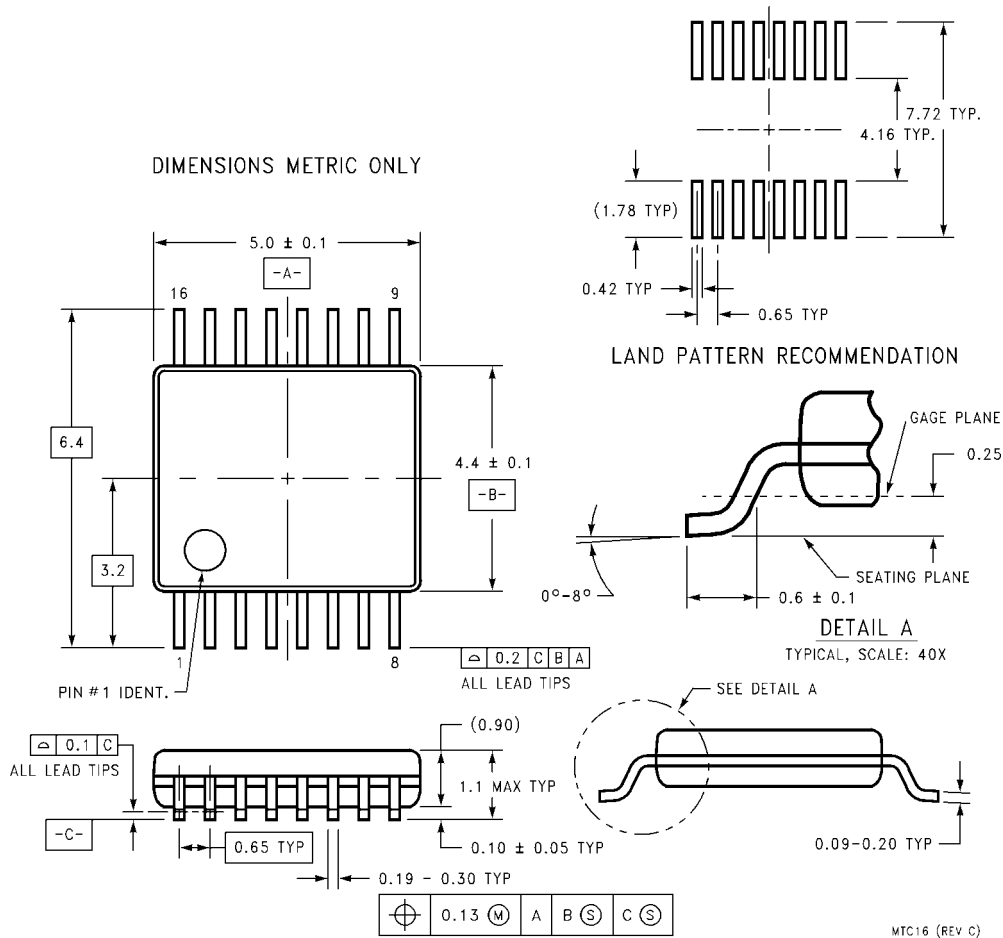

**16-Lead Thin Shrink Small Outline Package (TSSOP), JEDEC MO-153, 4.4mm Wide  
Package Number MTC16**



